

XTENSION

Price List
CANADA 2023



logiflex

Table of Contents

Introduction	3	Supports	54
Product Map	5	Legs	55
Our social responsibility	8	Layering Surface Support	61
Conditions of Sale	8	Brackets and Stiffeners	63
Manufacturing Standards	9	Pedestals	68
How to Use the Price List	10	Independent Pedestals	69
Appendix A: Colors and Finishes	11	Mobile Pedestals	77
Appendix B: Surfaces and Molding Edges	14	High Pedestals	79
Appendix C: Wood Grain	15	Benches	81
Appendix D: Pedestals and File Drawers	16	Storage Towers	84
Appendix E: Calculation and Use of Electrical Components	17	Sliding Storages	85
Appendix F: Locks	20	Storage Towers	86
Appendix G: Electrical Wire Management Solutions	21	Islands Stations	89
Appendix H: Surface Support	24	Islands Stations	90
Walls and Panels	25	Islands Stations with Bookcase	91
Power Walls	26	Islands Stations with Lockers	92
Division Panels	31	Accessories	93
Panel Accessories	38	Keyboard Trays	95
Surfaces	48	CPU Holders	96
Rectangular Surfaces	49	Computer Monitor Brackets	97
D Surfaces	51	Miscellaneous Accessories	99
Collaboration Surfaces	52	Electrical Accessories	101
Privacy Corner Screen	53		

Introduction

The Xtension furniture collection

Update Summary

The Xtension price list presents these principal modifications:

DATE	SECTION	MODIFICATIONS
July 4, 2023	Electrical accessories	<ul style="list-style-type: none">Chicago Code : Certain electrical components are now marked prohibited or restricted for orders in Chicago. (USA pricelist only).

Previous updates:

DATE	SECTION	MODIFICATIONS
May 22, 2023	Panels	<ul style="list-style-type: none">Addition of new dimensions for panels PANLL, PANLR, PANT and PANX.
February 1, 2023	All the Price List	<ul style="list-style-type: none">All prices have been increased by approximately 5%.Transition from 6 to 14 grades of fabric.New certification Indoor Advantage Gold (replace Greenguard).
December 1, 2022	Electrical accessories	<ul style="list-style-type: none">Adjustment of the names and images of certain items.
July 1, 2022	Appendix A	<ul style="list-style-type: none">Color availability chart update for the HPL.

Introduction



Product Map

Walls and Panels

*Do not mix Xtension with other collections
[See the Xtension specifications guide here](#)

Power Walls

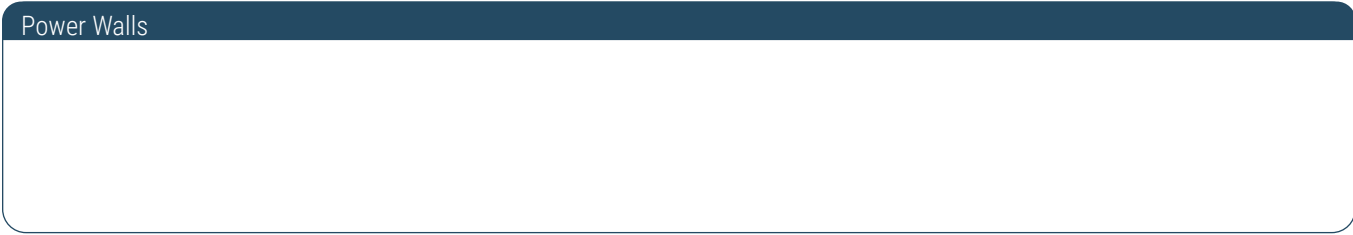

Division Panels

p.34

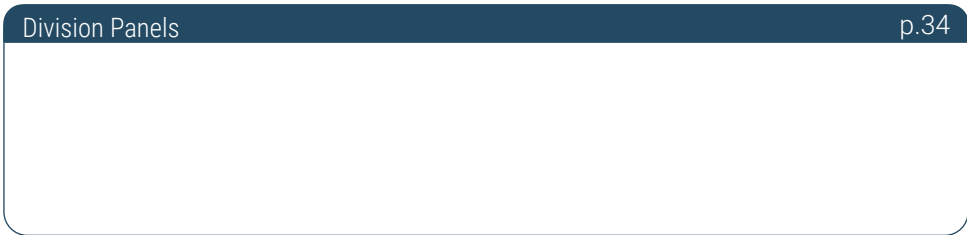

Panel Accessories

p.38

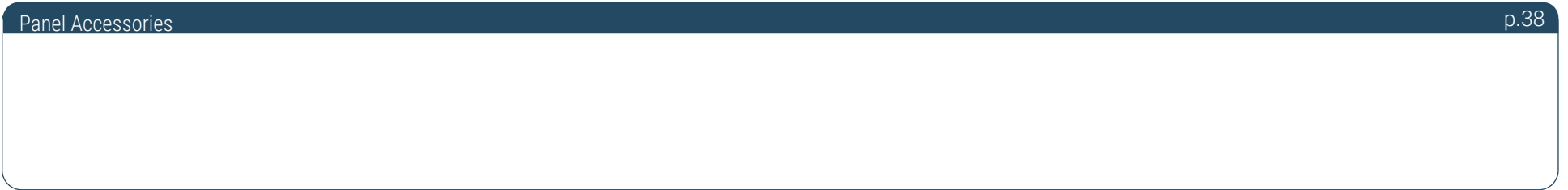

Surfaces

Rectangular Surfaces

p.48



Privacy Corner Screen

p.52

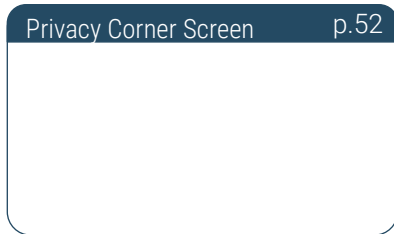

Introduction

Product Map

Supports

*Do not mix Xtension with other collections

[See the Xtension specifications guide here](#)

Legs

p.54

Layering Surface Support

p.60

Brackets and Stiffeners

p.62

Pedestals

Independant Pedestals

p.68

Mobile Pedestals

p.76

High Pedestal

p.78

Introduction

Product Map

Pedestals (following)

*Do not mix Xtension with other collections
[See the Xtension specifications guide here](#)

Benches

p.79

Storage Towers

Sliding Storages

p.84

Storage Towers

p.85

Islands Stations

Islands Stations

p.88



Our social responsibility

At Logiflex, we have chosen to be a responsible North American manufacturer by implementing initiatives for sustainable development. As much as possible, we source local materials and partner with suppliers who prioritize clean manufacturing processes. We also consolidate goods during transport to reduce fuel consumption and we continually make changes that help reduce our waste production.

The company is ISO 9001 certified.

You can consult our eco-responsible approach as well as all our certifications in the [Certifications](#) section of our website. Find out how our products can help you obtain LEED credits and the Logiflex products that are Indoor Advantage Gold certified.

Conditions of Sale

Prices

The amounts listed in this document are suggested retail prices and may be changed without notice. Applicable taxes are not included. If you have an open and active account with Logiflex, merchandise will be invoiced at the prices prevailing at the time of shipment. A deposit may be requested if the opening of your account has not been completed or if your account has become inactive.

Terms of Payment

Net 30 days F.O.B. Sherbrooke, Quebec. The invoice will be assigned the shipping date and is payable 30 days from that date. Logiflex remains the owner of the merchandise until the invoice is paid in full.

Customized Products (Special Items)

Price requests for customized products or special items can be submitted via the ["Private Space"](#) section of our website, at www.logiflex.ca. Our quotations department will study your request and send you a quotation and a technical drawing for approval as soon as possible. Modifications to quotations or technical drawings can be requested the same way. The approved quotation(s) and technical drawing(s) can then be attached to your purchase order.

Orders

An official purchase order must be issued for all purchases. Your purchase order must contain the following information:

- Your company letterhead
- Your reference number
- The delivery address (with contact name and phone number)
- The complete product codes
- Furniture colour(s)
- Quantities
- Descriptions
- Retail prices and net prices
- Project registration number (if applicable), and your approved quotation and technical drawing (for special items).

Please note that a quotation cannot serve as a purchase order.

Returns

All returns must first be approved by Logiflex. If the return is accepted, a Logiflex customer service representative will send you an official return authorization form in order to facilitate procedures between you, the carrier, and the Logiflex merchandise reception clerk. Additional costs for shipping or other expenses may be applied following any merchandise returns.

Modifications and/or Cancellations

You have 24 hours from the time we acknowledge receipt of your order to make any requests for corrections or modifications. You may cancel your order during this same 24-hour period. If you would like to modify or cancel your order after this 24-hour verification period, please check with a Logiflex customer service representative. Orders cannot be changed or cancelled if production has already begun or if Logiflex has already received the raw materials.

Liability

Logiflex's liability ends once the carrier has delivered all items in good condition. A delivery receipt signed by the customer acknowledges that the shipment is complete and has been received in good condition.

Claims

Logiflex recommends inspecting the shipment before signing the carrier's delivery receipt. You must notify Logiflex of any incomplete shipments or damaged furniture within 30 days after delivery. Requests to replace damaged products can be made via the ["Private Space"](#) section of our website, at www.logiflex.ca. Our after-sales service department will examine your request and help you correct the situation.

Changes

Logiflex reserves the right to make changes to the materials, accessories, components, specifications and designs, and to discontinue collections and/or models, at any time and without prior notice.

Storage and/or Shipping Fees

According to the terms Logiflex set forth in the transport policy. The transport policy can be consulted online in the Private Space.

Items Delivered Disassembled

Some items are delivered disassembled, such as empty desks, empty returns, bridges, arched tables, D, P or Q tables, lateral tables, end tables, hook tables, corner tables and extended-corner tables. To order these items assembled, add a \$100 list price. Contact Customer Service for details.

Warranty

Logiflex guarantees to the original purchaser that Logiflex products are free from defects in design, materials and workmanship for the product's lifetime, with certain exceptions.

You may consult the full warranty on the website: [Logiflex Warranty](#)

Introduction



Manufacturing Standards

Product Dimensions

For display purposes, the furniture dimensions represented in the price tables on each product page are rounded to the nearest whole number.

Furniture Construction

- All desktops and legs are 1" thick laminate;
- Fronts and backs are 5/8" thick laminate.

Handles

Handles are included for all Xtension furniture with doors. The standard handle, when included, is the H071BL handle (black). Please refer to the [Accessories](#) section for the list of handles available from Logiflex.

Space for surfaces

All surfaces offer the option of having a 1.5" space to allow wiring to pass through. Please refer to the different product pages to see and understand its operation.

Locks

Locks are included for all pedestals, lateral file drawers, cabinets and wardrobes. It is possible to specify a finish other than the black standard. Please refer to the [Accessories](#) section at the end of this price list to find out about the different finishes available from Logiflex.

Pedestals

All drawers are made of black Medium density fiberboard (MDF) with an average thickness of 7/16". Utility, file and lateral file drawers have full extension slides. The lateral file drawer has a load capacity of 150lbs while the utility and file drawer have a load capacity of 100lbs.

Drawer Fronts

A PVC strip 1.5 mm thick is systematically applied along all drawer front edges.

Wood Grain

The wood grain is always vertical on fronts, furniture doors, walls and panels. Logiflex cannot guarantee that the wood grain will match up on the different parts of a same surface.

Finishes

You must specify the desired finish(es) for each item of furniture ordered. Please make your selection(s) from the Logiflex chart.

Levelers

All furniture items sit on 1" in diameter, white nylon levelers, allowing for up to 1-1/4" height adjustment. The standard finished height for work surfaces is 29".

Introduction

How to Use the Price List

Interactive Menu
 Product line → Storage towers
 Product group → Sliding Storage
 Storage Towers

Product name → Cabinet with drawers
Product code → ARUFL ARUFR

Product image → [Isometric views of cabinet with dimensions A, B, C]

Product Information → Color Combination (Top, Front, Base)

Manufacturing Standards
 Cabinet with 1 door, 1 utility drawer and 1 lateral file drawer:
 • 1 cabinet section with 1 adjustable shelf for the 42"H cabinet with drawers, 2 adjustable shelves for the 54"H cabinet with drawers;
 • 1 utility drawer;
 • 1 lateral file drawer;
 • Handles H071BL;
 • Lock;
 • White nylon levelers.

Additional Product Information and Notes
 Remove lock as option, no extra charge.
 Specify if different handle desired (no extra charge, see p. XX).

Options
 Tab with notch for wire management
 MG \$0

Navigation Buttons (when blue) → [Previous View, Previous Page, Next Page, Product Map, Table of Contents]

Prices

Dimensions			
A	B	C	
20	18	42	1432
24	18	42	1458
20	18	54	1453
24	18	54	1480

Ordering instructions

	ABC	ARUFL ARUFR	MGRL MGRLR MGRR MGN (std)	H071BL (std)	N LKSN LKBL (std)	
Series	XT					
Dimensions						
Product			Tab with notch for wire management	Handle	Lock	
Example	XT	201842	ARUFR	MGN	H071BL	LKBL

June 13, 2022 | Canada LOGIFLEX | XTENSION 84

Standard Product Code
 Details as per the price listed

Options, if desired (\$)
 Always after the product code

Introduction



Appendix A: Colors and Finishes

How to specify your laminate colors

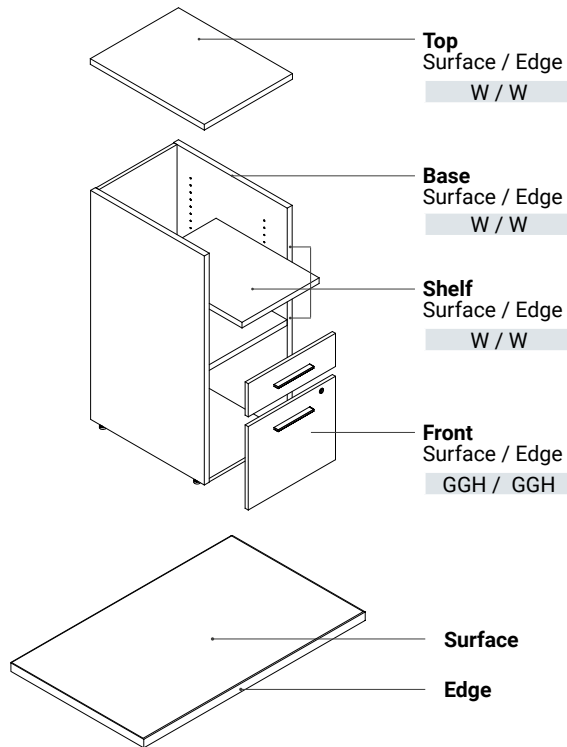

Metal Finishes

- SN** Satin Nickel
- BL** Black
- WH** White

Availability Chart

FINI FINISH	CODE	COLOR COULEUR	THICKNESS ÉPAISSEUR			HPL STRATIFIÉ	PANVAL CODE
			5/8"	1"	1-5/8"		
OMNIA	DOO	Dosha	•	•		•	K77
	COO	Cosmos	•	•		•	K78
AURA	GIA	Ginger Root Gingembre	•	•		•	H72
	HAA	Haze Brume	•	•	•	•	H57
	OHA	Ohm	•	•	•	•	K69
	STA	Storm Tempête	•	•	•	•	H58
	TUA	Tundra	•	•		•	H75
LYRA	ASY	Asha	•	•		•	K47
	CIY	Chiffon Mousseline **	•	•	•	•	K60
	KAY	Kali	•	•		•	K46
SUPERMAT	IGS	Ingot grey Gris lingot	•	•			828
	WGS	Willow grey Gris saule	•	•			802
DOLOMITE	AU	Audacity Audace **	•	•	•	•	241
	B	Jet Black Noir intense *	•	•		•	888 S405-CA
	BC	Brown cherry Cerisier brun	•	•	•	•	207
	C	Slate Ardoise *	•	•		•	801
	DR	Driftwood Bois de rive	•	•		•	744
	G	Mink Grey Gris vison	•	•		•	805 OU-927
	NM	Natural Maple Érable naturel	•	•	•	•	206
	PO	Porto	•	•		•	913 OU-648
	SW	Smoked Walnut Noyer fumé	•	•	•	•	G21
	TO	Tobacco	•	•		•	205
	W	Polar White Blanc polaire	•	•	•	•	555 459-CA
WK	Whisky	•	•	•	•	245	
HIGH GLOSS SUPER LUSTRE	W-H	Polar White - fronts Blanc polaire - façades	•				

* Non recommended color for work surfaces.

** For conference tables with 2 or more parts, we do not recommend the use of colors with irregular and contrasted woodgrain like Chiffon, Audacity or Coastal Pear as it results in a pronounced wood grain mismatch.

Colors may vary from 2% to 5% between tfl and hpl laminates due to different technical applications.

See our complete [Colors & Finishes Guide](#)

N New

Introduction

Appendix A: Colors and Finishes (following)

12 Wood Stains

Logiflex offers varnish and stain selection among the following 12 colors on all wood applications.

Knots and color variation can occur between different wood components of the same piece of furniture, or between different pieces of furniture. This variation is due to the natural characteristics of the wood, and is more contrasting for pale wood colors like Golden Wheat.



WW White Wash



GW Golden Wheat



SD Sand



AT Apricot



PN Pecan



BR Brandy



CT Chestnut



CF Coffee

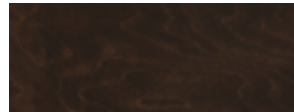

ES Espresso



BO Bordeaux



BW Black Wash



BK Bark

- Due to its natural properties of wood, grain pattern and finish color variation can be expected.
- Although Logiflex offers great matches from laminate to wood, they are not exact due to grain pattern and sheen variation from laminate to wood. They coordinate throughout a floor plan, however we recommend they not be utilized on the same piece of furniture. See the [Closest match - Wood stain / Laminate](#) guide.
- Adding a new product to an existing installation might result in color variations due to light exposure.
- **RAW** and **HATLEY** legs have a wood part.

3 Felt Colors for hexagonal tiles

Hexagonal felt tiles are 12" x 10-25/64" tiles covered with felt and are offered in a choice of 3 colors.



BL Blue



LG Light Grey



DG Dark Grey

10 Fabrics for Tackboards

You must specify the fabric when the item requires it. Please refer to the Logiflex fabric guide to make your choice.



TBFRME Medium Grey



TBFRGR Grey Mix



TBOFTH Thermal



TBOFCO Coal



TBOFTI Tidal



TBOFHY Hydro



TBOFLA Lava



TBOFFO Fossil



TBSPAL Alabaster



TBSPOB Obsidian

Cushions Fabrics

[See the Logiflex Graded-in List](#)

Introduction



Appendix A: Colors and Finishes (following)

15 Colors for Ezobord Sound Absorbing Overhead Screen

The Ezobord sound absorbing overhead screens are used to give an extra touch of privacy with a unique style and are offered in a choice of 15 colors.

2 Colors Available



BG07 Bold Gray



MG10 Moss Green

13 Other Colors Available, if Order 6 and More



PB09 Pure Black



CG06 Charcoal Gray



SG04 Silver Gray



CW04 Classic White



DS10 Desert Sand



SD18 Sunny Days



P114 Polar Ice



OB14 Ocean Blue



EG11 Elephant Gray



TB35 Tree Bark



BR34 Brick Red



GV36 Grape Vine



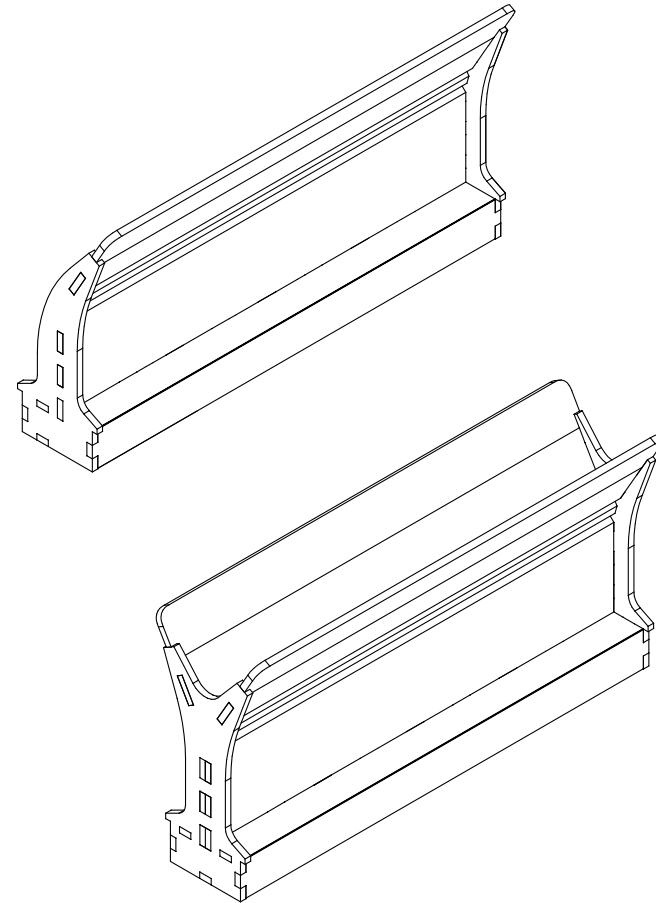

RB08 Royal Blue



• These colors only apply to sound absorbing overhead screens products with codes **OHSS** or **OHSD**.



Appendix B: Surfaces and Molding Edges

SERIES	PREVIEW	COMPONENT	MATERIAL	EDGES / MOLDING
XT		1" surface	Thermofused laminate (TFL) - 1" high-density particle board.	1.5 mm polyvinyl chloride (PVC)
XTL		1-1/16" surface	High pressure laminate (HPL) - 1" high-density particle board, 1/32" HPL sheet on surface, 1/32" balancing sheet under surface (prevents bending) with 2.5 mm PVC edge.	1.5 mm polyvinyl chloride (PVC)
		Front and back	Thermofused laminate (TFL) - 5/8" high-density particle board.	1.5 mm polyvinyl chloride (PVC) on showing surfaces and 0.5 mm polyvinyl chloride (PVC) on non-showing surfaces.

Introduction



Appendix C: Wood Grain

Wood grain runs lengthwise on surfaces and vertically on drawers, doors and legs.
See image below for wood grain direction placements.

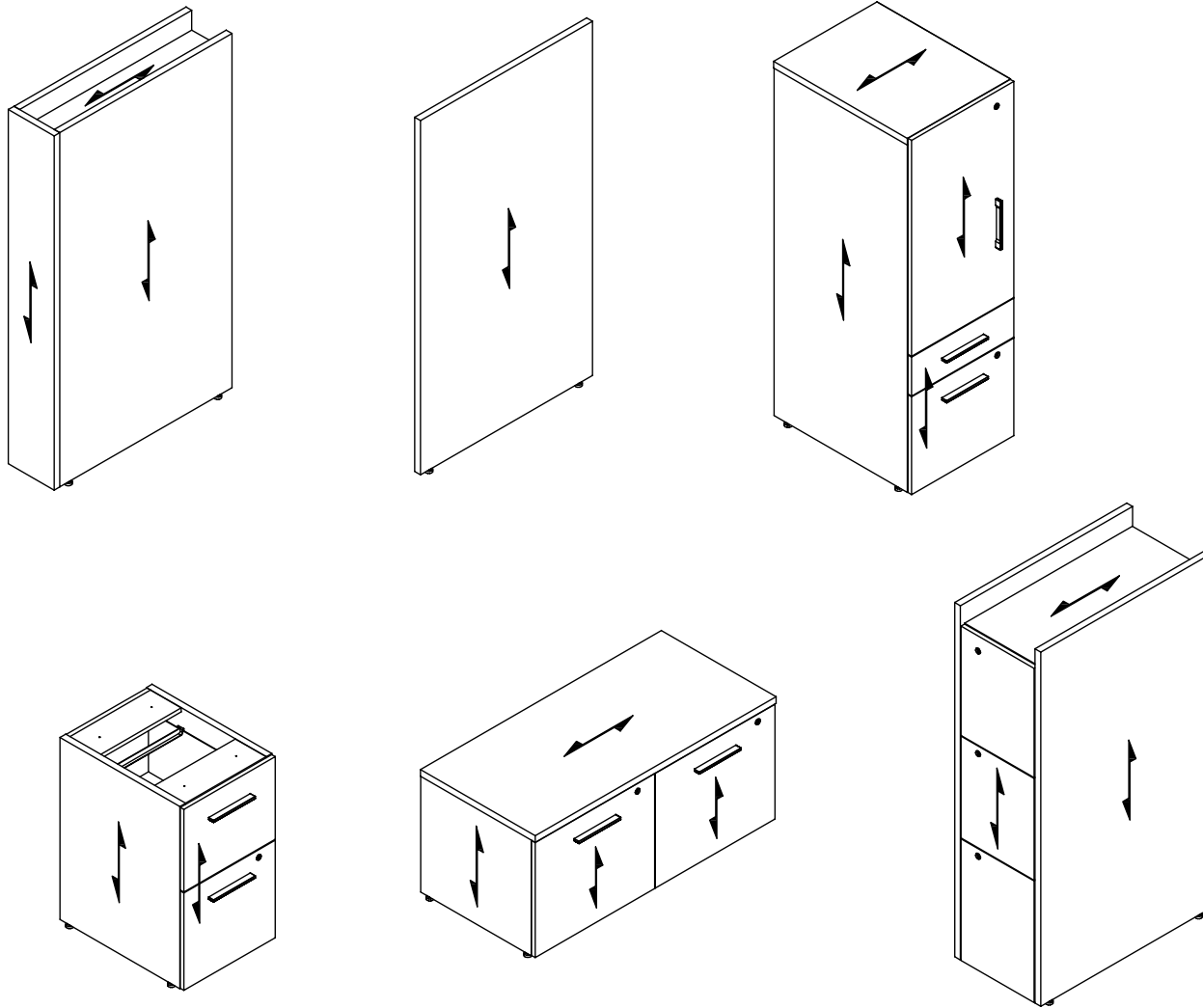

Introduction



Appendix D: Pedestals and File Drawers

E and F Pedestals

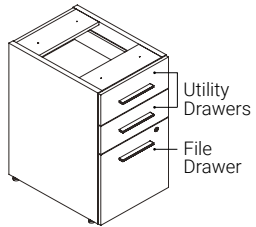

E

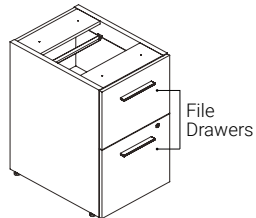

F

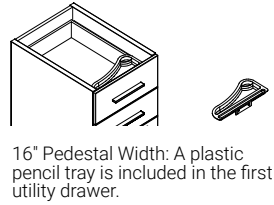

File Drawers

File drawers can receive either legal or letter formats. Please refer to the illustration below.

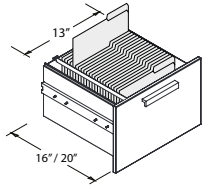

Letter format

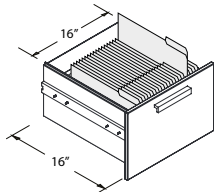

Legal format

Lateral File Drawers

Lateral file drawers can receive either legal or letter formats. Please refer to the illustration below.

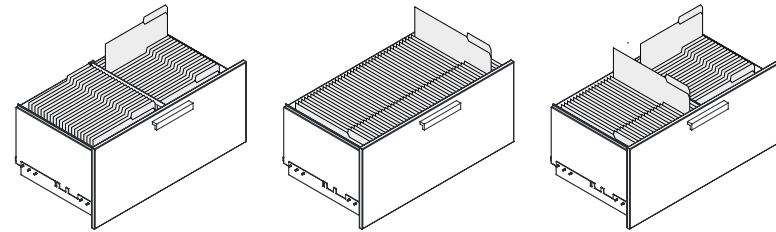

Legal and Letter formats

30" and 36" file drawers can accommodate 2 rows of files.
42" file drawers can accommodate 3 rows of files.

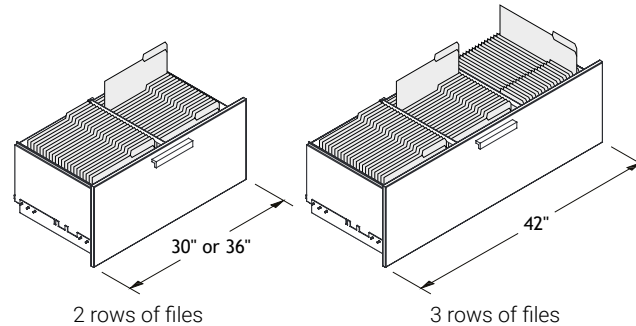

Appendix E: Calculation and Use of Electrical Components

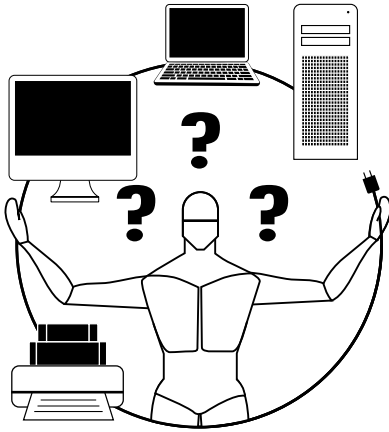

An Introduction to Calculation and Use of Electrical Components

Most people are uncomfortable with anything related to electricity. This step-by-step guide is intended for people who are not familiar with electrical installations but who have to specify what system they need when ordering furniture. In this guide, you will learn how to choose and specify the electrical components required for your projects. The list that follows illustrates and identifies each product and describes its applications.

The electrical components are all recognized by the Underwriters Laboratory (UL) as office furniture accessories and are manufactured according to Canadian Standards Association (CSA) and UL electrical standards.

Note: All electrical connections must be performed by a certified electrician.

By following these 3 simple steps, you can easily determine the number of circuits required to ensure safe use of your electrical system.

1. Determining the Number of Amperes Required
2. Calculating the Total Amperes
3. Determining How Many Circuits You Need

STEP 1: Determining the Number of Amperes Required

What is Amperage

An Ampere (Amp or A) is a unit for measuring the rate at which electric current flows. All electrical equipment has an amperage rate. By following these few simple steps, you can easily determine the number of circuits required to ensure safe use of your electrical equipment.

Determine the Number of Amperes Required

On your computer or other electric devices (ie: monitor, central processing unit, printer) find the plate that provides the technical specifications as follows:

Input: 120V - 1.8A.

If you cannot locate this information on the machine, you will probably find it in the user manual.

Here are a few examples of how many Amps some equipment may consume. Please note that these are examples and the number of amperes may vary from one machine to another.

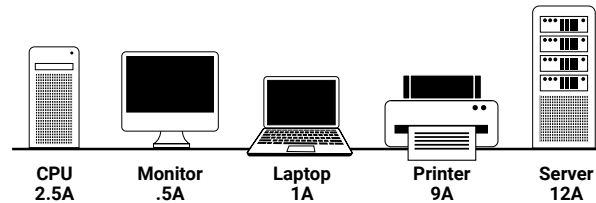

Electrical System Capacity

Our electrical system is designed for circuits of 20 amps each. This includes electrical components such as computers, printers, laptops, monitors, server or other devices.

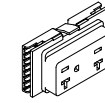

20A

A single Duplex has a maximum capacity of 20 A

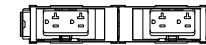

Each power block can hold 2 Duplex

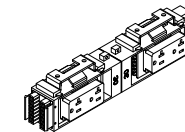

Each power block can hold 4 Duplex



If the duplexes are connected to the same circuit, the capacity is divided between them. For example, 3 duplexes connected to the same circuit have a total capacity of 20A.

Introduction

Appendix E: Calculation and Use of Electrical Components

STEP 2: Calculating the Total Amperes

Add the Amperes

Add the number of amps for each machine. In our example, there are 4 CPUs at 2.5A per computer, 4 monitors at 0.5A and one printer at 9A.

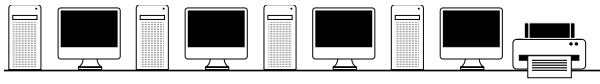

$$2.5A + .5A + 2.5A + .5A + 2.5A + .5A + 2.5A + .5A + 9A = 21A$$

The total number of amperes used in this example equals to 21A.

Divide by 16

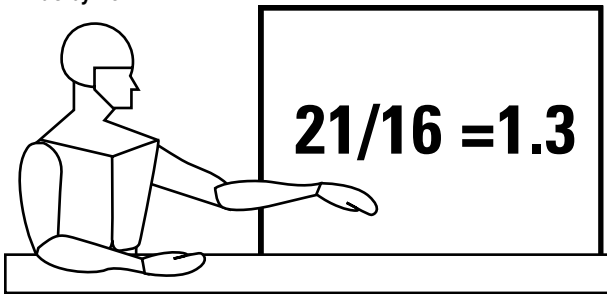

Most machines and computers used in offices or schools are used continuously for many hours at a time. In this type of situation, national electrical codes usually limit circuits at 80% of their capacity of continuous use. Our electrical system is designed for circuits of 20 amps each. So 80% of 20A is 16 Amps. You must therefore divide the total number of amperes calculated by 16.

STEP 3: Determining How Many Circuits You Need

In most cases, this number will contain decimals. Round up to the next whole number, and this will be the number of circuits required for your equipment to run safely. If the number obtained is higher than 4 (the maximum number of circuits for a system), you must reduce the total amperage or add another electrical system. Continuing with our example, the 1.3A is rounded up to 2A.

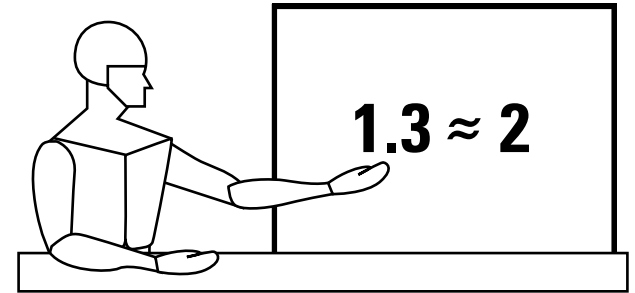

Here is one possible configuration. Using 5 power blocks joined together with junction cables, only 2 circuits are being used. The 4 workstations would be on the first circuit for a total of 16 amps. The printer would be on the second circuit.

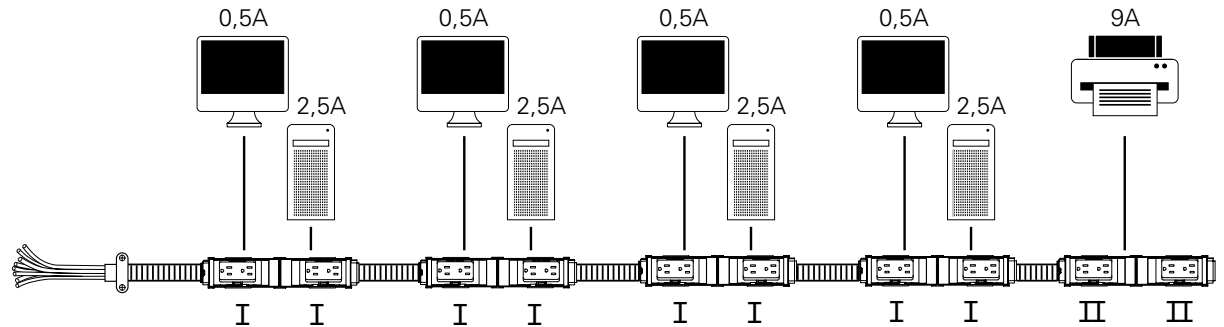

Appendix E: Calculation and Use of Electrical Components

8 Wire, 4 Circuit (3+1) Power Block

- Duplex are interchangeable permitting any required circuit combination;
- Blocks for single or double sided applications;
- Complies with National Electric Code;
- UL Listed/Recognized.

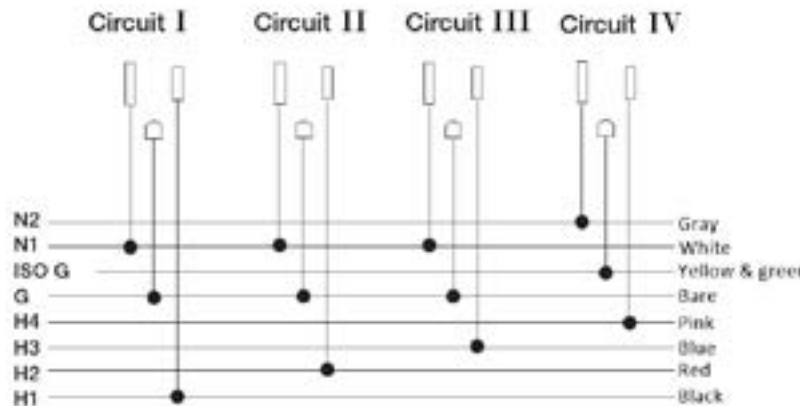
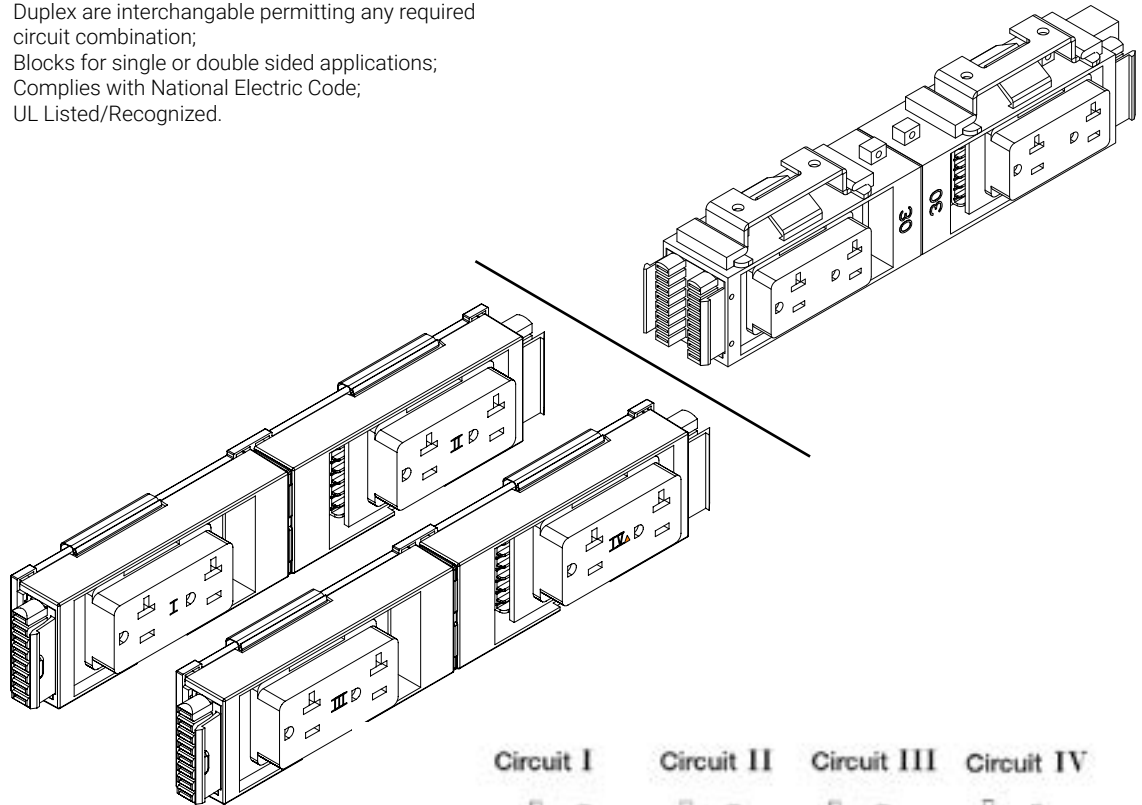

Starter Cable with Hardwire



- 4 circuit starter cable with hardwire at one end;
- 4 circuits rated for 20 AMP each;
- Available in lengths from 12" to 180";
- Whip end to be connected to building power by an electrician.

Starter Cable with Plug



- 1 circuit starter cable with 20A electrical plug;
- Circuit rated for 20 AMP;
- Available in lengths from 36" to 180".

Junction Cable



- 4 circuit cord;
- All circuits rated for 20 AMP;
- Available in lengths from 12" to 216".

Introduction

Appendix F: Locks

E1

[See the E1 lock guide here](#)
[See the instruction videos of the E1 lock](#)

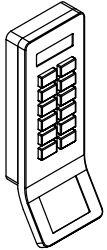

Features:

- Keypad with backlight for easy distinction;
- Wrong code or illegal card alarm;
- Code combination ranging from 1 to 9 digits for multiple possibilities;
- Private and public mode;
- Stainless steel material;
- External power back up.

Lock/Unlock by Master or User Card:

- Scan the master card near the instruction area. The green light comes on with a beep and the lock is unlocked.
- Permanent code mode: scan the card. The red light comes on with 2 beeps and the lock is automatically locked.
- One-time code mode: after unlocking by user card, the lock is in unlocked state.

Power supply	3 x AA alkaline batteries
Card type	EM card (125KHz)
Battery life	12-15 months
Static current	≤20μA
Dynamic current	≤200mA
Working temperature	-15 ℃ +55℃
Working humidity	20 ℃ 95%RH
Alarm voltage	3.7±0.2V
Door thickness	≥ 1mm

Program/Change Master Card:

- After initialization, scan a card near the instruction area.
- After 3 long beeps, the programmed card becomes master card.
- During the flashing period of the LED, the other 2 cards can be programmed up to 3 times max.
- The other 2 cards are needed in the future if one or 2 cards are lost.
- The programming procedure is: * - master card - # new master card.
- After programming a new master, the lost master card is deleted.

Delete Permanent Code:

- Tap the master card on the inductive areas three times. After 3 short beep sounds the permanent code is deleted.

Lock/Unlock by Permanent Code:

- Digital code (max 9 digit) followed by #
- After being unlocked for five seconds, a red light and two beep will sound while the locking automatically.

E2

[See the E2 lock guide here](#)
[See the instruction videos of the E1 lock](#)

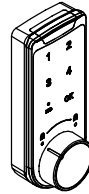

Features:

- Tactile buttons and indicators sound for a premium experience;
- Automatic alarm after 4 attempts;
- 4 digit combination for 10,000 possibilities;
- For shared use (public);
- Low consumption of battery (more than 5,000 uses);
- Easy button cell battery change.

Program your Personal Code:

- Lock: Enter a 4-digit code and turn lock button to lock. Memorize this code. This code will be valid for one use only.
- Unlock: Enter this 4 digit code again and turn lock button to unlock. Do NOT press OK.

Forgotten Code:

- Note the serial number located on the side of the lock.
- Contact Logiflex to obtain the master code for your lock.
- Enter the 8-digit master code and press OK.
- Turn the lock to open.

Master Key Forgotten Code:

- Contact the person in charge of the master key.
- Insert the key and press OK.
- Turn the lock to open.

CMLK

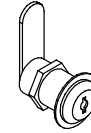

Features:

- Key lock for use in lockers.
- Lock numbers are assigned randomly. Identical keys not available.
- The CMLK lock is different from the standard Logiflex lock. Additional keys and master keys are available on request. Mention that it is the locker lock.
- Finish: Chrome.



Introduction



Appendix G: Electrical Wire Management Solutions

Example : Power Wall PWL

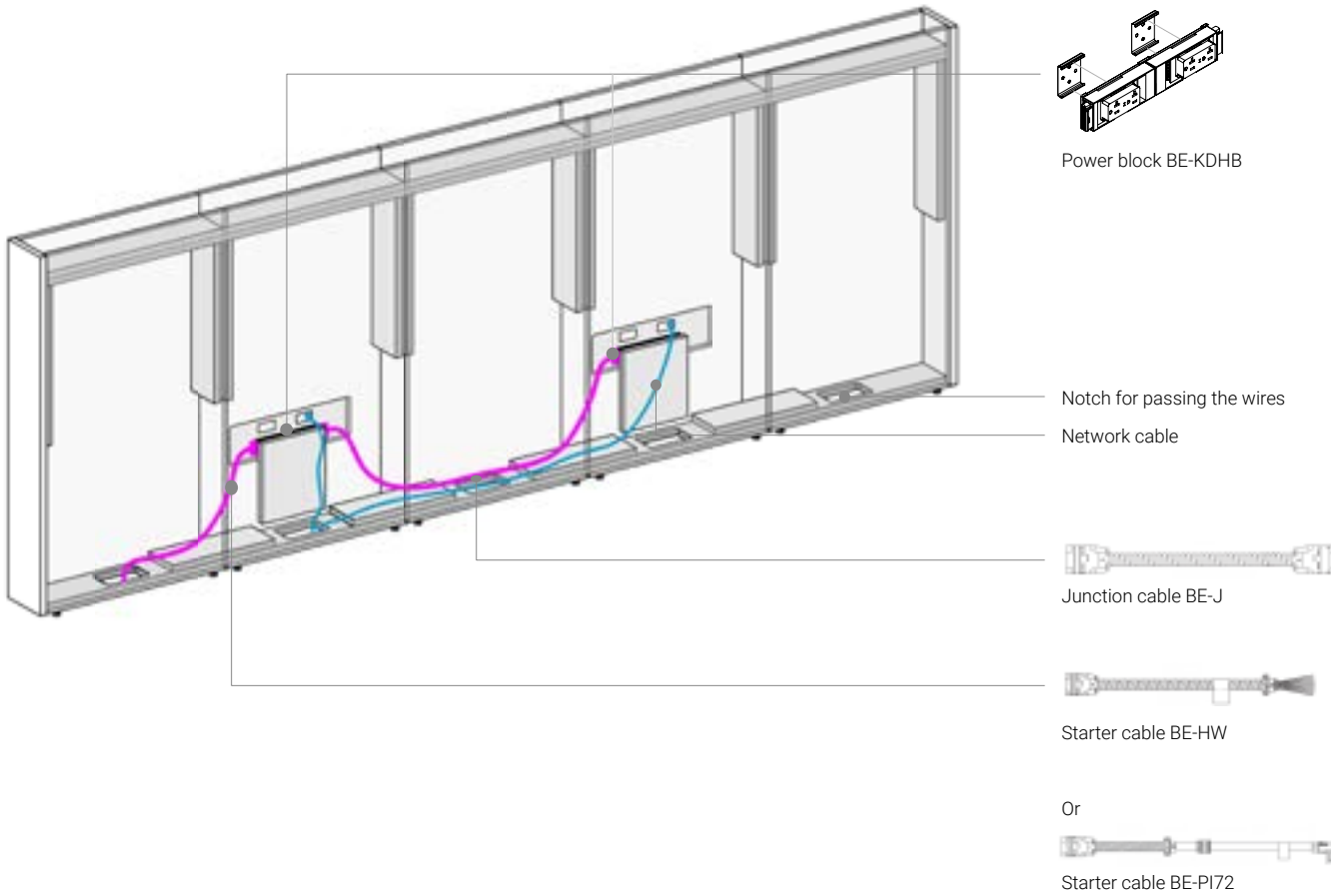

Introduction



Appendix G: Electrical Wire Management Solutions (following)

Example: Option 1.5" Space

Specify this option to allow a 1.5" space between the surface and panel for wiring to run below the surface.

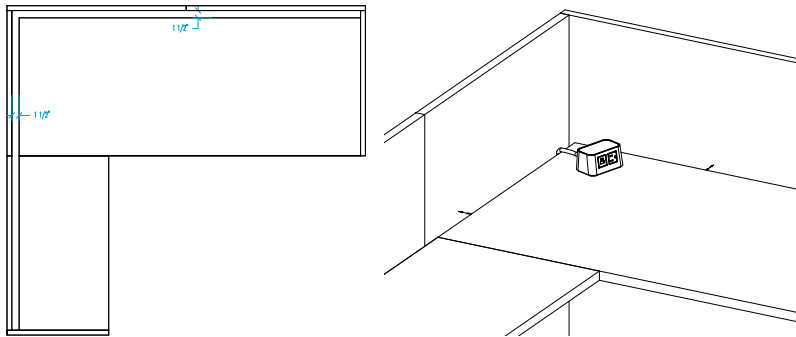

Example: Island Station

The island stations have a removable panel on the side where there is no storage, the removable panels are used to provide access to plugs.

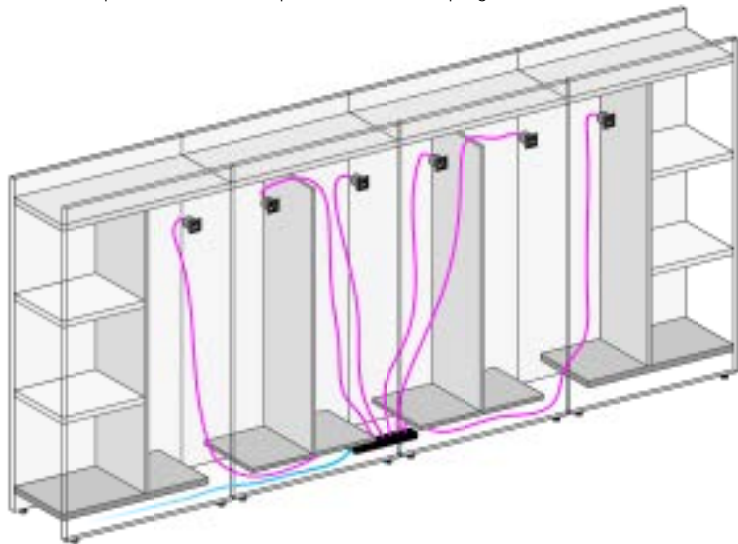

Example: IND Pedestal and High Pedestal

The pedestals have a 2.5' recess to pass wiring.

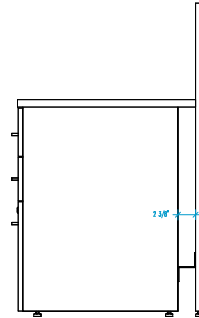

The pedestals have an open back for access to wiring, concealed with a removable panel on the cabinets and BB.

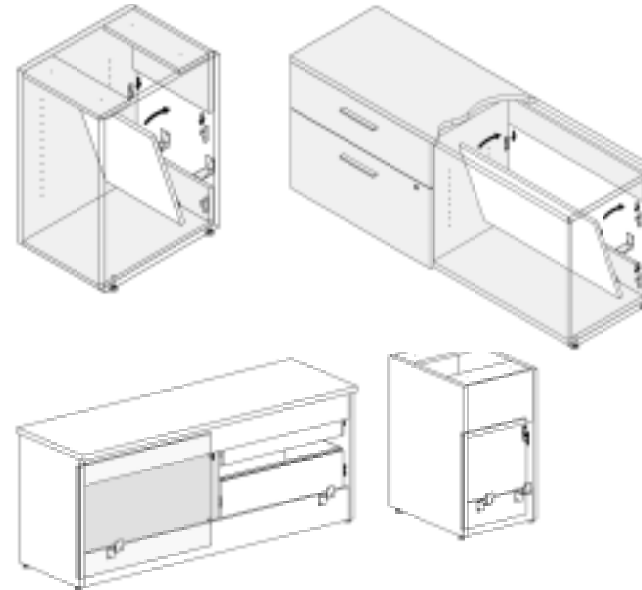

Introduction



Appendix G: Electrical Wire Management Solutions (following)

Example : Storage Tower

Storage towers can be specified with a recessed back by requesting a cutout on the right, left or both sides.

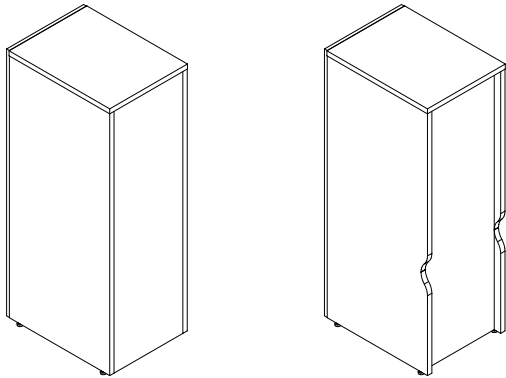

Example : Under the Surface

A metal cable tray can be installed on the dividing panels and power walls. It is recommended to install the cable tray with the help of the supports CNT01/02/03.

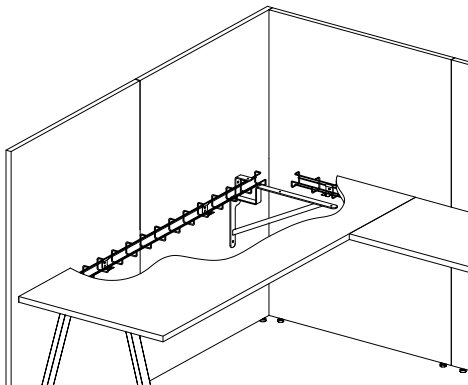

If a cable tray is specified under an Elevation Plus table, it is recommended to specify a CTCOVER to hide the cables.

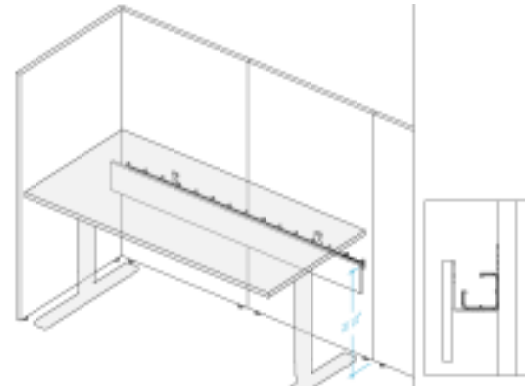

To pass wiring between dividing panels or in power walls, you must order a DSG and drill a 2.5" hole during installation.

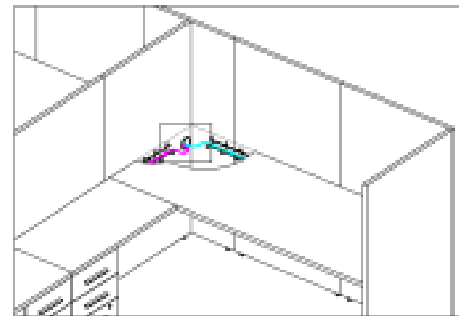
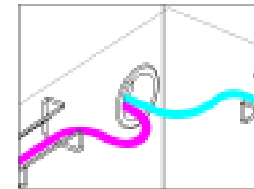



Appendix H: Surface Support

Example : Dividing Panel

The dividing panels are dependent on the furniture inside, here are the rules to follow according to the specification;

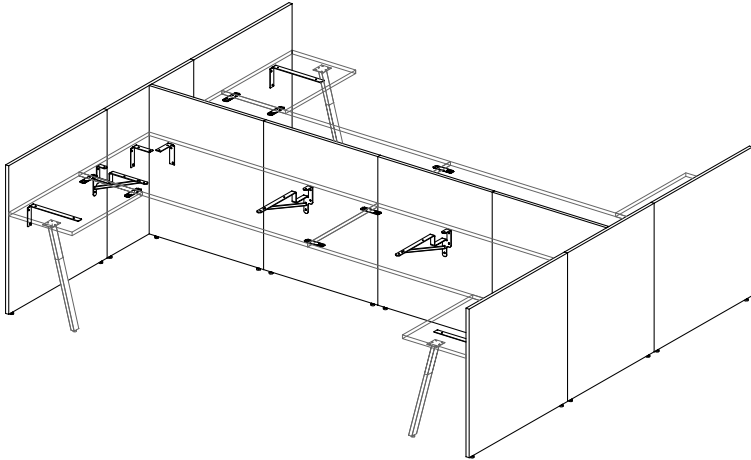

Example : Power Wall

Power walls do not need furniture to be supported, Elevation Plus tables should be used more;

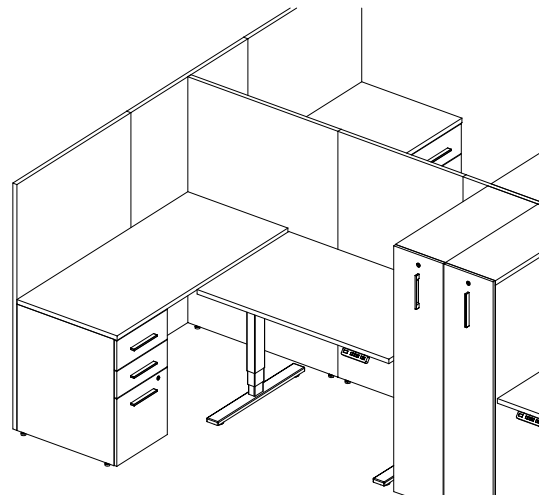
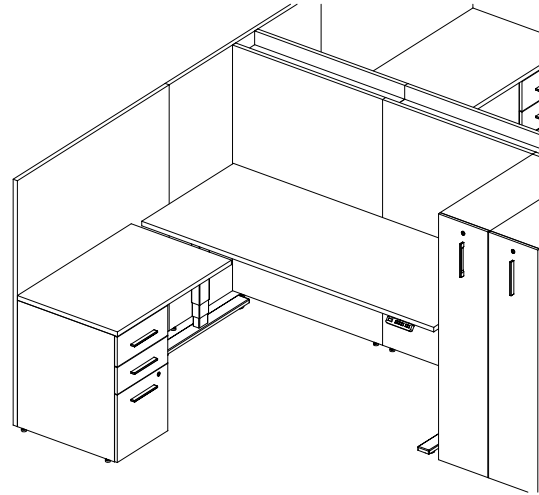

Walls and Panels

Power wall

PWL

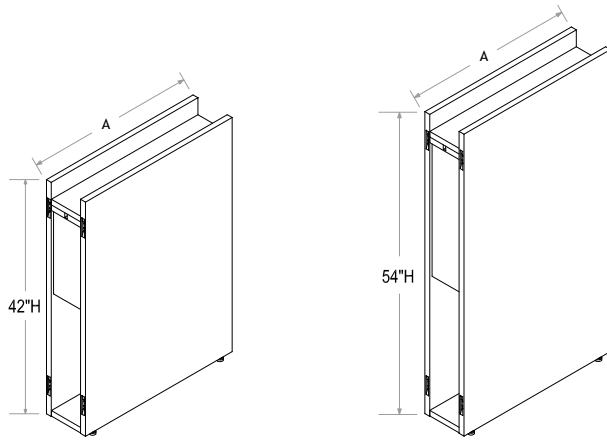

Manufacturing Standards

Power wall with:

- 1" laminate frame with 6" interior space to allow the wiring to pass through;
- Open bottom for wire management;
- Open sides on the left and the right with connectors;
- Connectors compatible with power wall or end panels only;
- White nylon levelers;
- Vertical wood grain.
- Requires end panel when not connected to power wall
- 8" thick

Non freestanding furniture.

Refer to [Appendix H](#) for specification rules.

End panels are needed to close the ends. [See p. 31](#).

Panel accessories sold separately.

Power block option:

Plugs, telecom plate and cables sold separately.

Options

Electric box with access panel

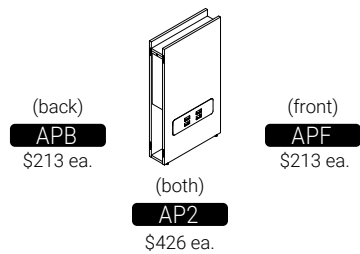

Prices

Dimensions	
A	B
24 42	635
30 42	693
36 42	780
24 54	751
30 54	780
36 54	809

How to Order

Series	Dimensions	Product	Access panel	Metal	
XT	AB	PWL	APF APB AP2 N (std)	SN WH BL (std)	
Example	XT	2442	PWL	N	BL

Walls and Panels

T-shaped Power Wall with dividing panel - 42"H

PWLT - 42"H

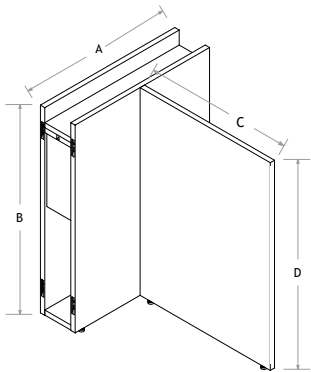

Options

Electric box with access panel

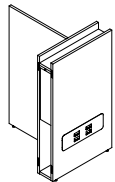

(back)

APB
\$213 ea.

Connector

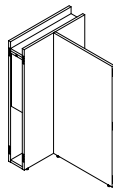

F
\$0

How to Order

XT	AB	PWLT	CD	APB N (std)	SN WH BL (std)	F N (std)
Series	Dimensions low wall	Product	Panel dimensions	Access panel	Metal	Front connector
Example XT	2142	PWLT	2042	N	BL	N

Manufacturing Standards

Power wall with:

- 1" laminate frame with 6" interior space to allow the wiring to pass through;
- Open bottom for wire management;
- Open sides on the left and the right with connectors;
- Connectors compatible with power wall or end panels only;
- White nylon levelers;
- Vertical wood grain.
- Requires end panel when not connected to power wall
- 8" thick

Non freestanding furniture.

Refer to [Appendix H](#) for specification rules.

End panels are needed to close the ends. [See p. 31.](#)

Panel accessories sold separately.

Power block option:

Plugs, telecom plate and cables sold separately.

Power block with finishing panel option not available on sides with division panel and for the *13" and *21" walls.

Prices

Dimensions				
A	B	C	D	
*13	42	12	42	734
*21	42	20	42	792
25	42	24	42	849
31	42	30	42	947
37	42	36	42	1080

Walls and Panels

T-shaped Power Wall with dividing panel - 54"H

PWLT - 54"H

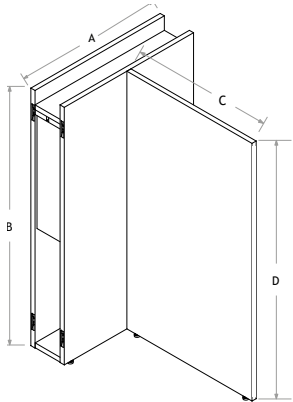

Options

Electric box with access panel

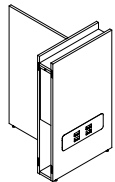

(back)

APB
\$213 ea.

Connector

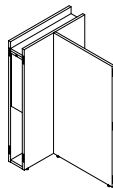

F
\$0

How to Order

XT	AB	PWLT	CD	APB N (std)	SN WH BL (std)	F N (std)
Series	Dimensions low wall	Product	Panel dimensions	Access panel	Metal	Front connector

Example XT 2154 PWLT 2042 N BL N

Manufacturing Standards

Power wall with:

- 1" laminate frame with 6" interior space to allow the wiring to pass through;
- Open bottom for wire management;
- Open sides on the left and the right with connectors;
- Connectors compatible with power wall or end panels only;
- White nylon levelers;
- Vertical wood grain.
- Requires end panel when not connected to power wall
- 8" thick

Non freestanding furniture.

Refer to [Appendix H](#) for specification rules.

End panels are needed to close the ends. [See p. 31.](#)

Panel accessories sold separately.

Power block option:

Plugs, telecom plate and cables sold separately.

Power block with finishing panel option not available on sides with division panel and for the *13" and *21" walls.

Prices

Dimensions				
A	B	C	D	
*13	54	12	42	884
*21	54	20	42	942
25	54	24	42	965
31	54	30	42	1034
37	54	36	42	1109

*13	54	12	54	896
*21	54	20	54	953
25	54	24	54	1011
31	54	30	54	1086
37	54	36	54	1178

Walls and Panels

X-shaped Power Wall with dividing panels - 42"H

PWLX - 42"H

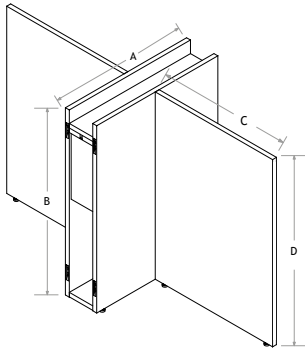

Manufacturing Standards

Power wall with:

- 1" laminate frame with 6" interior space to allow the wiring to pass through;
- Open bottom for wire management;
- Open sides on the left and the right with connectors;
- Connectors compatible with power wall or end panels only;
- 2 simple dividing panels, fixed to the center;
- White nylon levelers;
- Vertical wood grain.
- Requires end panel when not connected to power wall
- 8" thick

Non freestanding furniture.

Refer to [Appendix H](#) for specification rules.

End panels are needed to close the ends. [See p. 31.](#)

Panel accessories sold separately.

Power block with finishing panel option not available on sides with division panel.

Options

Connector

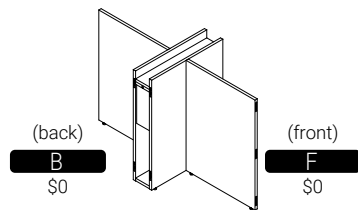

Prices

Dimensions

A B C D

13 42 12 42 866

21 42 20 42 924

25 42 24 42 947

31 42 30 42 1086

37 42 36 42 1265

How to Order

	AB		CD		F N (std)	B N (std)
Series	Dimensions low wall	Product	Panel dimensions	Front connector	Rear connector	
Example	XT	2142	PWLX	2042	N	N

Walls and Panels

X-shaped Power Wall with dividing panel - 54"H

PWLX - 54"H

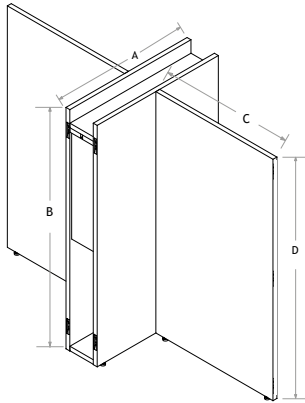

Options

Connector

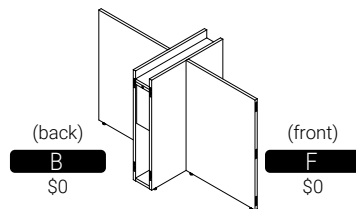

How to Order

	AB		CD		F N (std)	B N (std)
Series	Dimensions low wall	Product	Panel dimensions	Front connector	Rear connector	
Example	XT	2154	PWLX	2042	N	N

Manufacturing Standards

Power wall with:

- 1" laminate frame with 6" interior space to allow the wiring to pass through;
- Open bottom for wire management;
- Open sides on the left and the right with connectors;
- Connectors compatible with power wall or end panels only;
- 2 simple dividing panels, fixed to the center;
- White nylon levelers;
- Vertical wood grain.
- Requires end panel when not connected to power wall
- 8" thick

Non freestanding furniture.

Refer to [Appendix H](#) for specification rules.

End panels are needed to close the ends. [See p. 31.](#)

Panel accessories sold separately.

Power block with finishing panel option not available on sides with division panel.

Prices

Dimensions					
A	B	C	D		
13	54	12	42	982	
21	54	20	42	1040	
25	54	24	42	1063	
31	54	30	42	1173	
37	54	36	42	1294	
<hr/>					
13	54	12	54	1074	
21	54	20	54	1132	
25	54	24	54	1155	
31	54	30	54	1277	
37	54	36	54	1432	

End Panel for Power Wall

EPAN

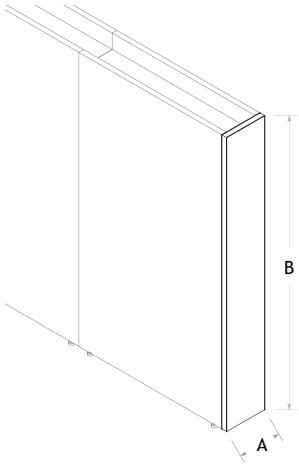

Manufacturing Standards

- End panel:
- 1" laminate panel;
 - With connectors for power wall.

Important: Must be the same height as the power wall

Position of grommet: An ELPF grommet is aligned with the power wall and at 20" H.

To connect division panels on the left or on the right, see products PANL, PANR, PANC.

Options

Grommet



GRC
\$0

How to Order

	AB		GRC NGR (std)
XT		EPAN	
Series	Dimensions	Product	Grommet
Example	XT	0842	EPAN
			N

Prices

Dimensions	
A	B
08 42	81
08 54	87

Walls and Panels

End panel for power wall, extended on one side

EPANL

EPANR

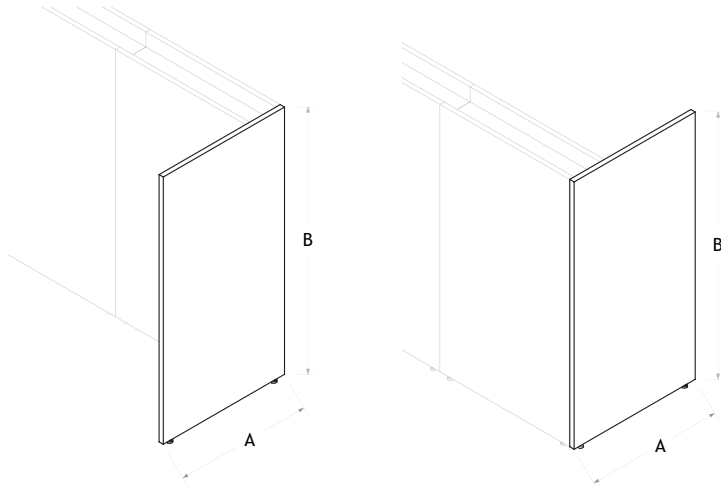

Manufacturing Standards

End panel for power wall, extended on one side:

- 1" laminate panel;
- With connectors for power wall;
- White nylon levelers.

Important: Must be the same height as the power wall.

Connectors: The left panel can only have one connector, on the left. The right panel can only have one connector, on the right.

Position of grommet: An ELPF grommet is aligned with the power wall and at 20" H.

To connect division panels on the left and on the right, see products PANL, PANR, PANC.

Options

Connector

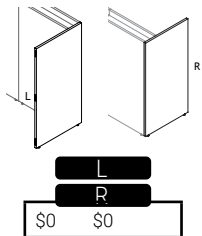

Grommet

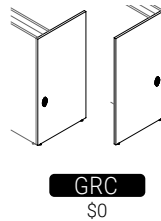

Prices

Dimensions	
A	B
28 42	226
32 42	243
28 54	277
32 54	307

How to Order

XT	AB	EPANL EPANR	L R N (std)	GRC NGR (std)
Series	Dimensions	Product	Connectors	Grommet
Example XT	2842	EPANL	N	NGR

Walls and Panels

End panel for power wall, extended on both sides

EPANC

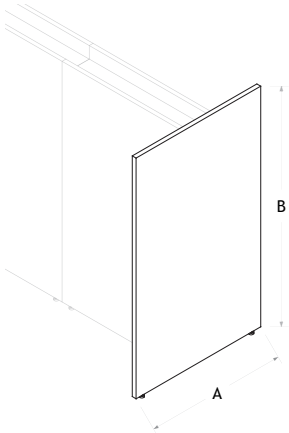

Manufacturing Standards

- End panel for power wall, extended on both sides:
- 1" laminate panel;
 - With connectors for power wall;
 - White nylon levelers.

Important: Must be the same height as the power wall

Position of grommet: An ELPF grommet is aligned with the power wall and at 20" H.

To connect division panels on the left or on the right, see products PANL, PANR, PANC.

Options

Connector

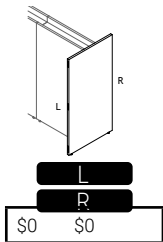

Grommet

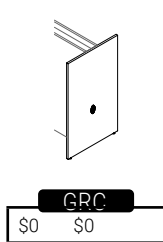

Prices

Dimensions	
A	B
32 42	208
48 42	226
32 54	260
48 54	295

How to Order

Series	Dimensions	Product	Options		
			L N (std)	R N (std)	GRC NGR (std)
			Left connector	Right connector	Grommet
Example XT	3242	EPANC	N	N	N

Walls and Panels

Simple panel

PAN

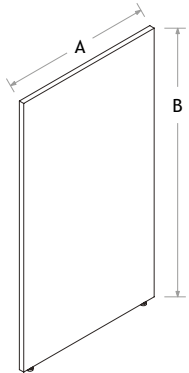

L R

Options

Connector

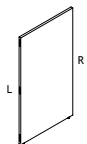

L
R
\$0

How to Order

Series	Dimensions	Product	N	
			L (std)	R (std)
XT	AB	PAN		
			Left connector	Right connector

Example XT 2642 PAN N N

Manufacturing Standards

Simple panel:

- 1" laminate with connectors on each end;
- White nylon levelers.
- Vertical woodgrain.

Non freestanding furniture.

Refer to [Appendix H](#) for specification rules.

Electrical management: refer to [Appendix G](#).

Panel accessories sold separately.

For wire management, holes must be drilled on site by the installer. See [Accessories](#) section for DSG grommet.

Prices

Dimensions	
A	B
06 42	69
12 42	81
14 42	92
15 42	99
18 42	116
20 42	133
24 42	156
26 42	173
30 42	196
32 42	214
36 42	243
42 42	272
48 42	307
<hr/>	
06 54	81
12 54	99
14 54	110
15 54	122
18 54	150
20 54	168
24 54	203
26 54	214
30 54	249
32 54	277
36 54	312
42 54	341
48 54	393

Walls and Panels

L-shaped Panel

PANLL

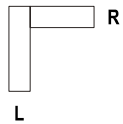
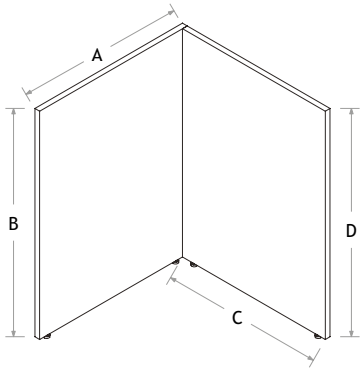

PANLR

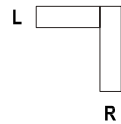
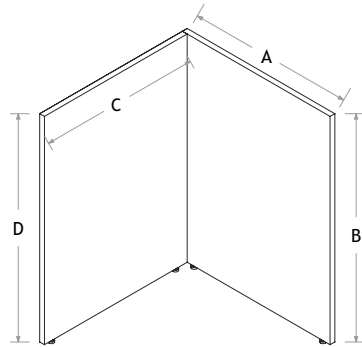

Manufacturing Standards

L-shaped panel:

- Delivered disassembled;
- 1" laminate with connectors on each end;
- White nylon levelers.
- Vertical woodgrain.

Non freestanding furniture.

Refer to [Appendix H](#) for specification rules.

Electrical management: refer to [Appendix G](#).

Panel accessories sold separately.

For wire management, holes must be drilled on site by the installer. See [Accessories](#) section for DSG grommet.

Options

Connector on the left

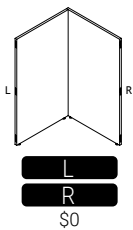

Prices

Dimensions		
A	B C D	
07 42 06 42	144	
21 42 20 42	266	
25 42 24 42	312	
31 42 30 42	393	
37 42 36 42	485	
<hr/>		
07 54 06 42	167	
21 54 20 42	300	
25 54 24 42	358	
31 54 30 42	444	
37 54 36 42	554	
<hr/>		
07 54 06 54	185	
21 54 20 54	335	
25 54 24 54	404	
31 54 30 54	497	
37 54 36 54	624	

How to Order

XT	AB	PANLR PANLL	CD	N L (std)	N R (std)
Series	Dimensions 1st panel	Product	Dimensions 2nd panel	Left connector	Right connector
Example XT	2142	PANLR	2042	N	N

Walls and Panels

T-Shaped Panel

PANT

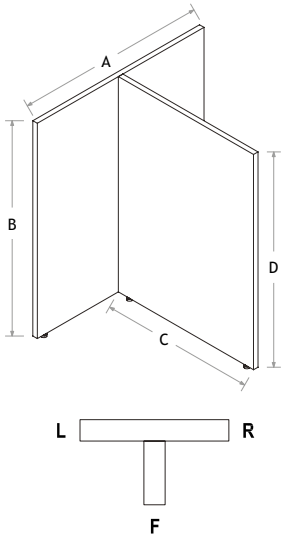

Manufacturing Standards

T-shaped panel:

- Delivered disassembled;
- 1" laminate with the possibility to connect on each end;
- White nylon levelers.
- Vertical woodgrain.

Non freestanding furniture.

Refer to [Appendix H](#) for specification rules.

Electrical management: refer to [Appendix G](#).

Panel accessories sold separately.

For wire management, holes must be drilled on site by the installer. See [Accessories](#) section for DSG grommet.

Options

Connector

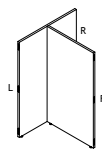

- L** \$0
- F** \$0
- R** \$0

Prices

Dimensions				
A	B	C	D	
13	42	06	42	144
13	42	12	42	156
21	42	20	42	272
25	42	24	42	307
31	42	30	42	393
37	42	36	42	485
41	42	40	42	543
13	54	06	42	167
13	54	12	42	185
21	54	20	42	307
25	54	24	42	347
31	54	30	42	444
37	54	36	42	554
41	54	40	42	612
13	54	06	54	185
13	54	12	54	203
21	54	20	54	341
25	54	24	54	393
31	54	30	54	497
37	54	36	54	624
41	54	40	54	681

How to Order

XT	AB	PANT	CD	N L (std)	N R (std)	N F (std)	
Series	Dimensions	Product	Height	Left connector	Right connector	Front connector	
Example	XT	1342	PANT	1242	N	N	N

Walls and Panels

X-shaped Panel

PANX

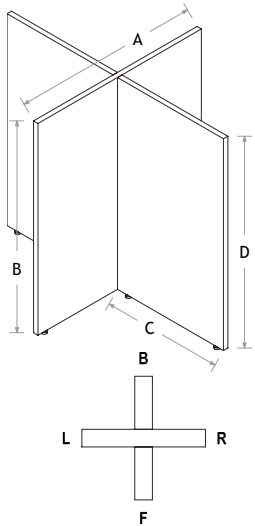

Manufacturing Standards

X-shaped panel:

- Delivered disassembled;
- 1" with the possibility to connect on each end;
- White nylon levelers;
- Vertical woodgrain.

Non freestanding furniture.

Refer to [Appendix H](#) for specification rules.

Electrical management: refer to [Appendix G](#).

Panel accessories sold separately.

For wire management, holes must be drilled on site by the installer. See [Accessories](#) section for DSG grommet.

Options

Connector on the left

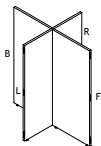

- L
\$0
- F
\$0
- R
\$0
- B
\$0

Prices

Dimensions			
A	B	C D	
13	42	06 42	225
13	42	12 42	243
21	42	20 42	404
25	42	24 42	462
31	42	30 42	589
37	42	36 42	728
41	42	40 42	815
13	54	06 42	258
13	54	12 42	276
21	54	20 42	434
25	54	24 42	515
31	54	30 42	641
37	54	36 42	797
41	54	40 42	884
13	54	06 54	294
13	54	12 54	312
21	54	20 54	503
25	54	24 54	607
31	54	30 54	746
37	54	36 54	936
41	54	40 54	1023

How to Order

XT	AB	PANX	CD	N L (std)	N R (std)	N F (std)	N B (std)
Series	Dimensions	Product	Height 2nd panel	Left connector	Right connector	Front connector	Rear connector
Example	XT	1342	PANX	1242	N	N	N

Panel Accessories

Hanging tackboard

TBP

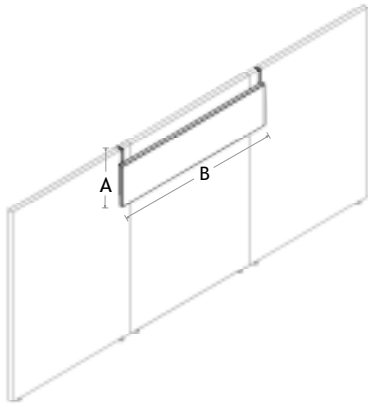

Manufacturing Standards

Hanging tackboard :

- 7/8" tackboard, 1/8" tick clip, ~1" thick total;
- Hanging on panels or on power walls;
- 2 hooks in the finish of your choice included.

The height of the panels is 3" less than the overall height.

We do not recommend the use of tackboards with height adjustable tables unless there is adequate clearance.

Prices

Dimensions		COM												
A	B	GRA	GR1	GR2	GR3	GR4	GR5	GR6	GR7	GR8	GR9	GR10	GR11	GR12
12	24	255	280	313	346	387	429	470	511	552	594	635	717	800
12	30	255	280	313	346	387	429	470	511	552	594	635	717	800
12	36	255	280	313	346	387	429	470	511	552	594	635	717	800
12	42	255	280	313	346	387	429	470	511	552	594	635	717	800
12	48	255	280	313	346	387	429	470	511	552	594	635	717	800
12	54	255	280	313	346	387	429	470	511	552	594	635	717	800
12	60	344	377	421	465	520	575	630	685	740	795	850	960	1070
12	66	344	377	421	465	520	575	630	685	740	795	850	960	1070
12	72	385	426	481	536	605	674	742	811	880	949	1017	1155	1292
18	24	279	304	337	370	411	453	494	535	576	618	659	741	824
18	30	279	304	337	370	411	453	494	535	576	618	659	741	824
18	36	279	304	337	370	411	453	494	535	576	618	659	741	824
18	42	279	304	337	370	411	453	494	535	576	618	659	741	824
18	48	279	304	337	370	411	453	494	535	576	618	659	741	824
18	54	279	304	337	370	411	453	494	535	576	618	659	741	824
18	60	369	402	446	490	545	600	655	710	765	820	875	985	1095
18	66	369	402	446	490	545	600	655	710	765	820	875	985	1095
18	72	410	451	506	561	630	699	767	836	905	974	1042	1180	1317
24	24	304	329	362	395	436	478	519	560	601	643	684	766	849
24	30	304	329	362	395	436	478	519	560	601	643	684	766	849
24	36	304	329	362	395	436	478	519	560	601	643	684	766	849
24	42	304	329	362	395	436	478	519	560	601	643	684	766	849
24	48	304	329	362	395	436	478	519	560	601	643	684	766	849

How to Order

	AB	TBP	SN WH BL (std)
XT			
Series	Dimensions	Product	Metal finish

Example XT 1824 TBP BL

Markerboard

MBP

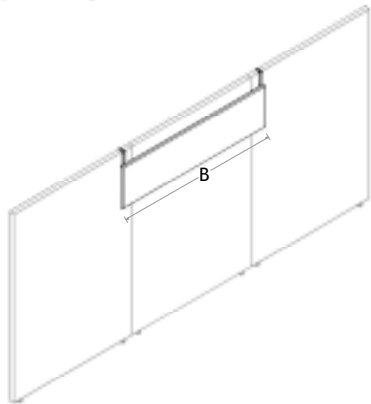

Manufacturing Standards

Markerboard:

- 5/8" board, 1/8" tick clip, ~3/4" thick total;
- To install on panels or on power walls;
- 2 hooks in the finish of your choice included.

The height of the tackboard is 3" less than the overall height.

We do not recommend the use of tackboards with height adjustable tables unless there is adequate clearance.

Prices

Dimensions

A	B	C
12	24	104
12	30	116
12	36	127
12	42	139
12	48	150
12	54	162
12	60	173
12	66	185
12	72	196

18	24	127
18	30	145
18	36	162
18	42	180
18	48	196
18	54	214
18	60	231
18	66	249
18	72	266

24	24	150
24	30	173
24	36	196
24	42	219
24	48	243

How to Order

Series	Dimensions	Product	Metal finish
XT	AB	MBP	SN WH BL (std)

Example

XT	1824	MBP	BL
----	------	-----	----

Panel Accessories

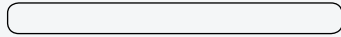

Transaction Shelf

SHP

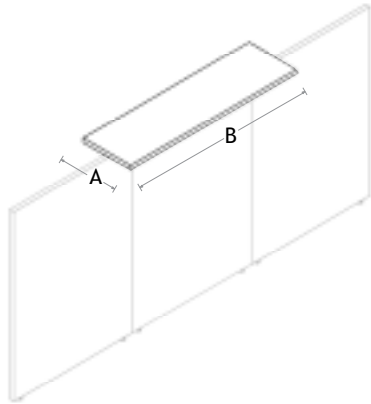

Manufacturing Standards

- Transaction shelf with:
- 1" laminate;
 - 2 "L" brackets included;
 - To install on dividing panels or power walls;
 - 2 brackets when less than 42", 3 brackets when 42" and more.

Prices

Dimensions		
A	B	C
12 24		92
12 30		99
12 36		104
12 42		110
12 48		116
12 54		127
12 60		139
12 66		150
12 72		162

How to Order

AB		
XT		SHP
Series	Dimensions	Product

Example **XT** 1224 **SHP**

Panel Accessories

Metal Planter Box

LPLANTS

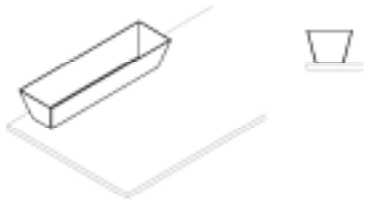

LPLANTP

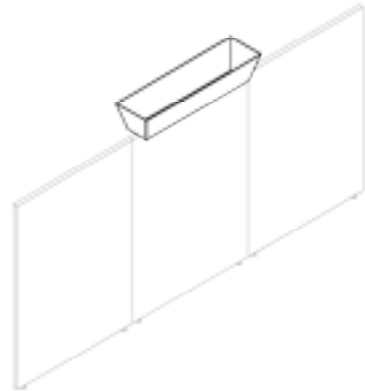

Dividing panel



Power wall

Manufacturing Standards

Metal Planter Box:

- Dimensions: 8 x 30 x 6 H
- LPLANTS: Set-on surface
- LPLANTP: Rests on dividing panel

Prices

Code	
LPLANTS	376
LPLANTP	404

How to Order

LPLANTS	SN
LPLANTP	WH
	BL (std)
<input type="text"/>	<input type="text"/>
Product	Metal finish

Example LPLANTP BL

Panel Accessories



Acrylic divider on panel

EAS

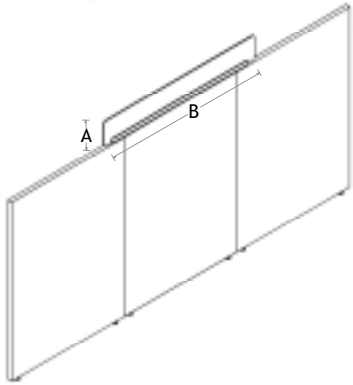

Manufacturing Standards

- Acrylic divider on panel:
- Acrylic panel with metal finish of your choice extrusion;
 - Fixed on edge.

Dimension "B" allows the installation of panel accessories in combination with the divider.

Metal extrusion is 4" shorter than acrylic panel

Prices

Dimensions	
A	B
06 22	156
06 28	185
06 34	214
06 40	237
06 46	260
06 52	277
06 58	284
06 64	289
06 70	295

How to Order

	AB		SN WH BL (std)
XT		EAS	
Series	Dimensions	Product	Metal finish

Example XT 0622 EAS BL

Panel Accessories



Hexagonal felt tile

ATF01

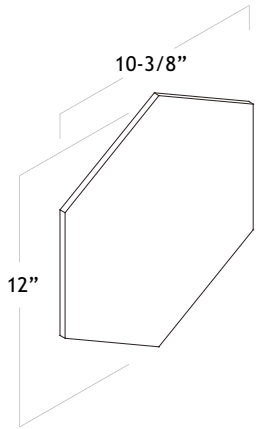

Manufacturing Standards

Hexagonal felt tile:

- Accoustical adhesive felt tile 10-3/8" x 12".

Important: Item is too thin to be used as tackboard.

Felt colors: Blue **BL**, Light Grey **LG**, Dark Grey **DG**.

Prices

Code	
ATF01 LG	58
ATF01 DG	58
ATF01 BL	58

How to Order

ATF01	BL LG DG
Product	Felt color

Example ATF01 BL

Panel Accessories

Stabilizing Laminate Corner

MTC

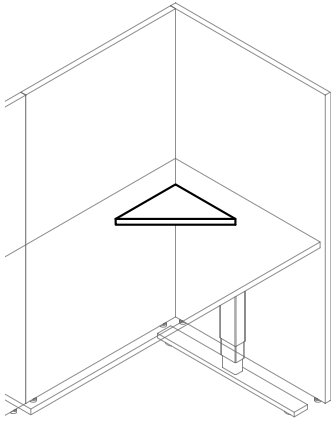

Manufacturing Standards

Laminate triangle corner with:

- 1" laminate panel;
- Mounting hardware;
- Made for situations where no items are panel mounted;
- Maximum load: 25lbs.

Prices

Dimensions

A	B
12	12
	53

How to Order

XT	12 12	MTC
Series	Dimensions	Product

Example XT 1212 MTC

Sound absorbing overhead screen - 1-sided

OHSS

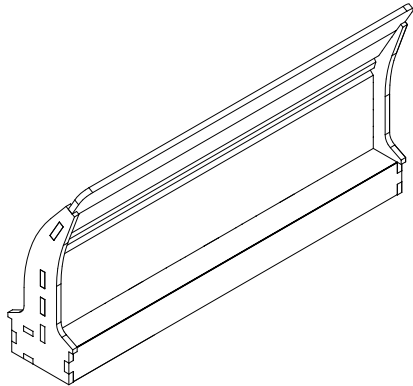

Manufacturing Standards

Sound absorbing overhead screen - 1 sided:

- Total height of 18", exceeds 15" from the wall;
- 100% PET (min, 50% recycled content);
- 12 mm material;
- 15 finishes available;
- No hardware assembly;
- Fully tackable surface;
- Sound absorption characteristics:
NRC: 0.80
SAA: 0.80
ASTM C423

Ezobord Colors: Bold Gray **BG07**, Green Moss **MG10**.

For more colors, see [Appendix A](#). Note that you must order 6 or more to access the other colors.

Prices

Dimensions	
A	
30	924
36	924

How to Order

OHSS		
Product	Dimensions	Finishes see appendix A

Example OHSS 30 BG07

Sound absorbing overhead screen - 2-sided

OHSD

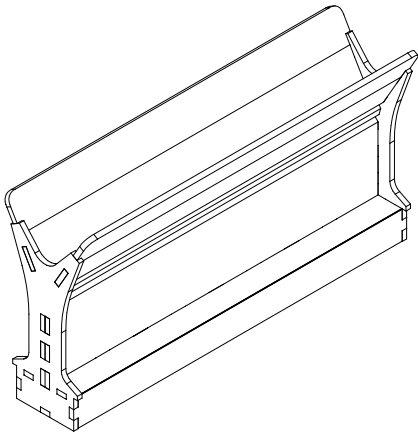

Manufacturing Standards

Sound absorbing overhead screen - 2 sided:

- Total height of 18", exceeds 15" from the wall;
- 100% PET (min, 50% recycled content);
- 12 mm material;
- 15 finishes available;
- No hardware assembly;
- Fully tackable surface;
- Sound absorption characteristics:
NRC: 0.80
SAA: 0.80
ASTM C423

Ezobord Colors: Bold Gray **BG07**, Green Moss **MG10**.

For more colors, see [Appendix A](#). Note that you must order 6 or more to access the other colors.

Prices

Dimensions	
A	
30	1097
36	1097

How to Order

OHSD		
Product	Dimensions	Finishes see appendix A

Example OHSD 30 BG07

Panel Accessories

Laminate Cover

CTCOVER

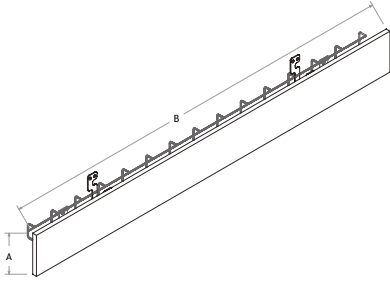

Manufacturing Standards

Laminate cover:

- Laminate cover for cable tray;
- Mounting brackets;
- Dimension "B" is 1/4" recessed.

Prices

Dimensions	
A	B
06 30	46
06 36	53
06 42	58
06 48	64
06 54	69
06 60	76
06 66	81
06 72	87
06 78	92
06 84	99

How to Order

	AB	CTCOVER
XT		
Series	Dimensions	

Example XT 0630 CTCOVER

Surfaces

Rectangular surface 15" & 20"D

TOP

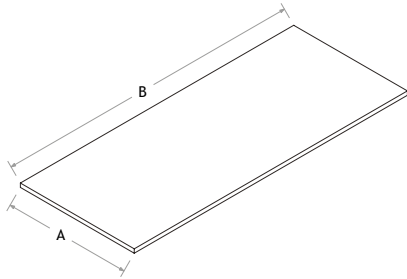

Options

1½" space for wiring

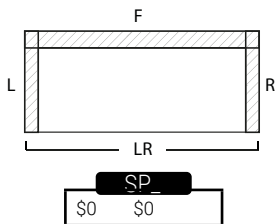

How to Order

XT	AB	TOP	SP3 SPL SPLR SPR SPFR SPF SPFL SPN (std)
Series	Dimensions	Product	Space 1½" for wiring

Example XT 1524 TOP SPN

Manufacturing Standards

Rectangular surface:

- 1" laminate surface;
- Hardware sold separately;
- Wiring space is removed from the overall dimension.

No machining.

Support: Legs, cantilever and independent storage are sold separately.

Maximum distance between two supports: 42".

Stiffener: The use of stiffeners is necessary for surfaces of 54" and more. It is used for the part of the surface not supported by a pedestal.

Prices

Dimensions	
A	B
15 24	84
15 30	84
15 36	84
15 42	96
15 48	110
15 54	124
15 60	138
15 66	151
15 72	165
15 78	177
15 84	192

20 16	84
20 24	84
20 30	91
20 36	110
20 42	128
20 48	147
20 54	165
20 60	183
20 66	201
20 72	219
20 78	238
20 84	256

Surfaces

Rectangular surface 24", 30" & 36"D (following)

TOP

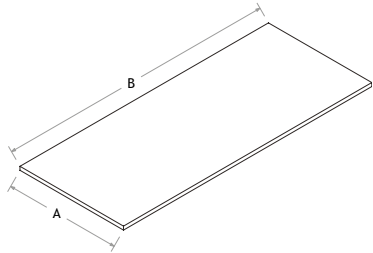

Options

1½" space for wiring

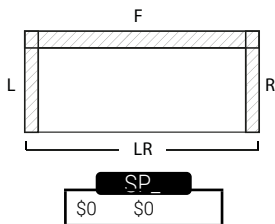

How to Order

XT	AB	TOP	SP3 SPL SPLR SPR SPFR SPF SPFL SPN (std)
Series	Dimensions	Product	Space 1½" for wiring

Example XT 2430 TOP SPN

Manufacturing Standards

Rectangular surface:

- 1" laminate surface;
- Hardware sold separately;
- Wiring space is removed from the overall dimension.

No machining.

Support: Legs, cantilever and independent storage are sold separately.

Maximum distance between two supports: 42".

Stiffener: The use of stiffeners is necessary for surfaces of 54" and more. It is used for the part of the surface not supported by a pedestal.

Prices

Dimensions	
A	B
24 30	110
24 36	131
24 42	153
24 48	175
24 54	197
24 60	219
24 66	242
24 72	264
24 78	286
24 84	308
30 54	247
30 60	275
30 66	301
30 72	330
30 78	357
30 84	384
36 54	312
36 60	347
36 66	381
36 72	416
36 78	450
36 84	485

Surfaces



D surface

DTOP

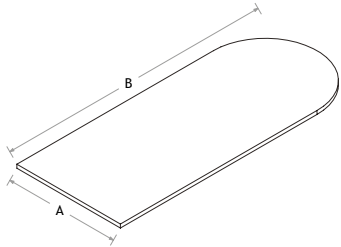

Manufacturing Standards

- D surface:
- 1" laminate;
 - Hardware sold separately: See the support and modesty section. An independent pedestal can also be used;
 - Wiring space is removed from the overall dimension.

No machining.

Support: Legs, cantilever and independent storage are sold separately.

Maximum distance between two supports: 42".

Stiffener: The use of stiffeners is necessary for surfaces of 54" and more. It is used for the part of the surface not supported by a pedestal.

Options

1½" space for wiring

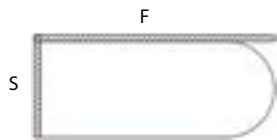

Prices

Dimensions	
A	B
24	54
24	60
24	66
24	72
24	78
24	84
<hr/>	
30	54
30	60
30	66
30	72
30	78
30	84
<hr/>	
36	54
36	60
36	66
36	72
36	78
36	84

How to Order

XT	AB	DTOP	SPF SPS SPFS SPN (std)	
Series	Dimensions	Product	Space 1½" for wiring	
Example	XT	2454	DTOP	SPN

Surfaces

Collaboration surface

COLTOP

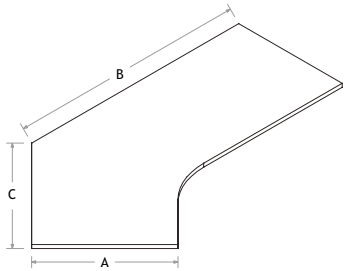

CORTOP

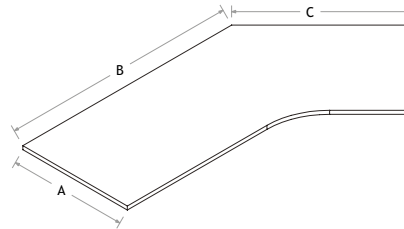

Manufacturing Standards

Collaboration surface:

- 1" laminate;
- Angle: 135
- Hardware sold separately;
- Wiring space is removed from the overall dimension.

Overall dimensions :

- 30 54 30 : 43"D x 75-3/4"W
- 30 60 36 : 47-1/4"D x 86"W
- 30 66 36 : 47-1/4"D x 92"W

No machining.

Support: Legs, cantilever and independent storage are sold separately.

Maximum distance between two supports: 42".

Stiffener: The use of stiffeners is necessary for surfaces of 54" and more. It is used for the part of the surface not supported by a pedestal.

Options

1½" space for wiring

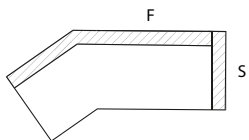

SP_ \$0

Prices

Dimensions		
A	B	C
30 54 30		603
30 60 36		761
30 66 36		815

How to Order

XT	ABC	COLTOP CORTOP	SPF SPS SPFS SPN (std)
Series	Dimensions	Product	Space 1½" for wiring

Example XT 305430 COLTOP SPN



Privacy corner screen

FSFD

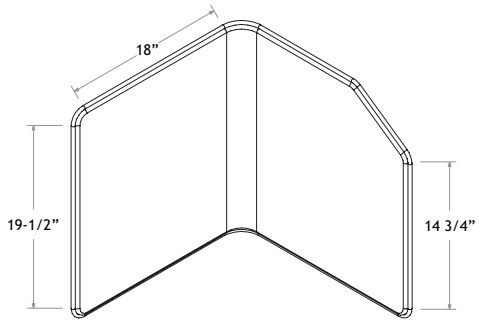

Manufacturing Standards

- Privacy Corner Screen
- 7/8" thick plywood panel, upholstered;
 - With decorative piping;
 - Set-on surface;
 - Panel / tackboard fabrics not recommended;
 - Dimensions: 18" x 19-1/2".

Cannot be used as a tackboard

Prices

	GRA	GR1	COM GR2	GR3	GR4	GR5	GR6	GR7	GR8	GR9	GR10	GR11	GR12
FSFD	410	435	468	501	542	584	625	666	707	749	790	872	955

How to Order

FSFD

Product Fabrics
 see appendix A

Example FSFD TBFRME

Supports

End leg

ENDLEG

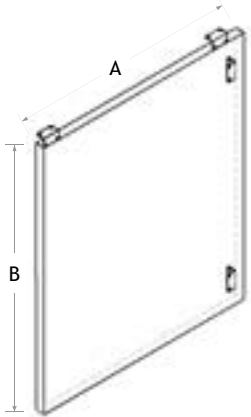

Manufacturing Standards

- End Leg:
- 1" Laminate;
 - 4 mounting brackets;
 - White nylon levelers;
 - Height: 28"H.

Prices

Dimensions		
A	B	
20	28	116
24	28	127
30	28	139
36	28	150

How to Order

AB		
XT		ENDLEG
Series	Dimensions	Product

Example XT 2028 ENDLEG

Supports

Middle leg

MIDLEG

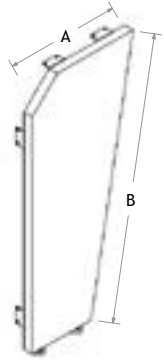

Manufacturing Standards

- Middle leg:
- 1" laminate with space for wiring;
 - 4 mounting brackets;
 - White nylon levelers;
 - Height: 28"H.

Prices

Dimensions

A	B
12 28	150

How to Order

	AB	
XT		MIDLEG
Series	Dimensions	Product

Example XT 1228 MIDLEG

Supports

Legs

RAW

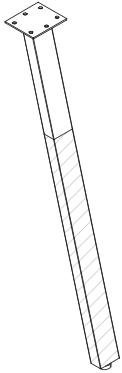

RA2

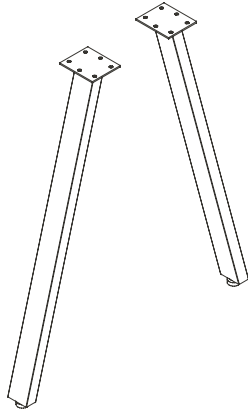

HATLEY



Manufacturing Standards

RAW:

- Base in metal, finish: Satin Nickel (SN), White (WH) and Black (BL);
- Wood insert (18");
- White nylon levelers;
- Height: 28".

RA2:

- Set of 2 angled rectangular metal legs;
- Dimensions: 2" x 1";
- Finish: Satin Nickel (SN) and Black (BL);
- Height: 28".

HATLEY:

- Set of two 28" tapered legs with wood insert;
- 4" x 4" end plate;
- Finish: Satin Nickel (SN), Chrome (CHR) and Black (BL);
- Height: 28".

For stability reasons, please check with your account manager the dimensions of your furniture when ordering this leg separately from the surface.

Available colors for wood (RAW & HATLEY): White Wash WW, Golden Wheat GW, Sand SD, Apricot AT, Pecan PN, Brandy BR, Chestnut CT, Coffee CF, Espresso ES, Bordeaux BO, Black Wash BW and Bark BK

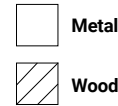

Prices

Code	
RAWBL	177
RAWSN	177
RAWWH	177
Code	
RA2SN	188
RA2BL	188
RA2WH	188
Code	
HATSN	311
HATCHR	311
HATBL	311

How to Order

			Finishes See the Logiflex Color Guide		
Product	Metal	wood color	Product	Metal	wood color
RAW	WH SN BL (std)		RA2	WH SN BL	
Example	RAW	BL	Example	RA2	BL
		GW	Example	HAT	BL
					GW

Supports

Legs

4.5

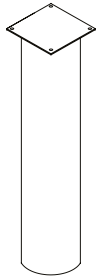

IFN

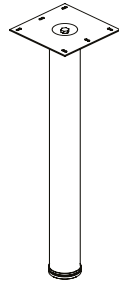

Manufacturing Standards

4.5:

- Fixed round metal leg / on leveler;
- 4-1/2" diameter;
- 6" x 6" end plate;
- Finish: Black (BL) and Satin Nickel (SN);
- Height: 27-1/2".

IFN:

- Fixed round metal leg / on leveler;
- 2-1/2" diameter;
- 3-3/4" x 3-3/4" end plate screwed to the leg;
- Finish: Black (BL) and Satin Nickel (SN);
- Height: 27-1/2".

Prices

Code

4.5BL 240

4.5SN 240

Code

IFNBL 84

IFNSN 84

How to Order

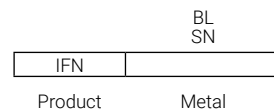
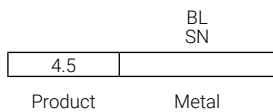

Example 4.5 BL

Example IFN BL

Supports

Legs

LENNOX

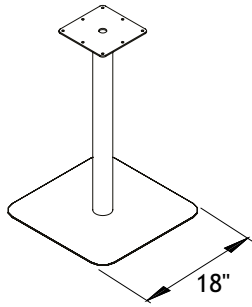

MAGOG

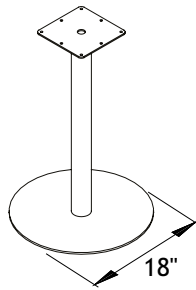

Manufacturing Standards

LENNOX:

- Fixed Lennox leg;
- Base: 18";
- 8" x 8" end plate;
- Finish: Satin Nickel (SN), Black (BL) and Chrome (CHR);
- Height: 28".

MAGOG:

- Fixed Magog leg;
- Base: 18";
- 8" x 8" end plate;
- Finish: Satin Nickel (SN), Black (BL) and Chrome (CHR);
- Height: 28".

For stability reasons, please check with your account manager the dimensions of your furniture when ordering this leg separately from the surface.

Prices

Code	
LENSN	495
LENBL	495
LENCHR	1010
LENWH	495

Code	
MAGSN	495
MAGBL	495
MAGCHR	1010
MAGWH	495

How to Order

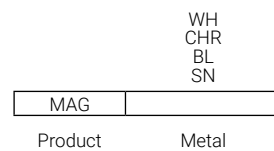
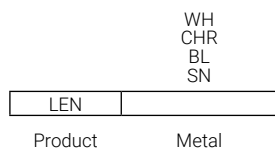

Example LEN BL

Example MAG BL

Supports

Legs

PATTEC30

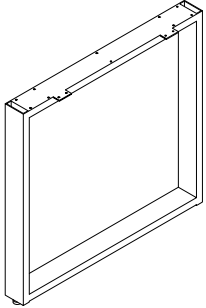

PATTEC36

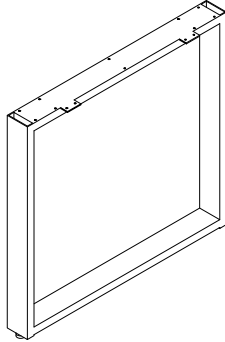

Manufacturing Standards

C Metal Leg:

- Base in metal, Black (BL);
- White nylon levelers;
- Height: 28"H;
- 1 1/2" space for wiring with top is not compatible.

Prices

Code	
PATTEC30	270
PATTEC36	310

How to Order

PATTEC30	WH
PATTEC36	SN
	BL (std)
<input type="text"/>	<input type="text"/>
Product	Metal

Example PATTEC30 BL

Supports

Layering Desk Supports

DRSUP

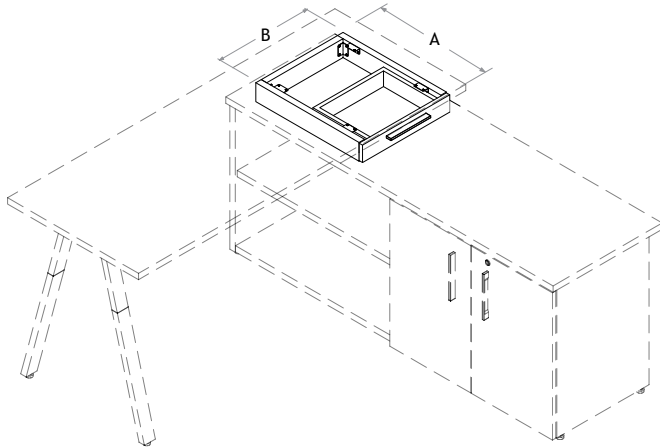

Manufacturing Standards

Layering desk:

- Drawer and front 5/8" laminate;
- Frame 1" laminate;
- Mounting brackets, screws and double-sided tape included;
- Height: 3"H.
- Interior dimensions of the drawer:
11-11/16" width x 9-3/8" depth x 2-1/2" height.

Support for high cabinets: This product is used to support the surface on a high cabinet 25"H.

Color Combination

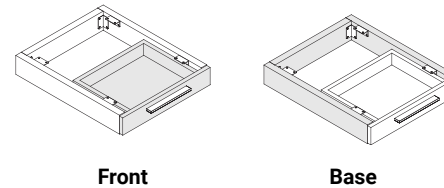

Front

Base

Prices

Dimensions	
A	B
14 16	204
20 16	204
26 16	204

How to Order

	AB	H071BL (std)	
Series	Dimensions	Product	Handle
Example XT	1416	DRSUP	H071BL

Supports



T-Support

TSUP

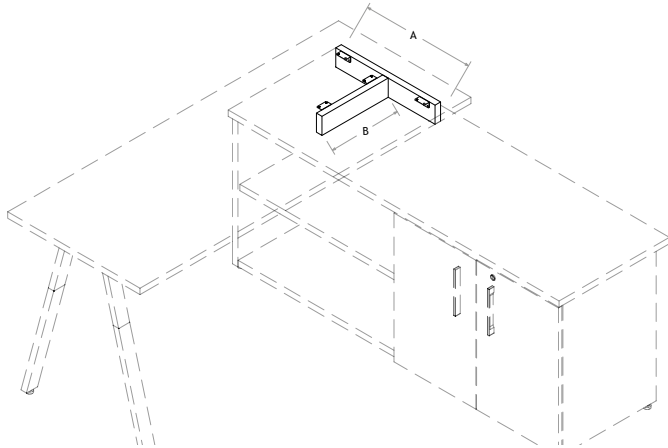

Manufacturing Standards

T-Support:

- 1" laminate;
- Mounting brackets, screws and double-sided tape included;
- Height: 3"H;
- Dimensions recommendations:
 - A 18 B 12 for 24" surface
 - A 26 B 12 for 30" surface
 - A 32 B 12 for 36" surface

Support for high cabinets: This product is used to support the surface on a high cabinet 25"H.

Prices

Dimensions	
A	B
18 12	84
26 12	84
32 12	84

How to Order

AB		
XT		TSUP
Series	Dimensions	Product

Example

XT	1812	TSUP
----	------	------

Supports

Cantilever support with space for cable tray

CNT01

CNT02

CNT03

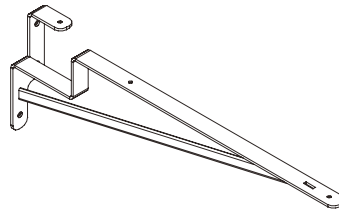
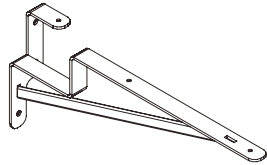
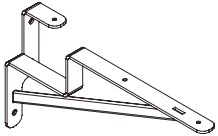

Manufacturing Standards

Cantilever support with space for cable tray:

- Metal support, Satin Nickel finish;
- Without pointing for assembly;
- Height: 8"H.

Dimensions :

CNT01 : 16.5", for 20"D surface

CNT02 : 20.5", for 24"D and 30"D surface

CNT03 : 27", for 36"D surface

To help installation, order IGS.

Work surface support.

Refer to [Appendix H](#) for specification rules.

Compatible with CT24 and CT118 cable tray.

Prices

Code	
CNT01	50
CNT02	56
CNT03	64

How to Order

CNT01
CNT02
CNT03

	SN
--	----

Product Metal

Example CNT01 SN

Supports

Slender cantilever support

CNTC01

CNTC02

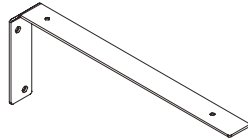
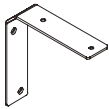

Manufacturing Standards

Cantilever support without reinforcement bar:

- Metal support;
- Without pointing for assembly;
- Height: 6"H.

Dimensions :

CNTC01 : 6", for surfaces less than 30"

CNTC02 : 16", for surfaces 30" and more

*Work surface support.
Refer to [Appendix H](#) for specification rules.*

To be used at the end of a surface when there is no electrical management.

Prices

Code	
CNTC01	23
CNTC02	30

How to Order

CNTC01 WH
CNTC02 BL
 SN (std)

<input type="text"/>	<input type="text"/>
----------------------	----------------------

Product Metal

Example CNTC01 SN

Supports

Shelf Support

CNTSH

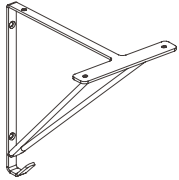

Manufacturing Standards

Shelf Support:

- Metal, finishes: Satin Nickel (SN), Black (BL) or White (WH);
- with hook at the base of the support;
- without pointing for assembly;
- For surface with a depth of 15";
- Support dimensions: 9"x9".

Prices

Code	
CNTSH SN	69
CNTSH BL	69
CNTSH WH	69

How to Order

CNTSH	WH BL SN
Product	Metal

Example CNTSH SN

Supports

Stiffener

RSTF

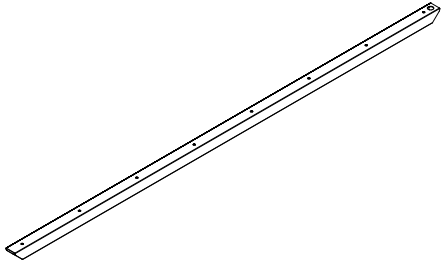

Manufacturing Standards

- Stiffener:
- Metal, Satin Nickel finish;
 - Suggested for work surfaces 54" or more;
 - Installation hardware included.

Prices

Dimensions	
A	
40	88
46	88
52	88
58	88
64	88
70	88

How to Order

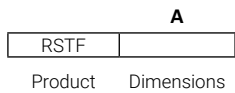

Example RSTF 40

Supports

Flush Plates

FP2BL

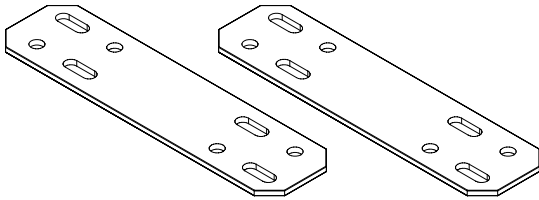

Manufacturing Standards

- 2 Flush Plates with Screws:
- Metal support, Black finish;
 - Without pointing for assembly.

Work surface support.

Refer to [Appendix H](#) for specification rules.

Prices

Code

FP2BL

11

How to Order

FP2BL

Product

Example FP2BL

Independant Pedestals

Independant E pedestal

EIND

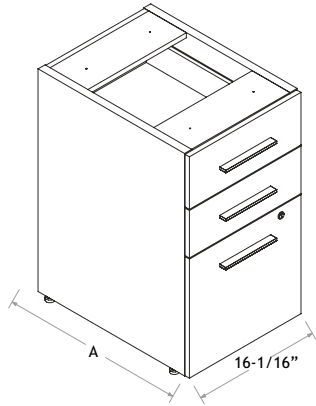

Color Combinaison

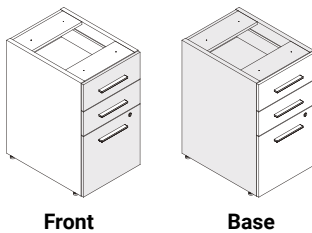

Depth of Leg

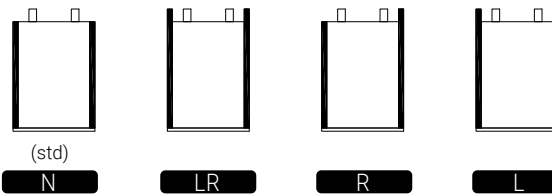

Manufacturing Standards

- Independant pedestal with 2 utility drawers and file drawer:
- Pedestal without top;
 - 2-3/8" back and sides recess for wire management;
 - Fix to the panel using L bracket. The positioning brackets on the back allow you to leave a 2-3/8" wiring space and to attach the pedestal to the division panels or to the low walls.
 - 14-3/32"H opening in the back;
 - White nylon levelers;
 - Handles H071BL;
 - Lock;
 - Height: 28"H.
- Attention: This pedestal is designed for use under a work surface or a return. A fitted surface - 16" wide - is not possible due to the width of the pedestal (16 1/16").

To use with power walls and division panels.

Remove lock as option, no extra charge.

Specify if different handle desired (no extra charge, [see p. 94](#)).

Prices

Dimensions	
A	
20	882
24	894
30	905

How to Order

XT	EIND	A	R L LR N (std)	H071BL (std)	N LKSN LKBL (std)
Series	Product	Depth	Full depth placket	Handle	Lock
Example XT	EIND	20	N	H071BL	LKBL

Independant Pedestals

Independant F pedestal

FIND

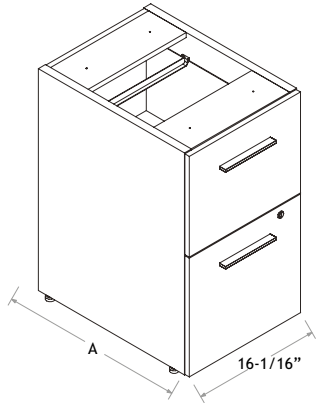

Color Combinaison

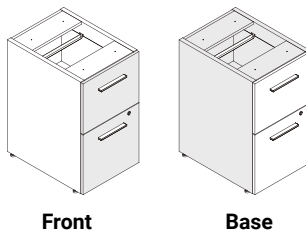

Depth of Leg

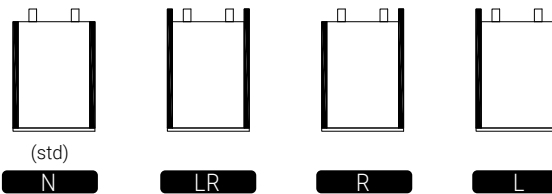

Manufacturing Standards

Independant pedestal with 2 file drawers:

- Pedestal without top;
- 2-1/2" back and sides recess for wire management;
- Fix to the panel using L bracket. The positioning brackets on the back allow you to leave a 2-3/8" wiring space and to attach the pedestal to the division panels or to the low walls.
- 14-3/32"H opening in the back;
- White nylon levelers;
- Handles H071BL;
- Lock;
- Height: 28"H.
- Attention: This pedestal is designed for use under a work surface or a return. A fitted surface - 16" wide - is not possible due to the width of the pedestal (16 1/16").

To use with power walls and division panels.

Remove lock as option, no extra charge.

Specify if different handle desired (no extra charge, [see p. 94](#)).

Prices

Dimensions

A	
20	869
24	881
30	893

How to Order

XT	FIND	A	R L LR N (std)	H071BL (std)	N LKSN LKBL (std)	
Series	Product	Depth	Full depth placket	Handle	Lock	
Example	XT	FIND	20	N	H071BL	LKBL

Independant Pedestals

Independant pedestal with 1 pigeonhole, 1 utility drawer Pedestal without top

PGDIND

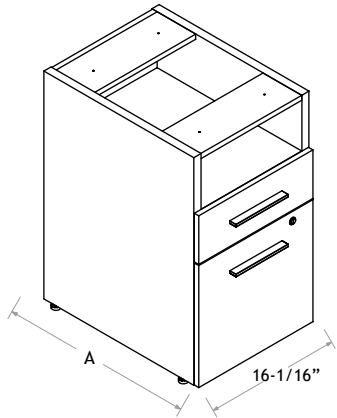

Color Combinaison

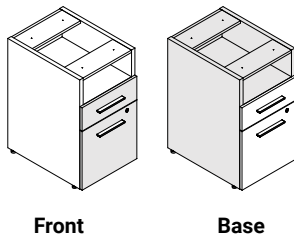

Depth of Leg

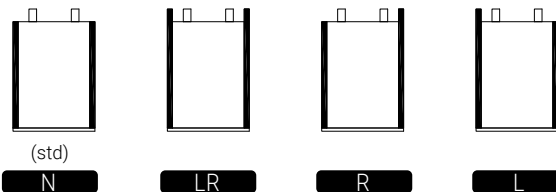

Manufacturing Standards

- Independant pedestal with 1 pigeonhole, 1 utility drawer Pedestal without top;
- Pedestal without top;
 - Pigeonhole height: 6-1/8;
 - 2-1/2" back and sides recess for wire management;
 - Fix to the panel using L bracket. The positioning brackets on the back allow you to leave a 2-3/8" wiring space and to attach the pedestal to the division panels or to the low walls.
 - 14-3/32"H opening in the back;
 - White nylon levelers;
 - Handles H071BL;
 - Lock;
 - Height: 28"H.
- Attention: This pedestal is designed for use under a work surface or a return. A fitted surface - 16" wide - is not possible due to the width of the pedestal (16 1/16").

To use with power walls and division panels.

Remove lock as option, no extra charge.

Specify if different handle desired (no extra charge, [see p. 94](#)).

Prices

Dimensions	
A	
20	882
24	894
30	905

How to Order

Series	Product	Depth	Full depth packet	Handle	Lock
XT	PGDIND	A	R L LR N (std)	H071BL (std)	N LKSN LKBL (std)
Example	XT	PGDIND	20	H071BL	LKBL

Independant Pedestals

Independant cabinet with 1 utility drawer and 1 open space

UOIND

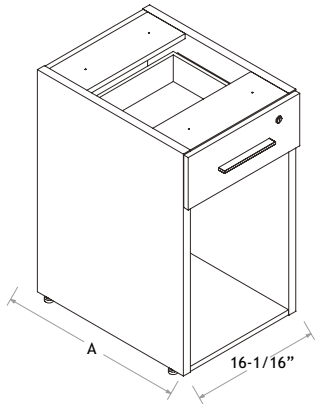

Color Combaision

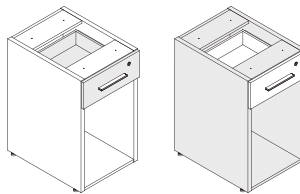

Front

Base

Depth of Leg

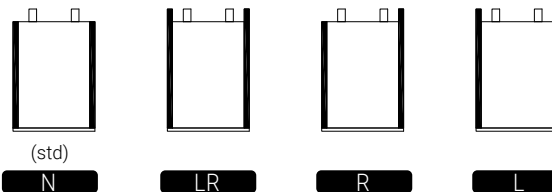

(std)

N

LR

R

L

Manufacturing Standards

- Independant cabinet with 1 utility drawer and 1 open space:
- Pedestal without top;
 - Height of open space: 19-3/4"H;
 - 2-1/2" back and sides recess for wire management;
 - Fix to the panel using L bracket. The positioning brackets on the back allow you to leave a 2-3/8" wiring space and to attach the pedestal to the division panels or to the low walls.
 - 14-3/32"H opening in the back, concealed with a removable panel;
 - White nylon levelers;
 - Handles H071BL;
 - Lock;
 - Height: 28"H.
- Attention: This pedestal is designed for use under a work surface or a return. A fitted surface - 16" wide - is not possible due to the width of the pedestal (16 1/16").

To use with power walls and division panels.

Remove lock as option, no extra charge.

Specify if different handle desired (no extra charge, [see p. 94](#)).

Prices

Dimensions	
A	
20	665
24	722
30	780

How to Order

XT	UOIND	A	R L LR N (std)	H071BL (std)	N LKSN LKBL (std)
Series	Product	Depth	Full depth placket	Handle	Lock
Example XT	UOIND	20	N	H071BL	LKBL

Independant Pedestals

Independant cabinet with 1 door

ARLIND

ARRIND

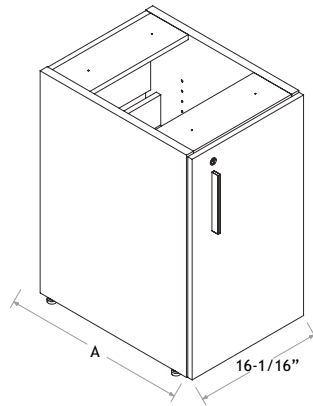
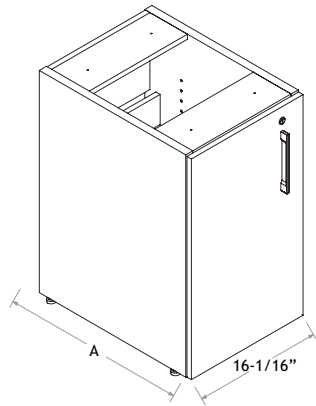

Color Combinaison

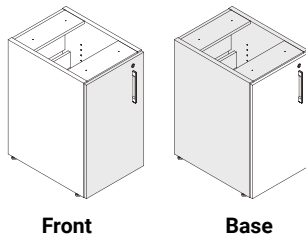

Front

Base

Depth of Leg

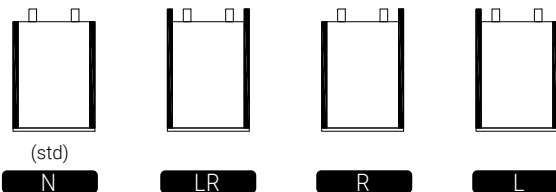

(std)

N

LR

R

L

Manufacturing Standards

Independant cabinet:

- Cabinet without top;
- 2-3/8" back and sides recess for wire management;
- Fix to the panel using L bracket. The positioning brackets on the back allow you to leave a 2-3/8" wiring space and to attach the pedestal to the division panels or to the low walls.
- 14-3/32"H opening in the back, concealed with a removable panel;
- White nylon levelers;
- Handles H071BL;
- Lock;
- Height: 28"H;
- Adjustable shelf.
- Attention: This pedestal is designed for use under a work surface or a return. A fitted surface - 16" wide - is not possible due to the width of the pedestal (16 1/16").

To use with power walls and division panels.

Remove lock as option, no extra charge.

Specify if different handle desired (no extra charge, [see p. 94](#)).

Prices

Dimensions	
A	
20	635
24	693
30	751

How to Order

	ARLIND ARRIND	A	R L LR N (STD)	H071BL (std)	N LKSN LKBL (STD)	
Series	Product	Depth	Full depth placket	Handle	Lock	
Example	XT	ARLIND	20	N	H071BL	LKBL

Independant Pedestals

Independant cabinet with two doors

ARIND

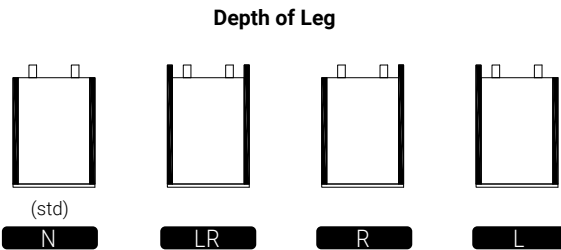
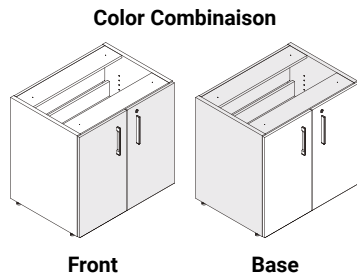
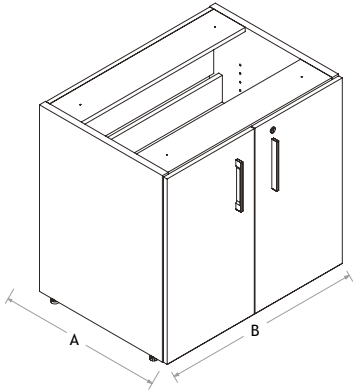

Manufacturing Standards

- Independant cabinet with two doors:
- Cabinet without top;
 - 1 adjustable shelf;
 - 2-3/8" back and sides recess for wire management;
 - Fix to the panel using L bracket. The positioning brackets on the back allow you to leave a 2-3/8" wiring space and to attach the pedestal to the division panels or to the low walls.
 - 14-3/32"H opening in the back, concealed with a removable panel;
 - White nylon levelers;
 - Handles H071BL;
 - Lock;
 - Height: 28"H.

To use with power walls and division panels.

Remove lock as option, no extra charge.

Specify if different handle desired (no extra charge, [see p. 94](#)).

Prices

Dimensions	
A	B
20 24	767
20 30	820
20 36	855
20 42	890
24 24	790
24 30	843
24 36	878
24 42	914

How to Order

XT	A	B	ARIND	R L LR N (std)	H071BL (std)	N LKSN LKBL (std)
Series	Depth	Width	Product	Full depth placket	Handle	Lock
Example XT	20	24	ARIND	N	H071BL	LKBL

Independant Pedestals

Independant bookcase

BBLIND

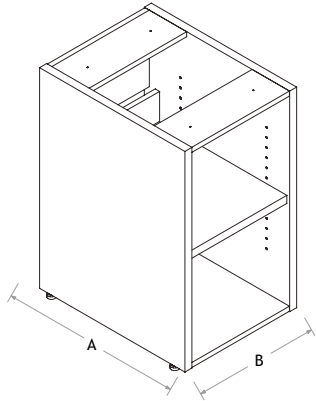

Color Combaision

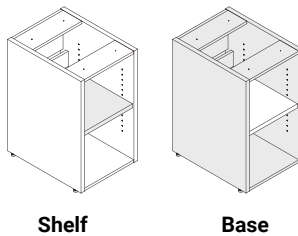

Depth of Leg

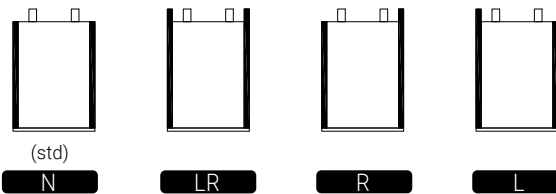

Manufacturing Standards

Independant bookcase:

- Bookcase without top;
- 1 adjustable shelf, 1" thick;
- 2-3/8" back and sides recess for wire management;
- Fix to the panel using L bracket. The positioning brackets on the back allow you to leave a 2-3/8" wiring space and to attach the pedestal to the division panels or to the low walls.
- 14-3/32"H opening in the back, concealed with a removable panel;
- White nylon levelers;
- Height: 28"H.

To use with power walls and division panels.

Prices

Dimensions	
A	B
20 16	578
20 24	635
24 16	635
24 24	693
30 16	693
30 24	751

How to Order

XT	A	B	BBLIND	R L LR N (std)
Series	Depth	Width	Product	Full depth placket

Example XT 20 16 BBLIND N

Independant Pedestals

Independant lateral Filing cabinet

CLIND

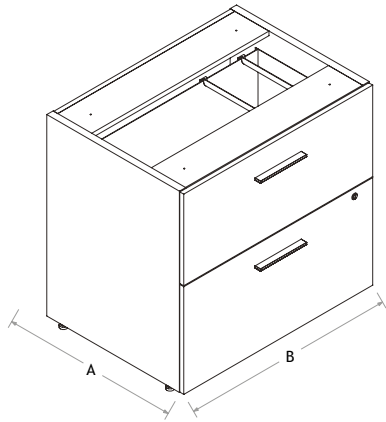

Color Combainson

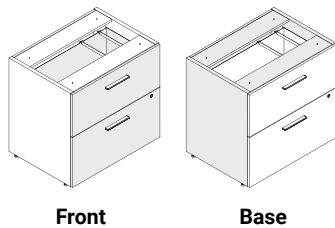

Front

Base

Depth of Leg

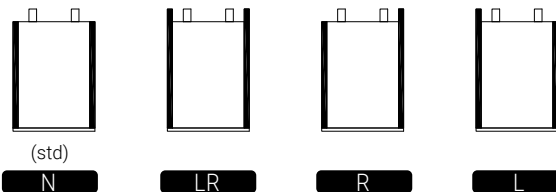

(std)

N

LR

R

L

Manufacturing Standards

Independant Lateral Filing cabinet:

- Cabinet without top;
- 2 lateral filing drawers;
- 2 crossbars per file drawer;
- 2-3/8" back and sides recess for wire management;
- Fix to the panel using L bracket. The positioning brackets on the back allow you to leave a 2-3/8" wiring space and to attach the pedestal to the division panels or to the low walls.
- 14-3/32"H opening in the back;
- White nylon levelers;
- Handles H071BL;
- Lock;

To use with power walls and division panels.

Remove lock as option, no extra charge.

Specify if different handle desired (no extra charge, [see p. 94](#)).

Prices

Dimensions	
A	B
20 30	960
20 36	1038
20 42	1118
<hr/>	
24 30	983
24 36	1062
24 42	1141

How to Order

XT	A	B	CLIND	R L LR N (STD)	H071BL (std)	N LKSN LKBL (std)
Series	Depth	Width	Product	Full depth placket	Handle	Lock
Example XT	20	30	CLIND	N	H071BL	LKBL

Mobile pedestal



Mobile pedestal with cabinet

MOBARL

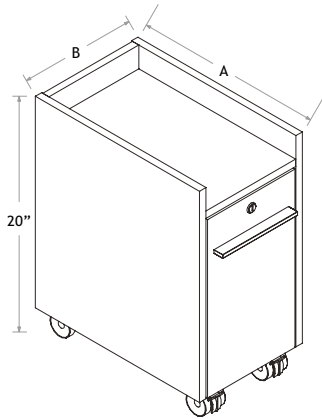

MOBARR

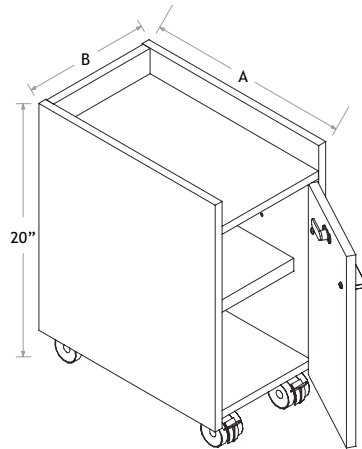

Manufacturing Standards

Mobile pedestal with 1-door cabinet:

- 1 storage on top;
- 4 black locking casters;
- Handle H071BL;
- Lock;
- Height: 20"H;
- 1 adjustable shelf.

Remove lock as option, no extra charge.

Specify if different handle desired (no extra charge, [see p. 94](#)).

Prices

Dimensions		
A	B	C
16	10	20
649		
16	16	20
660		

Color Combination

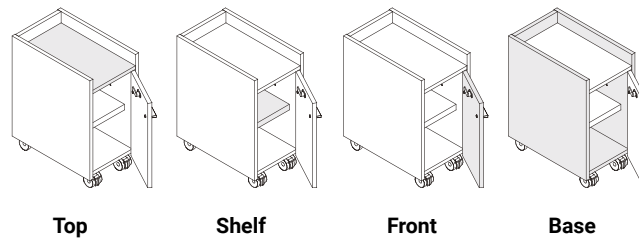

Top

Shelf

Front

Base

How to Order

	AB	MOBARL MOBARR	H071BL (std)	N LKSN LKBL (std)
XT				
Series	Dimensions	Product	Handle	Lock
Example XT	1610	MOBARL	H071BL	LKBL

Mobile pedestal



Mobile pedestal with 1 fixed shelf and 1 utility drawer

MOBSPU

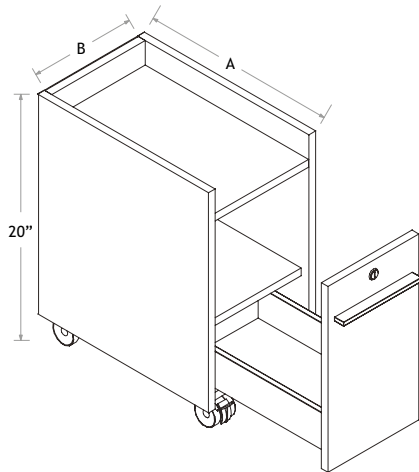

Manufacturing Standards

Mobile pedestal with 1 fixed shelf and 1 utility drawer at the bottom:

- 1 storage space on top (2"H);
- 1 utility drawer at the bottom;
- 4 black casters with lock;
- Handle H071BL;
- Lock;
- Height: 20"H.

Remove lock as option, no extra charge.

Specify if different handle desired (no extra charge, [see p. 94](#)).

Color Combination

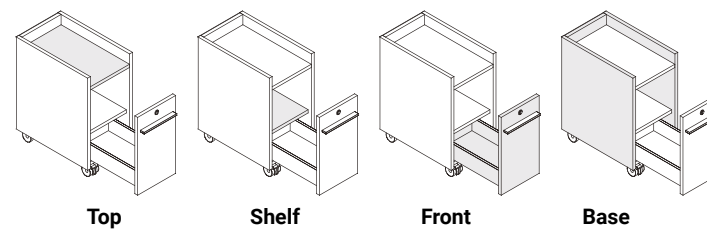

Top

Shelf

Front

Base

Prices

Dimensions		
A	B	C
16	10	20
16	16	20

How to Order

Series	Dimensions	Product	Handle	Lock
Example XT	1610	MOBSPU	H071BL	LKBL

High Pedestals

High Pedestals

OK25

KO25

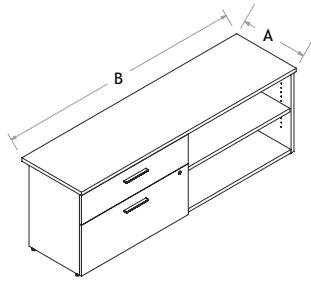
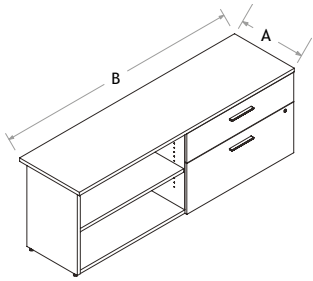

Color Combination

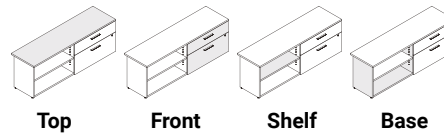

Top

Front

Shelf

Base

Depth of Leg

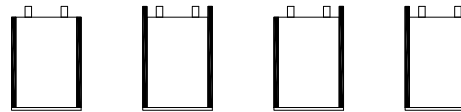

(std)

N

\$0

LR

\$0

R

\$0

L

\$0

Manufacturing Standards

High Pedestal:

- 1 open storage with 1 adjustable shelf;
- A section with 1 utility drawer with integrated dividers and 1 lateral file drawer.
- 2-3/8" back and sides recess for wire management;
- Fix to the panel using L bracket. The positioning brackets on the back allow you to leave a 2-3/8" wiring space and to attach the pedestal to the division panels or to the low walls.
- 12.5"H opening in the back, concealed with a removable panel on bookcase side;
- White nylon levelers;
- H071BL Handles;
- Lock;
- Height: 25"H.

For wire access: Removable back on bookcase side and opening on cabinet side.

Remove lock as option, no extra charge.

Specify if different handle desired (no extra charge, [see p. 94](#)).

Options

Surface 1½" for wiring

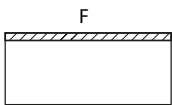

SP_

\$0

Cushion

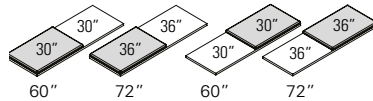

Cushion Left Cushion Right

GRA	GR1	GR2	GR3	GR4	GR5	GR6	GR7	GR8	GR9	GR10	GR11	GR12	leather
\$330	\$342	\$359	\$375	\$396	\$416	\$437	\$458	\$478	\$499	\$519	\$561	\$602	\$568
\$330	\$342	\$359	\$375	\$396	\$416	\$437	\$458	\$478	\$499	\$519	\$561	\$602	\$568

Prices

Dimensions		
A	B	C
20	60	25
1536		
20	72	25
1617		

How to Order

XT	AB	OK25 KO25	SPF SPN (std)	R L LR N (std)	CL CR N (std)	H071BL (std)	N LKS N LKBL (std)
Series	Dimensions	Product	Area Space 1½" for wiring	Full depth packet	Cushion	Handle	Lock
Example	XT	2060	OK25	SPN	N	N	H071BL
							LKBL

High Pedestals

High Pedestals

OAR25

ARO25

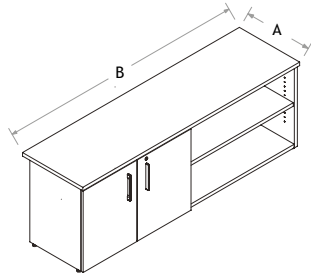
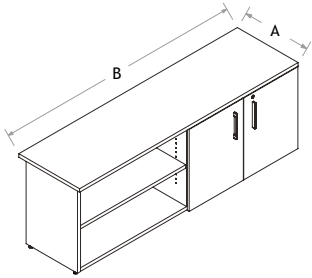

Color Combination

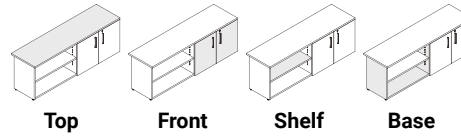

Depth of Leg

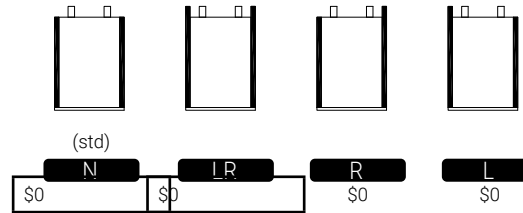

Manufacturing Standards

High Pedestal:

- An open storage with 1 adjustable shelf;
- A 2-door cabinet section with 1 adjustable shelf;
- 2-3/8" back and sides recess for wire management;
- Fix to the panel using L bracket. The positioning brackets on the back allow you to leave a 2-3/8" wiring space and to attach the pedestal to the division panels or to the low walls.
- 12.5"H opening in the back, concealed with a removable panel on bookcase side and cabinet side;
- White nylon levelers;
- H071BL Handles;
- Lock;
- Height: 25"H.

For wire access: Removable back on bookcase side and opening on the armory section.

Remove lock as option, no extra charge.

Specify if different handle desired (no extra charge, [see p. 94](#)).

Options

Surface 1 1/2" for wiring

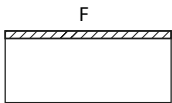

SP_ \$0

Cushion

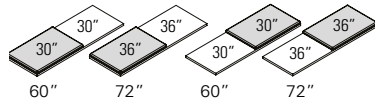

Cushion Left Cushion Right

GRA	GR1	GR2	GR3	GR4	GR5	GR6	GR7	GR8	GR9	GR10	GR11	GR12	leather
\$330	\$342	\$359	\$375	\$396	\$416	\$437	\$458	\$478	\$499	\$519	\$561	\$602	\$568
\$330	\$342	\$359	\$375	\$396	\$416	\$437	\$458	\$478	\$499	\$519	\$561	\$602	\$568

Prices

Dimensions	A	B	C
20 60 25			1386
20 72 25			1482

How to Order

XT	AB	OAR25 ARO25	SPF SPN (std)	R L LR N (std)	CL CR N (std)	H071BL (std)	N LKS LKBL (std)	
Series	Dimensions	Product	Area Space 1 1/2" for wiring	Full depth placket	Cushion	Handle	Lock	
Example	XT	2060	OAR25	SPN	N	N	H071BL	LKBL

Benches

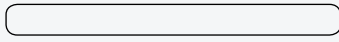

Benches with open storage

BO

BOO

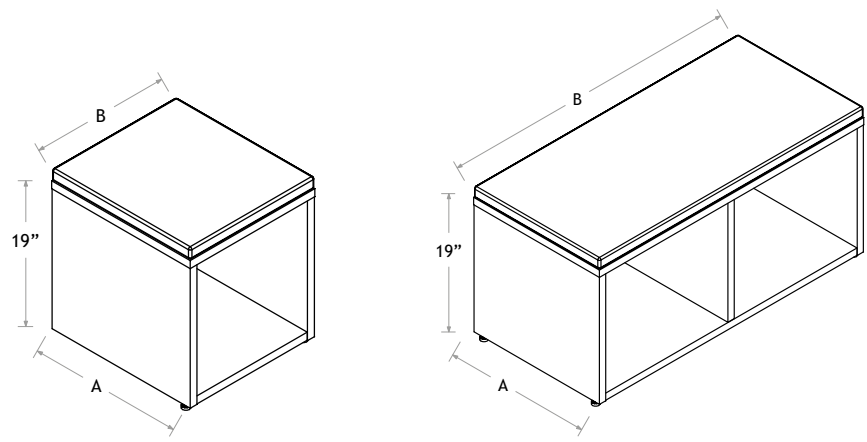

Manufacturing Standards

- Bench with open storage:
- 1" laminate frame with full back;
 - 1-1/2"H Full cushion;
 - Open storage with interior space 18" x 16";
 - White nylon levelers.

Color Combinaison

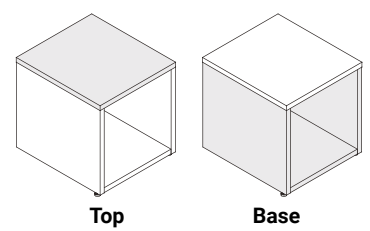

Prices

Dimensions			GRA	GR1	COM GR2	GR3	GR4	GR5	GR6	GR7	GR8	GR9	GR10	GR11	GR12	Cuir	Leather
BO																	
A	B	C															
20	18	19	380	397	419	441	469	496	524	551	579	606	634	689	744		689
BOO																	
A	B	C															
20	42	19	617	642	675	708	749	791	832	873	914	956	997	1079	1162		1093

How to Order

Series	Dimensions	Product
XT	AB	BO BOO

Example XT 2018 BO

Benches

Benches with file drawer

BF

BFF

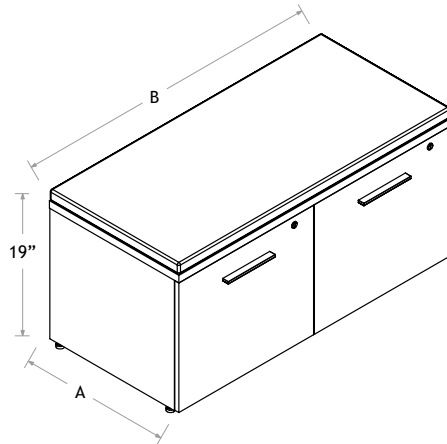
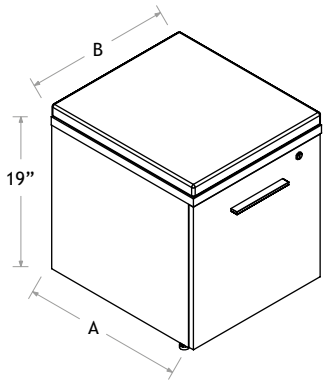

Manufacturing Standards

- Bench with open storage:
- 1" laminate frame with full back;
 - 1-1/2"H Full cushion;
 - 18"W: 1 file drawer (BF);
 - 42"W: 2 file drawers (BFF);
 - Handle H071BL;
 - White nylon levelers;
 - Lock.

Remove lock as option, no extra charge.

Specify if different handle desired (no extra charge, [see p. 94](#)).

Color Combination

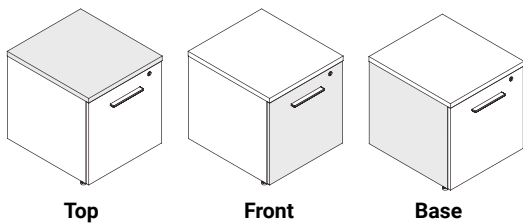

Top

Front

Base

Prices

BF

Dimensions			COM												Cuir	
A	B	C	GRA	GR1	GR2	GR3	GR4	GR5	GR6	GR7	GR8	GR9	GR10	GR11	GR12	Leather
20	18	19	588	605	627	649	677	704	732	759	787	814	842	897	952	906

BFF

Dimensions			COM												Cuir	
A	B	C	GRA	GR1	GR2	GR3	GR4	GR5	GR6	GR7	GR8	GR9	GR10	GR11	GR12	Leather
20	42	19	1044	1069	1102	1135	1176	1218	1259	1300	1341	1383	1424	1506	1589	1520

How to Order

XT	AB	BF BFF	H071BL (std)	N LKSN LKBL (std)
Series	Dimensions	Product	Handle	Lock
Example XT	2018	BF	H071BL	LKBL

Benches

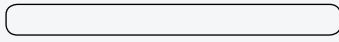

Bottomless open benches

BLEO

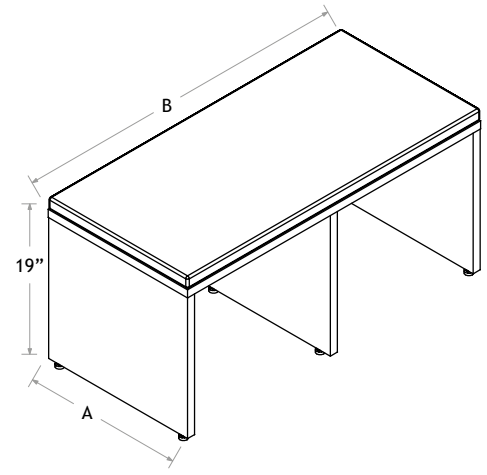

Manufacturing Standards

Bottomless open bench:

- 1" laminate frame with full back;
- 1-1/2"H Full cushion;
- Bottomless open storage with interior space 19-15/32" x 19-15/32";
- White nylon levelers;
- For storage of LEO18 bench.

Compatible with LEO18 and LEOC18 benches.

Color Combinaison

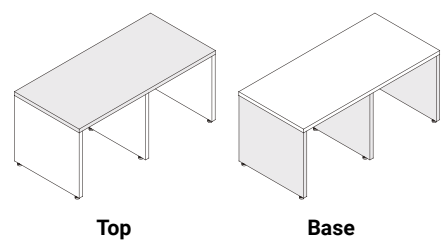

Prices

BLEO

Dimensions			COM												Cuir	
A	B	C	GRA	GR1	GR2	GR3	GR4	GR5	GR6	GR7	GR8	GR9	GR10	GR11	GR12	Leather
20	42	19	470	495	528	561	602	644	685	726	767	809	850	932	1015	946

How to Order

	AB	BLEO
XT		
Series	Dimensions	Product

Example XT 2042 BLEO

Storage towers

Sliding storage

SL01L

SL01R

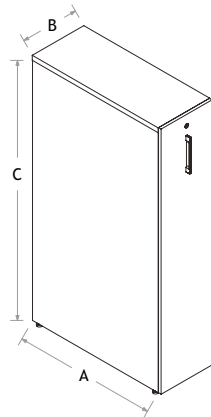
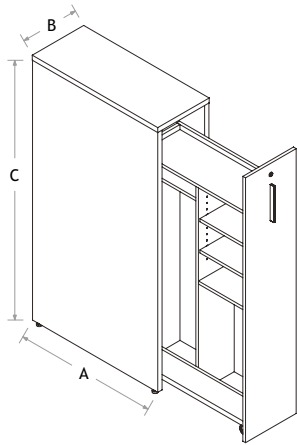

Color Combination

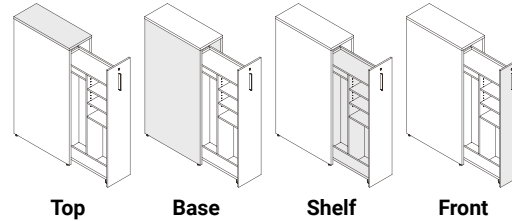

Manufacturing Standards

Sliding storage:

- 1 cloakroom section with 1 fixed shelf and a hook;
- 1 storage section with 1 fixed shelf and:
 - 42"H : 1 adjustable shelf
 - 54"H : 2 adjustable shelves
- Removable panel at the back for wire access. There is no removable back if the tab notch option is chosen;
- Unit on slides and casters, with soft close system;
- Handle H071BL;
- Lock;
- White nylon levelers.

Remove lock as option, no extra charge.

Specify if different handle desired (no extra charge, [see p. 94](#)).

Options

Tab with notch for wire management

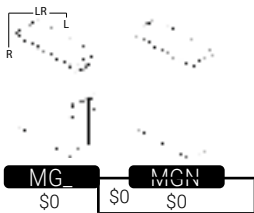

Cutouts for socket (plug not included)

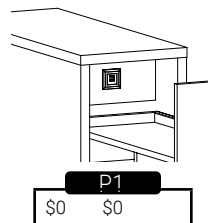

Prices

Dimensions

A	B	C
30	12	42
30	12	54

How to Order

Series	Dimensions	Product	Tab with notch for wire management	Cutout for socket	Handle	Lock
Example XT	301242	SL01L	MGN	N	H071BL	LKBL

Storage towers

Cabinet with coat hook

ARHL

ARHR

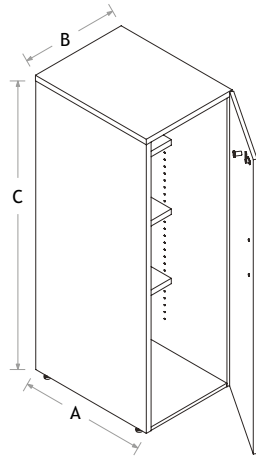
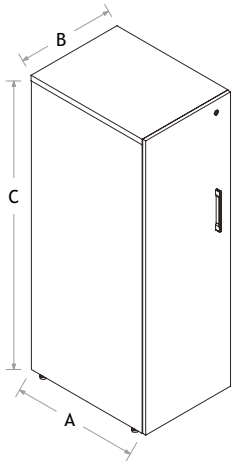

Color Combinaison

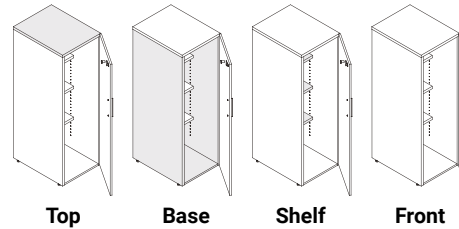

Manufacturing Standards

Cabinet with coat hook:

- Cabinet with 1 door;
- 2 adjustable shelves 42"H;
- 3 adjustable shelves 54"H;
- Coat hook on cabinet door;
- Ventilation grill at the bottom;
- Handle H071BL;
- Lock;
- White nylon levelers;
- Space of 10-1/4" in front of the adjustable shelves for a mantel. (For the 2 depths, the shelves change in depth).

Remove lock as option, no extra charge.

Specify if different handle desired (no extra charge, [see p. 94](#)).

Options

Tab with notch for wire management

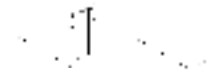

MG_ \$0

MGN \$0

Prices

Dimensions		
A	B	C
20	18	42
24	18	42
20	18	54
24	18	54

How to Order

XT	ABC	ARHL ARHR	MGR MGLR MGRR MGN (std)	H071BL (std)	N LKSN LKBL (std)
Series	Dimensions	Product	Tab with notch for wire management	Handle	Lock
Example XT	201842	ARHL	MGN	H071BL	LKBL

Storage towers

Bookcase with drawers

BBUF

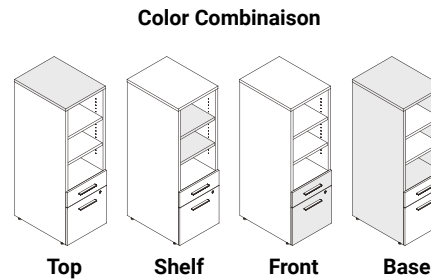
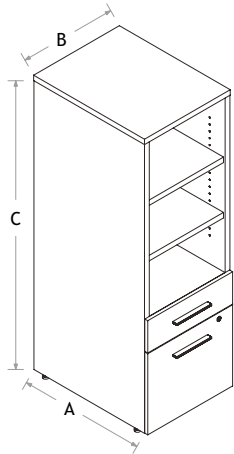

Manufacturing Standards

Bookcase with drawers:

- Open storage with 1 adjustable shelf for the 42"H cabinet, 2 adjustable shelves for the 54"H cabinet;
- 1 utility drawer;
- 1 lateral file drawer;
- Handles H071BL;
- Lock.
- White nylon levelers.

Remove lock as option, no extra charge.

Specify if different handle desired (no extra charge, [see p. 94](#)).

Options

Tab with notch for wire management

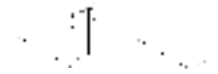
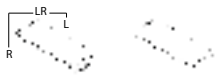

MG_
\$0

MGN
\$0

Prices

Dimensions		
A	B	C
20	18	42
24	18	42
<hr/>		
20	18	54
24	18	54

How to Order

Series	Dimensions	Product	Tab with notch for wire management	Handle	Lock
Example XT	201842	BBUF	MGN	H071BL	LKBL

Storage towers

Cabinet with drawers

ARUFL

ARUFR

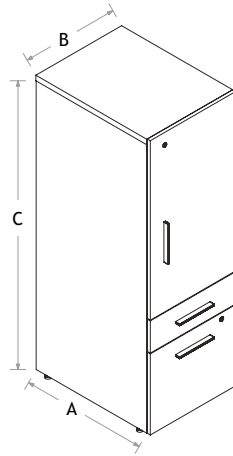
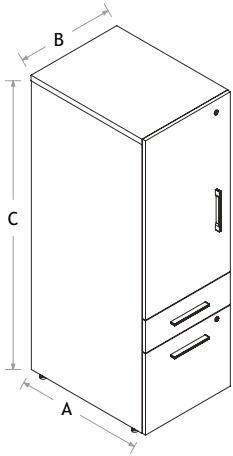

Color Combination

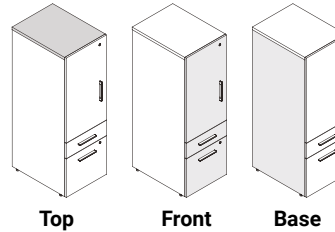

Manufacturing Standards

- Cabinet with 1 door, 1 utility drawer and 1 lateral file drawer:
- 1 cabinet section with 1 adjustable shelf for the 42"H cabinet with drawers, 2 adjustable shelves for the 54"H cabinet with drawers;
 - 1 utility drawer;
 - 1 lateral file drawer;
 - Handles H071BL;
 - Lock;
 - White nylon levelers.

Remove lock as option, no extra charge.

Specify if different handle desired (no extra charge, [see p. 94](#)).

Options

Tab with notch for wire management

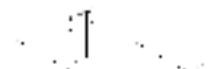

MG_
\$0

MGN
\$0

Prices

Dimensions		
A	B	C
20	18	42
24	18	42
20	18	54
24	18	54

How to Order

XT	ABC	ARUFL ARUFR	MGR MGLR MGRR MGN (std)	H071BL (std)	N LKSN LKBL (std)
Series	Dimensions	Product	Tab with notch for wire management	Handle	Lock
Example XT	201842	ARUFR	MGN	H071BL	LKBL

Islands Stations

Island station

USF

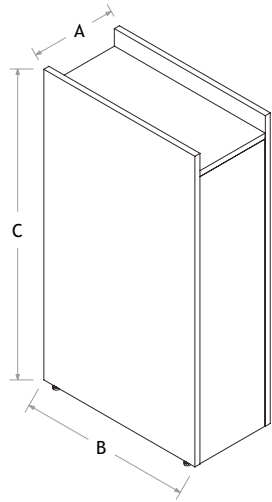

Color Combinaison

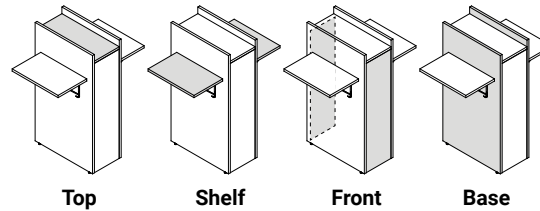

Manufacturing Standards

Island station :

- 1" laminate frame;
- Removable end panels for wire management;
- White nylon levelers;

Options :

Outdoor shelf height: 29" (Island Station 36"H & 42"H), 42" (Island Station 54"H).

Outdoor shelf depth: 15".

Cutouts for socket: 2 by side.

For outlet, please refer to the [Accessory](#) section.

Options

Cutouts for socket (plug not included)

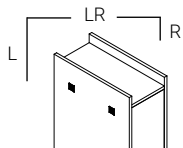

PL \$0 PR \$0 PLR \$0

Shelf

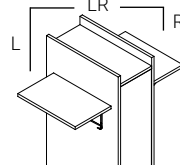

L \$179 LR \$358 R \$179

Prices

Dimensions			
A	B	C	
15	30	36	722
15	36	36	751
15	42	36	774
15	30	42	751
15	36	42	774
15	30	54	797
15	36	54	820

How to Order

XT	ABC	USF	PL PR PLR N (std)	L R LR N (std)	WH SN BL (std)
Series	Dimensions	Product	Cutout for socket	Shelf	Metal

Example XT 153036 USF N N BL

Island station with Bookcase - 1 side

USBB

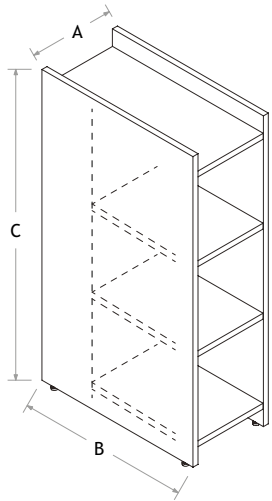

Color Combinaison

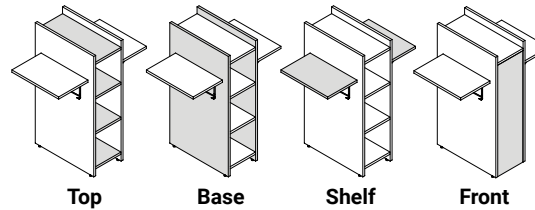

Manufacturing Standards

- Island Station with Bookcase - 1 side
- 1" laminate frame;
 - Bookcase on 1 side with:
 - 36"H: 2 open spaces 13 1/4"H (int.)
 - 42"H: 2 open spaces 16 1/4"H (int.)
 - 54"H: 3 open spaces 14 1/2"H (int.)
 - Interior fixed shelves, not full depth;
 - Removable end panel for wire management;
 - White nylon levelers.

Options :

Outdoor shelf height: 29" (Island Station 36"H & 42"H), 42" (Island Station 54"H).

Outdoor shelf depth: 15".

Cutouts for socket: 1 by side.

For outlet, please refer to the [Accessory](#) section.

Options

Cutouts for socket (plug not included)

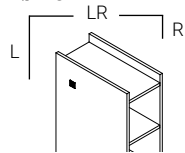

PL PR PLR
\$0 \$0 \$0

Shelf

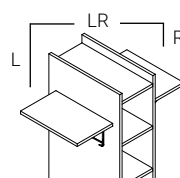

L LR R
\$179 \$358 \$179

Prices

Dimensions			Interior depth shelf:
A	B	C	
15	30	36	722 18 5/8"
15	36	36	751 21 5/8"
15	42	36	774 24 5/8"
<hr/>			
15	30	42	751 18 5/8"
15	36	42	774 21 5/8"
<hr/>			
15	30	54	797 18 5/8"
15	36	54	820 21 5/8"

How to Order

XT	ABC	USBB	PL PR PLR N (std)	L R LR N (std)	WH SN BL (std)
Series	Dimensions	Product	Cutout for socket	Shelf	Metal
Example XT	153036	USBB	N	N	BL

Islands Stations

Island station with lockers - 1 side

USLOR

USLOL

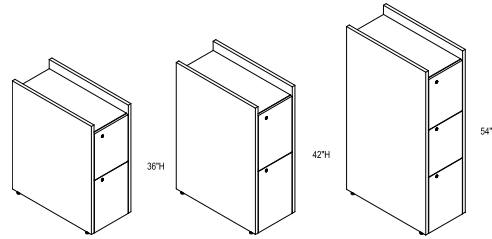
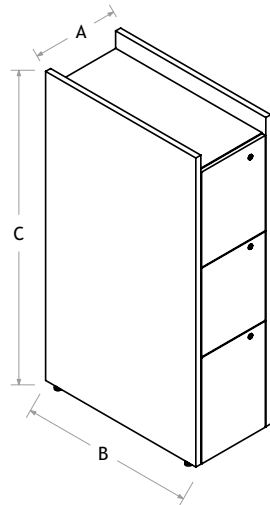
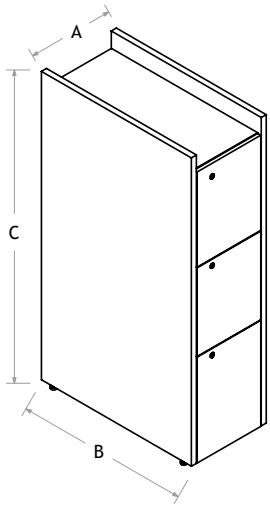

Color Combination

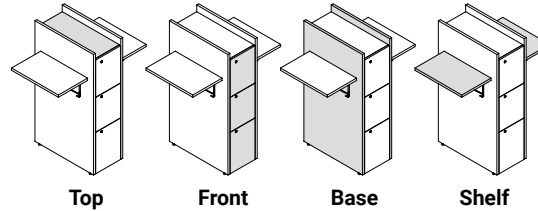

Manufacturing Standards

Island Station with lockers - 1 side:

- 1" laminate frame;
- XY'D Lockers on 1 side with:
 - 36"H: 2 open spaces 13 1/4"H (int.)
 - 42"H: 2 open spaces 16 1/4"H (int.)
 - 54"H: 3 open spaces 14 1/2"H (int.)
- Doors with key locks and push-to-open latch;
- Removable end panel for wire management;
- White nylon levelers;
- Interior shelves not full depth.
- Locker interior dimension:
 - 30"H: 18 5/16" (int.)
 - 36"H: 21 5/16" (int.)
 - 42"H: 24 5/16" (int.)



Options :

Outdoor shelf height: 29" (Island Station 36"H & 42"H), 42" (Island Station 54"H).

Outdoor shelf depth: 15".

Cutouts for socket: 1 by side.

For outlet, please refer to the [Accessory](#) section.

Options

Lock

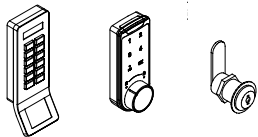

E1 \$231 ea.
E2 \$139 ea.
CMI K \$0

Cutouts for socket (plug not included)

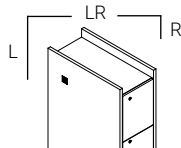

PL \$0
PR \$0
PLR \$0

Shelf

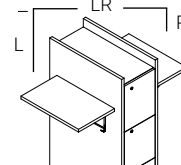

L \$179
LR \$358
R \$179

How to Order

XT	ABC	USLOR USLOL	E1 E2 N CMLK(std)	PL PR PRL N (std)	L R LR N (std)	WH SN BL (std)
Series	Dimensions	Product	Lock	Cutout for socket	Shelf	Metal
Example XT	153036	USLOR	E1	N	N	BL

Prices

Dimensions	
A	B C
15 30 36	1332
15 36 36	1448
15 42 36	1563
15 30 42	1448
15 36 42	1679
15 30 54	1597
15 36 54	1828

Accessories

Handles

HJA

Handle

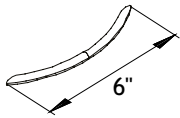

- 6" metal handle;
- 5-1/32" (128mm) center to center.

Code	\$	Description
HJA	14	<i>Satin Nickel</i>
HJAB	14	<i>Black</i>

H070

Handle

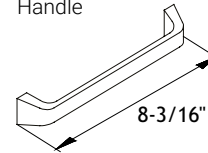

- 8-3/16" metal handle;
- 7-1/2" (190.5mm) center to center.

Code	\$	Description
H070BN	14	<i>Brushed Nickel</i>
H070CHR	14	<i>Chrome</i>

H011

Handle

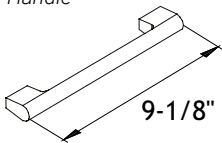

- 9-1/8" metal handle;
- 8-13/16" (224mm) center to center.

Code	\$	Description
H011	14	<i>Satin Nickel</i>

H071

Handle

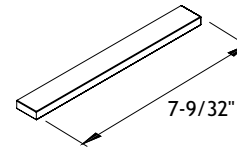

- 7-9/32" metal handle;
- 6-5/16" (160.338mm) center to center.

Code	\$	Description
H071CHR	14	<i>Chrome</i>
H071BN	14	<i>Brushed Nickel</i>
H071BL	14	<i>Black</i>
H071WH	14	<i>White</i>

H051

Handle

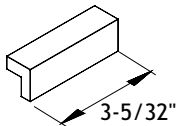

- 3-5/32" metal handle;
- 2-17/32" (64mm) center to center.

Code	\$	Description
H051CHR	14	<i>Chrome</i>
H051SN	14	<i>Satin Nickel</i>
H051BL	14	<i>Black</i>
H051WH	14	<i>White</i>

H072

Handle

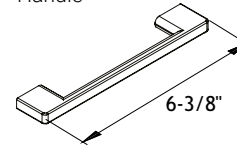

- 6-3/8" metal handle;
- 5-1/32" (127.8mm) center to center.

Code	\$	Description
H072CHR	14	<i>Chrome</i>
H072BL	14	<i>Black</i>
H072WH	14	<i>White</i>

H052

Handle

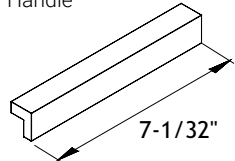

- 7-1/32" metal handle;
- 6-9/32" (160mm) center to center.

Code	\$	Description
H052CHR	14	<i>Chrome</i>
H052SN	14	<i>Satin Nickel</i>
H052BL	14	<i>Black</i>
H052WH	14	<i>White</i>

SXP002

Handle

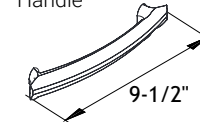

- 9-1/2" metal handle;
- 7-9/16" (192mm) center to center.

Code	\$	Description
SXP002	14	<i>Satin Nickel</i>

H060

Handle

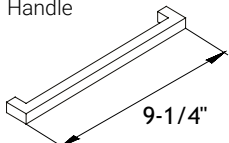

- 9-1/4" metal handle;
- 8-3/4" (222.25mm) center to center.

Code	\$	Description
H060BN	14	<i>Brushed Nickel</i>
H060CHR	14	<i>Chrome</i>

SXP003

Handle

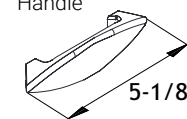

- 5-1/8" metal handle;
- 3-25/32" (96mm) center to center.

Code	\$	Description
SXP003	14	<i>Satin Nickel</i>

Accessories

Keyboard Trays

KB360M

Keyboard Tray

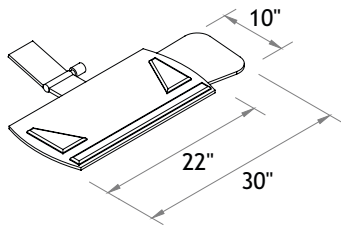

- Black plastic 24-1/2" wide retractable ergonomic keyboard;
- Lift-N-Lock spring system (no lever) to adjust height;
- Handle for easy tilt adjustment from 10° to 15°;
- 10" x 7-1/2" mouse tray;
- 19" black gel wrist rest;
- 360° rotation.

Code	\$	Description
KB360M	580	

KBMODR

Keyboard Tray

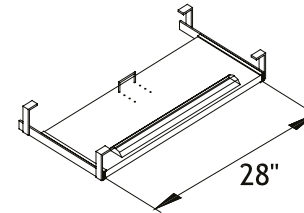

- 28" wide keyboard tray;
- 1" thick laminate;
- Adjustable height from 1-3/4 to 2-3/4" / additional 2" for slides;
- Black gel wrist rest / depth-adjustable stop handles.

Code	\$	Description
KBMODR	298	

KB

Keyboard Tray

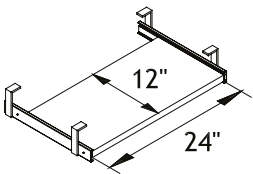

- 24" wide keyboard tray only;
- 5/8" and 1" thick laminate;
- Adjustable height from 1-3/4" to 2-3/4" / additional 2" for slides.

Code	\$	Description
KB	183	1" thick laminate
KBT	173	5/8" thick laminate

AP

Wrist Rest

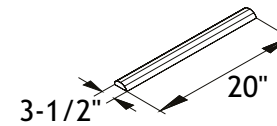

- Black gel wrist rest.

Code	\$	Description
AP	70	

KBMOD

Keyboard Tray

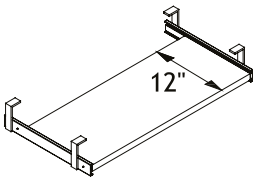

- Keyboard tray, available in lengths from minimum 24" to maximum 30";
- 5/8" and 1" thick laminate;
- Adjustable height from 1-3/4 to 2-3/4" / additional 2" for slides.

Code	\$	Description
KBMOD	217	1" thick laminate
KBMODT	208	5/8" thick laminate

To order, for example a 27" long keyboard tray, 5/8" thick laminate: KBMODT27

Accessories

CPU Holders

MCPU50

Miniature CPU Holder

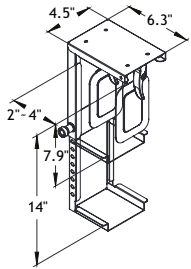

- Height adjustable: 8" - 14";
- Width adjustable: 2" - 4";
- Maximum capacity: 10 kg (22 lbs);
- Need a minimum 5" deep clearance.

Code	\$	Description
MCPU50	170	

MCPU90

CPU Holder

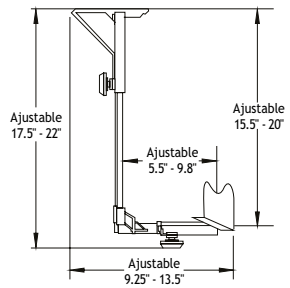

- Black metal CPU holder;
- Easy manipulation;
- Vertical adjustment:
 - Height: 15.5" x 20"
 - Width: 5.5" x 9.8"
- Horizontal adjustment:
 - Height: 17.5" x 22"
 - Width: 9.25" x 13.5"

Code	\$	Description
MCPU90	205	<i>per unit</i>

CPUIND

CPU Holder

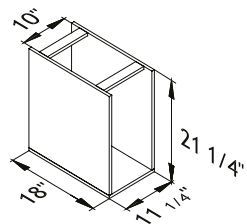

- 5/8" thick laminate CPU holder;
- 10" x 20" interior

Code	\$	Description
CPUIND	174	<i>per unit</i>

Accessories

Computer Monitor Brackets

C-1A

Computer Monitor Bracket

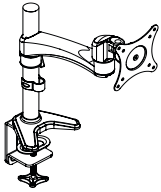

- Computer monitor bracket with fixed arm support;
- Height-adjustable arm;
- Clamp mounted;
- Finish: Black.

Code	\$	Description
C-1A	138	

C-1B

Computer Monitor Bracket

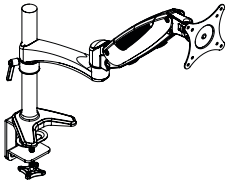

- Computer monitor bracket with flexible arm support;
- Height-adjustable arm;
- Clamp mounted;
- Finish: Black.

Code	\$	Description
C-1B	234	

C-2A

Double Computer Monitor Bracket

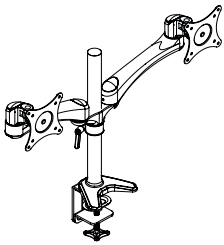

- Double computer monitor bracket with fixed arm support;
- Height-adjustable arms;
- Clamp mounted;
- Finish: Black.

Code	\$	Description
C-2A	233	

C-2B

Double Computer Monitor Bracket

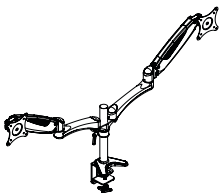

- Double computer monitor bracket with flexible arm support;
- Height-adjustable arms;
- Clamp mounted;
- Finish: Black.

Code	\$	Description
C-2B	415	

C-2A-1S

Triple Computer Monitor Bracket

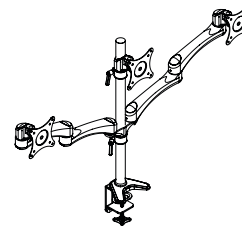

- Triple computer monitor bracket with fixed arm support;
- Height-adjustable arms;
- Clamp mounted;
- Finish: Black.

Code	\$	Description
C-2A-1S	401	

C-2B-1S

Triple Computer Monitor Bracket

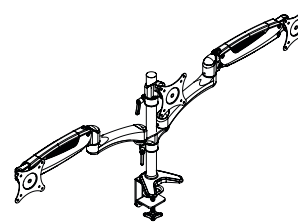

- Triple monitor bracket with 2 flexible arm supports;
- Height-adjustable arms;
- Clamp mounted;
- Finish: Black.

Code	\$	Description
C-2B-1S	454	

Accessories

Computer Monitor Brackets

BRSC1M4

Monitor Arm

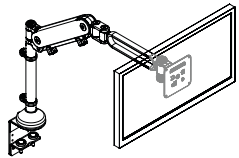

- Monitor arm with height-adjustable arm, clamp-mounted;
- Finish: Satin nickel.

Code	\$	Description
BRSC1M4	678	

This is a Human Scale product.

BRSC1M7

Monitor Arm

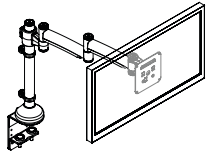

- Monitor arm with fixed-height arm, clamp-mounted;
- Finish: Satin nickel.

Code	\$	Description
BRSC1M7	481	

This is a Human Scale product.

BRSC2M4

Double Monitor Arm

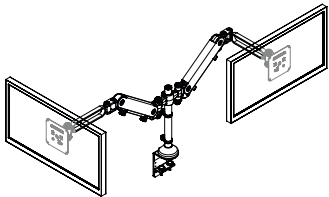

- Double monitor arm with height-adjustable arm, clamp-mounted;
- Finish: Satin nickel.

Code	\$	Description
BRSC2M4	1191	

This is a Human Scale product.

BRSC2M7

Double Monitor Arm

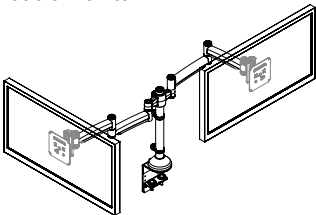

- Double monitor arm with fixed-height arm, clamp-mounted;
- Finish: Satin nickel.

Code	\$	Description
BRSC2M7	740	

This is a Human Scale product.

BRS1M4

Computer Monitor Bracket

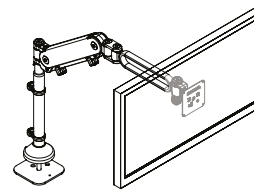

- Computer monitor bracket with height-adjustable arm;
- Grommet mounted;
- Finish: Satin Nickel.

Code	\$	Description
BRS1M4	651	

This is a Human Scale product.

BRS1M7

Computer Monitor Bracket

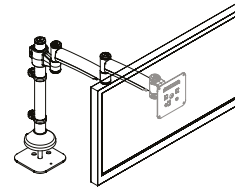

- Computer monitor bracket with fixed-height arm;
- Grommet mounted;
- Finish: Satin Nickel.

Code	\$	Description
BRS1M7	447	

This is a Human Scale product.

BRS2M4

Double Computer Monitor Bracket

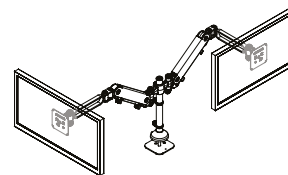

- Double computer monitor bracket with height-adjustable arm;
- Grommet mounted;
- Finish: Satin Nickel.

Code	\$	Description
BRS2M4	1185	

This is a Human Scale product.

BRS2M7

Double Computer Monitor Bracket

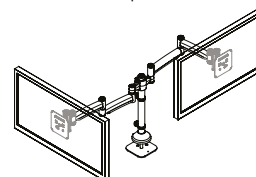

- Double computer monitor bracket with fixed height;
- Grommet mounted;
- Finish: Satin Nickel.

Code	\$	Description
BRS2M7	706	

This is a Human Scale product.

Accessories



Miscellaneous Accessories

LK

Lock/key

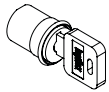

- Locks with keys
- Finish: Satin nickel or black finish;
- Additional locks, sold separately or factory installed;
- Please specify the type of furniture on which the will be installed.

Code	\$	Description
LKSN	43	Satin Nickel lock (factory installed)
LKBL	43	Black lock (factory installed)
LKSNF	27	Satin Nickel front lock
LKBLF	27	Black front lock
LKSNP	27	Satin Nickel door lock
LKBLP	27	Black door lock
KEY	19	Set of 2 keys - #501 - 600
SERR 010	19	1 master key



TCPM

Sliding Drawer

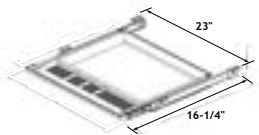

- Black plastic sliding drawer with steel ball bearing slides.

Code	\$	Description
TCPM	183	

SWV

Swivel Organizer Tray

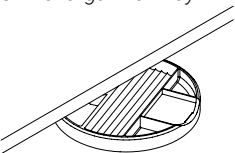

- Storage drawer that rotate 360 degrees;
- Mounts flush to the edge;
- Dimensions: 7-1/2"D x 8-7/8"W x 1"H.

Code	\$	Description
SWV	63	

SB

Suspension Bars

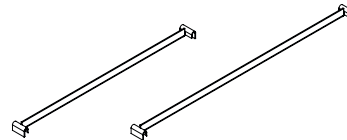

- Short suspension bars: 1 or 2 suspension bars for a left/right filing for a regular file drawer;
- Long suspension bars: 1 or 2 suspension bars for a front/back filing for a lateral file drawer.

Code	\$	Description
SBV1	7	1 short suspension bar
SBV2	14	2 short suspension bars
SBH1	7	1 long suspension bar
SBH2	14	2 long suspension bars

IGS

Installation guide for surface supports



- Compatible with; CNT01/CNT02/CNT03/CNTC01/CNTC02;
- 1" laminate;
- White nylons levelers;
- Dimensions: 10"W x 28" H;
- It is recommended for every 10 workstations to have 1x IGS.

Code	\$	Description
IGS	116	

IGWM

Installation guide for 1 1/2" wire management space for surfaces

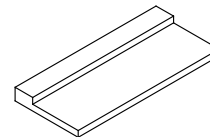

- 1" laminate;
- Dimensions: 5-3/8" D x 12"L;
- It is recommended for every 10 workstations to have 2x IGWM.

Code	\$	Description
IGWM	46	



Miscellaneous Accessories

ME2

Master key for E2 lock



Master key for E2 lock:

- To unlock and reinitialise E2 electronic lock;

Code	\$	Description
ME2	224	

CHE1

Charger for E1 lock



- Charger for E1 lock;
- Emergency battery charger to unlock E1 lock.

Code	\$	Description
CHE1	112	

Accessories

Electrical Accessories

BE-KDHB-1

Single sided power block (1)

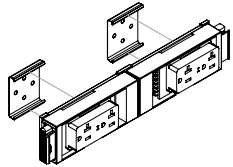

Set including:

- Single sided power block (1);
- 2 Duplex -1 circuit;
- 2 mounting plates;
- Max. 10 duplex per circuit (5 double half power block BE-KDHB-1).

Code	\$	Description
BE-KDHB-1-BL	197	
BE-KDHB-1-WH	208	



BE-KDHB-4

Single sided power block (2)

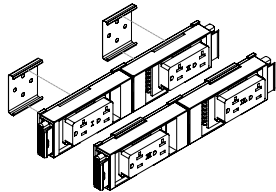

Set including:

- Single sided power block (2);
- 4 Duplex -1 of each circuit;
- 4 Mounting plates;
- Max. 40 duplex (20 double half power block).

Code	\$	Description
BE-KDHB-4-BL	395	
BE-KDHB-4-WH	405	



BE-KDBSM-1

Double sided power block

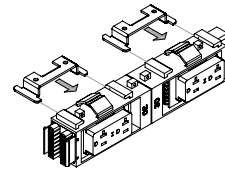

Set including:

- Double sided power block;
- 4 duplex -1 circuit;
- 2 slide mounting brackets;
- Max. 10 duplex per circuit (2 double power block).

Code	\$	Description
BE-KDBSM-1-BL	369	
BE-KDBSM-1-WH	387	



BE-KDBSM-4

Double sided power block

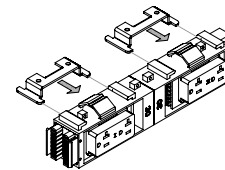

Set including:

- Double sided power block;
- 4 duplex -1 of each circuit;
- 2 slide mounting brackets;
- Max. 40 duplex (10 double power block).

Code	\$	Description
BE-KDBSM-4-BL	369	
BE-KDBSM-4-WH	387	



Accessories

Electrical Accessories

SMWM

Cable Support

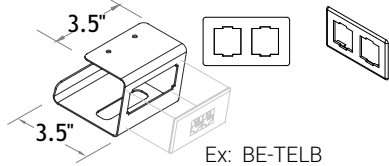

- 3.5" metal wire support with 1 telecom plate cutout;
- Satin nickel finish.

Code	\$	Description
SMWM	29	

BE-TELA

Telecom plate

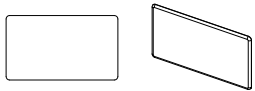

- Blank plate;
- 3-1/8" x 1-3/4";
- Colors: Black, White and Satin nickel;
- To be used with the APB, APF or AP2 access panel option of the supply walls.

Code	\$	Description
BE-TELA-BL	5	
BE-TELA-WH	5	
BE-TELA-SN	5	

BE-TELB

Telecom plate

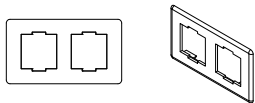

- 2 spaces to install connection ports;
- 3-1/8" x 1-3/4";
- Adapter included.
- Colors: Black, White and Satin nickel.

Code	\$	Description
BE-TELB-BL	5	
BE-TELB-WH	5	
BE-TELB-SN	5	

BE-HW

Hardwired conduit power entry



- * To be connected to an electrical box by an electrician.
- 8 wires - 4 circuits 20A;
- For 8 trac system;
- Bare wires at one end
- Male end.

Code	\$	Description
BE-HW-72	180	8 wire, 4 circuit - 72"L
BE-HW-84	197	8 wire, 4 circuit - 84"L
BE-HW-96	218	8 wire, 4 circuit - 96"L
BE-HW-120	255	8 wire, 4 circuit - 120"L
BE-HW-180	376	8 wire, 4 circuit - 180"L

BE-PI72

Corded Power entry



- Corded power entry of 72";
- Right angle 20 Amp plug;
- Male end;
- 1 circuit 20A;
- Must be plug on 20A outlet



Code	\$	Description
BE-PI72	224	

Accessories

Electrical Accessories

BE-NYHW

NYC flex hardwired power infeed



- * To be connected to an electrical box by an electrician.
- 8 wires - 4 circuits 20 A;
- Bare wires at one end;
- For 8 trac system;
- Male end.

Code	\$	Description
BE-NYHW-72	407	
BE-NYHW-84	427	
BE-NYHW-96	445	
BE-NYHW-108	465	
BE-NYHW-120	485	

BE-J

M/M jumper



- Not-adjustable;
- 8 wire - 4 circuits;
- M/M;
- For 8 trac system;
- Minimum 12" - Maximum 216".

Code	\$	Description
BE-J12	114	8 wire cable / 4 circuit - 12"L
BE-J18	123	8 wire cable / 4 circuit - 18"L
BE-J24	130	8 wire cable / 4 circuit - 24"L
BE-J36	141	8 wire cable / 4 circuit - 36"L
BE-J42	151	8 wire cable / 4 circuit - 42"L
BE-J48	161	8 wire cable / 4 circuit - 48"L
BE-J54	168	8 wire cable / 4 circuit - 54"L
BE-J60	181	8 wire cable / 4 circuit - 60"L
BE-J66	189	8 wire cable / 4 circuit - 66"L
BE-J72	198	8 wire cable / 4 circuit - 72"L
BE-J78	207	8 wire cable / 4 circuit - 78"L
BE-J84	219	8 wire cable / 4 circuit - 84"L
BE-J96	237	8 wire cable / 4 circuit - 96"L
BE-J120	277	8 wire cable / 4 circuit - 120"L
BE-J216	515	8 wire cable / 4 circuit - 216"L

BE-HC

Harness connector F/F



- Used to connect jumper cables;
- 1-1/2" x 2-1/4".

Code	\$	Description
BE-HC	51	

BE-DHB

Single sided power block

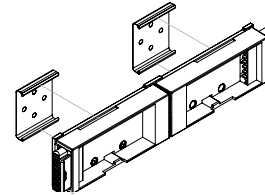

- Maximum of 2 duplex per block;
- Includes mounting plates ;
- F/F ;
- For 8-trac system ;
- Duplex ordered separately.

Code	\$	Description
BE-DHB	103	

BE-DBSM

Double sided power block

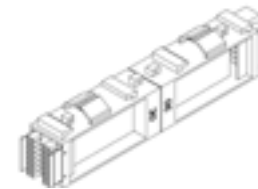

- Maximum of 4 duplex per block;
- For 8-trac system ;
- Slide mounting sold separately ;
- F/F ;
- Duplex ordered separately.

Code	\$	Description
BE-DBSM	148	

Accessories

Electrical Accessories

BE-D20-C

Duplex

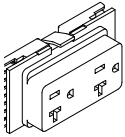

- 20 Amp;
- Height 1-1/18";
- For BE-DHB & BE-DBSM blocks ;
- Colors: Black or white ;
- Maximum of 10 Duplex per circuit.

Code	\$	Description
BE-D20-C-1-BL	47	Circuit 1 - 20A - Black
BE-D20-C-2-BL	47	Circuit 2 - 20A - Black
BE-D20-C-3-BL	47	Circuit 3 - 20A - Black
BE-D20-C-4-BL	47	Isolated Circuit 4 - 20A - Black
BE-D20-C-1-WH	53	Circuit 1 - 20A - White
BE-D20-C-2-WH	53	Circuit 2 - 20A - White
BE-D20-C-3-WH	53	Circuit 3 - 20A - White
BE-D20-C-4-WH	53	Isolated Circuit 4 - 20A - White

BE-SM58-2

Slide mount bracket

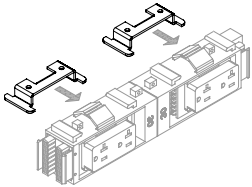

- 2 brackets;
- Only for the double power block (BE DBSM);
 - 5/8" height;
 - Screws included.

Code	\$	Description
BE-SM58-2	32	

WM

Velcro Tie



- Velcro tie for electrical cable;
- The non-metallic buckle is safe to use around electrical devices;
- Dimensions: 3/4" x 10";
- Color: black.

Code	\$	Description
WM	13	Unit price
WMS	14	with #8, 9/16" Robertson screw, per unit

SQE

Electric plug

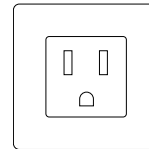

- Electric plug;
- Cable - 120";
- Finish: Black, Dusk, Navy, Storm.

Code	\$	Description
SQE-120-C	135	Black
SQE-120-JM	135	Dusk
SQE-120-JL	135	Navy
SQE-120-JK	135	Storm

SQU

USB port

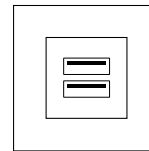

- 2 USB ports (passive);
- USB M/F cable - 72";
- Finish: Black, Dusk, Navy, Storm.

Code	\$	Description
SQU-72-C	222	Black
SQU-72-JM	222	Dusk
SQU-72-JL	222	Navy
SQU-72-JK	222	Storm

BR1

Branch unit

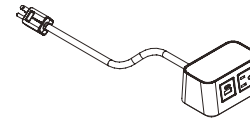

- 1 power outlet / 1 dual charger USB-a+;
- Table top with braided storm 120 IN power cord.

Code	\$	Description
BR1BL	476	Black
BR1WH	476	White

BR2

Branch unit

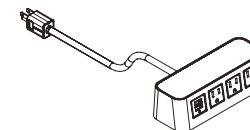

- 3 power outlet / 1 dual charger USB-a;
- Table top with braided storm 120 IN power cord.

Code	\$	Description
BR2BL	610	Black
BR2WH	610	White

Accessories

Electrical Accessories

BCSS1BL

Communication Box

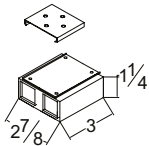

- Communication box to be installed under surface;
- 2 empty telecommunication outlets (outlets not included);
- 15A/125V;
- 1 set of universal adapters.

Code	\$	Description
BCSS1BL	163	Available in black only

BCSS2BL

Communication Box

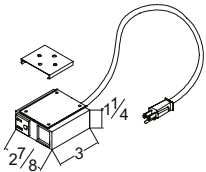

- Communication box to be installed under surface;
- 1 electrical outlet and 1 empty telecommunication outlet (outlet not included);
- 72" power cable with electric plug;
- 15A/125V;
- 1 set of universal adapters.



Code	\$	Description
BCSS2BL	163	Available in black only

BCSS3BL

Communication Box

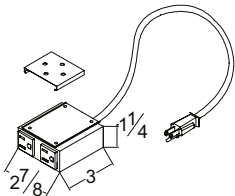

- Communication box to be installed under surface;
- 2 electrical outlets;
- 72" power cable with electric plug;
- 15A/125V;
- 1 set of universal adapters.



Code	\$	Description
BCSS3BL	163	Available in black only

POR 01

RJ45, CAT 6 connectivity port

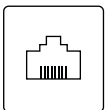

- RJ45, CAT6 connector;
- RJ45 M/F cable - 72" ;
- Finish: Black.

Code	\$	Description
POR 01	142	

POR 02

RJ11 connectivity port

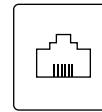

- RJ11 connector, 4 pin
- RJ11 M/F cable - 84";
- Finish: Black.

Code	\$	Description
POR 02	42	

POR 03

USB connectivity port

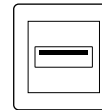

- 1 USB (data/passive);
- USB M/F cable - 72";
- Finish: Black.

Code	\$	Description
POR 03	88	

POR 04

HDMI connectivity port



- HDMI connector;
- HDMI F/F cable - 18";
- Finish: Black.

Code	\$	Description
POR 04	130	

POR 05

Mini Stereo Jack

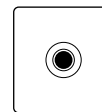

- 3.5 mm Mini Stereo Jack, M/F;
- Audio M/F cable -120";
- Finish: Black.

Code	\$	Description
POR 05	47	

POR 06

VGA Connector

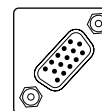

- VGA connector, 15 pin;
- VGA M/F cable -120";
- Finish: Black.

Code	\$	Description
POR 06	164	

Accessories

Electrical Accessories

F-714

Power bar

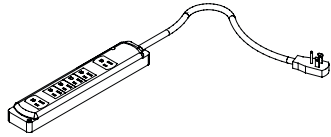

- Power bar with 6 AC 15 Amp electric outlets;
- 120", 14-3 power cable with electric plug.



Code	\$	Description
F-714	118	

PBL

Power bar

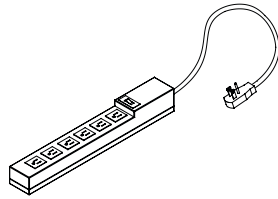

- Power bar with 6 electric outlets;
- 120" power cable with electric plug.



Code	\$	Description
PBL	61	

CT

Metal cable tray

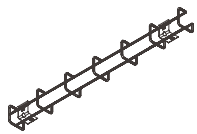

Metal cable tray

- In stainless steel;
- Dimensions: 2x4; Interior dimensions: 1-7/8"D x 1-7/8"H
- Length of 24" and 118" (118" can be cut on site).
- With mounting hardware

Code	\$	Description
CT24	53	
CT118	104	

DSG

Double-sided grommet



Double-sided grommet

- Hole diameter: 2.5"
- Use for electrical cable management with division panels. Drilling to be done by the installer.
- Grommet to cut on site for desired thickness to cover;
- *Can not be cut with a simple utility knife, use a sharper and safer tool.*

Code	\$	Description
DSG BL	23	Black
DSG WH	23	White

WMP

Wire Management Pole

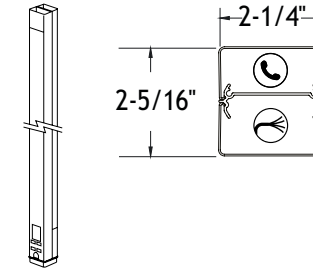

- Blank steel pole to bring cables from the ceiling to a work station;
- Satin nickel finish with a grey boot base;
- 2 compartments: 1 power/1 communications
- Mounting hardware, entrance end plate and ceiling trim plate included;
- Wires and outlets not included;
- Height: 12' 5".

Code	\$	Description
WMP	449	

As our product line is constantly evolving and expanding, we recommend that you visit logiflex.ca for updates.

logiflex

1235 St-Roch N., Sherbrooke QC J1N 0H2 Canada
T : 1.877.864.9323 | F : 1.800.474.7830 | logiflex.ca