

SEATING

Price List
USA 2023



logiflex

Table of Contents

Introduction	3	Modular Seating	23	Chairs	91
Update Summary	4	SIT - Bench	24	Madrid	92
Product Map	5	SIT - Corner Bench	26	STACK6	99
Our social responsibility	8	SIT - Occasional Tables	27	Cart	100
Conditions of Sale	8	Infiniti	36	Sedia - Chairs	101
How to Use the Price List	9	Clara	51	Milan Bold	103
Appendix A: Colors and Finishes	10	Leo	55	Milan	104
Appendix B: Upholstery Specification	12				
Appendix C : SIT	14	Soft Seating	61	Task Chairs	108
Appendix D : Kick plate Colors	15	Alpha	62	Cyrus	109
Appendix E : Wood Color Selection	15	Bulexi	65	Texto	113
Appendix F : Backs/Seats Options for Chairs	16	Dean	68	Texto Mesh	124
Appendix G : Base Options for Chairs	17	Flint	71	Texto Lab	130
Appendix H : Mechanism Options for Chairs	18	Magog	74	Elie	140
Appendix I : Chairs Options	19	Orford	75		
Appendix J : Arms Options for Chairs	20	Stelli	76	Accessories	145
Appendix K : Legs Chairs Options	22	Taylor	80	SIT - Electrical Accessories	146
		Slim	83		

Update Summary

The Seating price list presents these principal modifications:

DATE	SECTION	MODIFICATIONS
February 1, 2023	All the Price List	<ul style="list-style-type: none"> All prices have been increased by approximately 5%. Removal of Alpha, Amigo, Axis and Suavo chairs. Addition of Elie, Texto, Texto Lab and Texto Mesh chairs. Addition of cart XO-10. Modification of Madrid, Stack6 and Cyrus chairs. New certification Indoor Advantage Gold (replace Greenguard).

Previous updates:

DATE	SECTION	MODIFICATIONS
July 1, 2022	All the Price List	<ul style="list-style-type: none"> All prices have been increased by approximately 5%.
	Appendix A	<ul style="list-style-type: none"> Color availability chart update for the HPL.
February 1, 2022	All the Price List	<ul style="list-style-type: none"> All prices have been increased by approximately 6%.
	Chairs	<ul style="list-style-type: none"> Price adjustment for the Cyrus chair 500EA5AB & 500EA5SB. Addition of the black metal for Madrid chair.
	Modular Seating	<ul style="list-style-type: none"> Modification of the dimensions for Infiniti BA26, BADI26 & BADE26
	Conditions of Sales	<ul style="list-style-type: none"> The order modification / cancellation deadline is changed to 48 hours.
October 1, 2021	Appendix A	<ul style="list-style-type: none"> Color availability chart update.
July 1, 2021	All the Price List	<ul style="list-style-type: none"> All prices have been increased by approximately 6%.
May 27, 2021	Chairs	<ul style="list-style-type: none"> Addition of the Stackable Chair STACK6.

Introduction

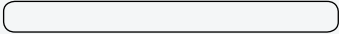

Product Map

Modular Seating

SIT - Bench	p. 24
-------------	-------

SIT - Occasional Tables	p. 27
-------------------------	-------

Fillers	p. 35
---------	-------

Electrical Accessories	p. 146
------------------------	--------

Infiniti	p. 36
----------	-------

Clara	p. 51
-------	-------

Leo	p. 55
-----	-------

Introduction



Product Map

Armchairs

Alpha p. 62

Bulexi p. 65

Dean p. 68

Flint p. 71

Magog p. 74

Orford p. 75

Stelli p. 76

Taylor p. 80

Slim p. 83

Introduction

Product Map

Chairs

Madrid p. 92



STACK6 p. 99

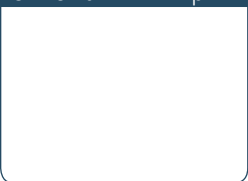

Cart p. 100



Sedia p. 101

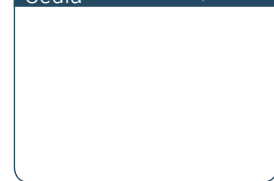

Milan Bold p. 103

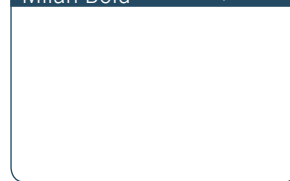

Milan p. 104



Task Chairs

Cyrus p. 109



Texto p. 113



Texto Mesh p. 124



Texto Lab p. 130



Elie p. 140



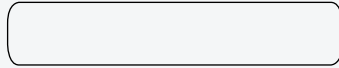

Our social responsibility

At Logiflex, we have chosen to be a responsible North American manufacturer by implementing initiatives for sustainable development. As much as possible, we source local materials and partner with suppliers who prioritize clean manufacturing processes. We also consolidate goods during transport to reduce our fuel consumption and we continually make changes that help reduce our waste production.

The company is ISO 9001 certified.

You can consult our eco-responsible approach as well as all our certifications in the [Certifications](#) section of our website. Find out how our products can help you obtain LEED credits and the Logiflex products that are Indoor Advantage Gold certified.

Conditions of Sale

Prices

The amounts listed in this document are suggested retail prices and may be changed without notice. Applicable taxes are not included. If you have an open and active account with Logiflex, merchandise will be invoiced at the prices prevailing at the time of shipment. A deposit may be requested if the opening of your account has not been completed or if your account has become inactive.

Terms of Payment

Net 30 days F.O.B. Sherbrooke, Quebec. The invoice will be assigned the shipping date and is payable 30 days from that date. Logiflex remains the owner of the merchandise until the invoice is paid in full.

Customized Products (Special Items)

Price requests for customized products or special items can be submitted via the ["Private Space"](#) section of our website, at www.logiflex.ca. Our quotations department will study your request and send you a quotation and a technical drawing for approval as soon as possible. Modifications to quotations or technical drawings can be requested the same way. The approved quotation(s) and technical drawing(s) can then be attached to your purchase order.

Orders

An official purchase order must be issued for all purchases. Your

purchase order must contain the following information:

- Your company letterhead
- Your reference number
- The delivery address (with contact name, email and phone number)
- The complete product codes
- Furniture colour(s)
- Quantities
- Descriptions
- Retail prices and net prices
- Project registration number (if applicable), and your approved quotation and technical drawing (for special items).

Please note that a quotation cannot serve as a purchase order.

Returns

All returns must first be approved by Logiflex. If the return is accepted, a Logiflex customer service representative will send you an official return authorization form in order to facilitate procedures between you, the carrier, and the Logiflex merchandise reception clerk. Additional costs for shipping or other expenses may be applied following any merchandise returns.

Modifications and/or Cancellations

You have 48 hours from the time we acknowledge receipt of your order to make any requests for corrections or modifications. You may cancel your order during this same 48-hour period. If you would like to modify or cancel your order after this 48-hour verification period, please check with a Logiflex customer service representative. Orders cannot be changed or cancelled if production has already begun or if Logiflex has already received the raw materials.

Liability

Logiflex's liability ends once the carrier has delivered all items in good condition. A delivery receipt signed by the customer acknowledges that the shipment is complete and has been received in good condition.

Claims

Logiflex recommends inspecting the shipment before signing the carrier's delivery receipt. You must notify Logiflex of any incomplete shipments or damaged furniture within 30 days after delivery. Requests to replace damaged products can be made via the ["Private Space"](#) section of our website, at www.logiflex.ca. Our after-sales service department will examine your request and help you correct the situation.

Changes

Logiflex reserves the right to make changes to the materials, accessories, components, specifications and designs, and to discontinue collections and/or models, at any time and without prior notice.

Storage and/or Shipping Fees

According to the terms Logiflex set forth in the transport policy. The transport policy can be consulted online in the Private Space.

Items Delivered Disassembled

Madrid chairs are delivered disassembled.

Warranty

Logiflex guarantees to the original purchaser that Logiflex products are free from defects in design, materials and workmanship for the product's lifetime, with certain exceptions.

You may consult the full warranty on the website:

[Logiflex Warranty](#)

Introduction

How to Use the Price List

Interactive Menu

Product line → SIT - Bench
 Product group → Modular Seating
 Product name → SIT - Corner Bench with Back
 Product code → CBD CBM CBH

Product Information

Corner bench with short back Corner bench with medium back Corner bench with high back

Combination of Colors

Bench Back Kick Plate

Options

Connectivity **Connectivity Position**

MH3C MH3D LR

How to Order

SIT		Combination of Colors		Finishes		Fabric	
series	code	connectivity	position	kick plate	supplier	pattern	color
Example	SIT	CBD	MH3C	L	W	ENNIS	LOFT AQUA

Manufacturing Standards

- Lacquered Russian plywood kick plate;
- 1" laminate construction;
- Firm density antibacterial foam;
- Single row of top stitching.

Kick Plate: Offered in the following 4 colors: Polar White, Mink Grey, Slate and Jet Black.

Dimensions:

Code	Total width	Total depth	Total height
CBD	26.75"	26.75"	29"
CBM	26.75"	26.75"	36"
CBH	26.75"	26.75"	48"

Number of yards for COM fabric:

Code	One fabric only	Combination of fabrics
CBD	4.5	2 2.75
CBM	5.25	2 3
CBH	6.25	2 4.5

Prices

Code	COM	GR1	GR2	GR3	GR4	GR5	GR6
CBD	****	****	****	****	****	****	****
CBM	****	****	****	****	****	****	****
CBH	****	****	****	****	****	****	****

Standard Product Code
Details as per the price listed

Options, if desired (\$)
Always after the product code

Combination of Colors
Laminate finishes and fabric choices

Introduction



Appendix A: Colors and Finishes

How to specify your laminate colors

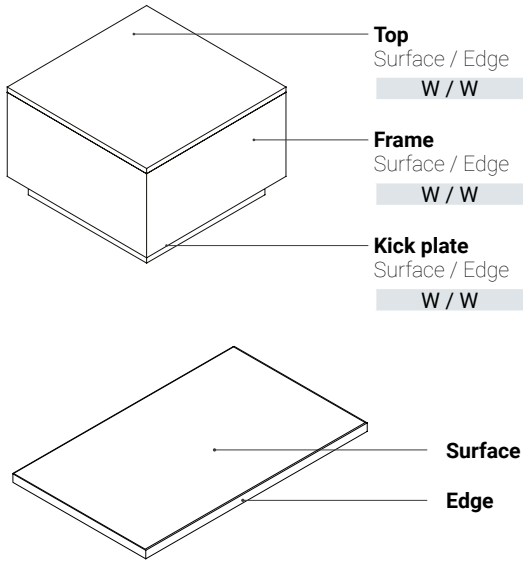

The edge is always the same color as the laminate surface color.

SIT Stretching Upholstery

To know which fabrics have been approved to be used in the SIT collection, refer to our [Upholstery Guide](#).

Availability Chart

FINI FINISH	CODE	COLOR COULEUR	THICKNESS ÉPAISSEUR			HPL	PANVAL CODE
			5/8"	1"	1-5/8"		
OMNIA	DOO	Dosha	•	•		•	K77
	COO	Cosmos	•	•		•	K78
AURA	GIA	Ginger Root Gingembre	•	•		•	H72
	HAA	Haze Brume	•	•	•	•	H57
	OHA	Ohm	•	•	•	•	K69
	STA	Storm Tempête	•	•	•	•	H58
	TUA	Tundra	•	•		•	H75
LYRA	ASY	Asha	•	•		•	K47
	CIY	Chiffon Mousseline **	•	•	•	•	K60
	KAY	Kali	•	•		•	K46
SUPERMAT	IGS	Ingot grey Gris lingot	•	•			828
	WGS	Willow grey Gris saule	•	•			802
DOLOMITE	AU	Audacity Audace **	•	•	•	•	241
	B	Jet Black Noir intense *	•	•		•	888 S405-CA
	BC	Brown cherry Cerisier brun	•	•	•	•	207
	C	Slate Ardoise *	•	•		•	801
	DR	Driftwood Bois de rive	•	•		•	744
	G	Mink Grey Gris vison	•	•		•	805 OU-927
	NM	Natural Maple Érable naturel	•	•	•	•	206
	PO	Porto	•	•		•	913 OU-648
	SW	Smoked Walnut Noyer fumé	•	•	•	•	G21
	TO	Tobacco	•	•		•	205
	W	Polar White Blanc polaire	•	•	•	•	555 459-CA
	WK	Whisky	•	•	•	•	245
	HIGH GLOSS SUPER LUSTRE	W-H	Polar White - fronts Blanc polaire - façades	•			

* Non recommended color for work surfaces.

** For conference tables with 2 or more parts, we do not recommend the use of colors with irregular and contrasted woodgrain like Chiffon, Audacity or Coastal Pear as it results in a pronounced wood grain mismatch.

Colors may vary from 2% to 5% between tfl and hpl laminates due to different technical applications.

See our complete [Colors & Finishes Guide](#)

New



Appendix A: Colors and Finishes

12 Wood Stains

Logiflex offers varnish and stain selection among the following 12 colors on all wood applications. The selection available may vary depending on the collections: please refer to the product pages for the selection available by collection. For example, the wooden Madrid chair is only available in Golden Wheat.

Knots and color variation can occur between different wood components of the same piece of furniture, or between different pieces of furniture. This variation is due to the natural characteristics of the wood, and is more contrasting for pale wood colors like Golden Wheat.



WW White Wash



GW Golden Wheat



SD Sand



AT Apricot



PN Pecan



BR Brandy



CT Chestnut



CF Coffee



ES Espresso



BO Bordeaux



BW Black Wash



BK Bark

Introduction



Appendix B: Upholstery Specification

Logiflex offers two options for upholstery specification:

Option 1 :	Customers may specify an upholstery from any supplier. Logiflex will then confirm upholstery grade and seat cost.
Option 2 :	Customers may select and purchase upholstery of their choice and ship upholstery to Logiflex (COM)

Option 1 : Specified Upholstery

Customers may consult the websites of our principal suppliers to visualize their complete product range. It is then possible to consult the graded-in list available on Logiflex.ca to be informed of the appropriate Logiflex grade.

Website of the upholstery supplier gives essential information to the maintenance, availability, quality and performance of the selected upholstery. In all cases, the upholstery supplier's warranty will apply.

Information to provide with the order:

Customer name
Purchase order number
Upholstery supplier name
Pattern name/number
Color name/number
Number of yards to order

Principal suppliers:

Momentum Textiles	themomgroup.com
Ennis Fabrics	ennisfabrics.com
Maharam	maharam.com
Designtex	designtex
Mayer Fabrics	mayerfabrics.com

See our Graded-In Program at:

logiflex.ca/medias/documents/logiflex-graded-in.pdf

Graded-in List:

Seat cost depends of selected upholstery. Grade is not established according to upholstery quality or performance, but to its purchase cost. In order to help customers researches, a graded-in list presenting the entire collections of Logiflex's principal suppliers has been prepared. It is possible to consult Logiflex graded-in list by visiting logiflex.ca

Note: The graded-in list is based on information at time of the publication of this document. As upholstery suppliers can discontinue products or increase their prices at their discretion, this list communicated for information purposes only and can not be considered as a sale commitment by Logiflex.

Option 2 : Customer's Own Material (COM)

Logiflex offers the option of providing your own upholstery. The price will be based on the cushion grade 2.

Orders with a COM fabric must be written clearly and indicate the color, pattern, width of the fabric and the manufacturer or distributor. The customer is responsible for providing a 12" x 12" sample to Logiflex for approval of the upholstery. Furthermore, Logiflex reserves the right to refuse any upholstery that does not meet Logiflex selection criteria.

COM fabrics must be delivered to the Logiflex factory with freight and duties paid. For COM orders, the order's delivery date is set once the fabric is received by Logiflex. All charges to COM acquisition on the customer's behalf will be passed onto the customer.

Logiflex does not assume responsibility for upholstery availability, quality, performance or appearance. In addition, the Logiflex warranty excludes customer's own materials.

COM upholstery delivery:

The following information must be included with the COM upholstery delivery and be communicated to the account manager along with the purchase order:

Customer name
Purchase order number
Upholstery supplier name
Pattern name/number
Color name/number
Number of yards delivered

Shipping address:

Logiflex
Attn: Receiver
1235 St-Roch North Road
Sherbrooke Quebec
Canada J1N 0H2

Note: A late reception of fabric may cause delivery delays.

Upholstery Quantities:

The quantities of fabric yardage to order for each piece of furniture is indicated in the "Manufacturing Standard" section on the product page indicating the amount of yards required.

Where this option is available, you will see the following table in the "Manufacturing Standard" section on the product page indicating the amount of yards required:

Example:

Number of yards for COM fabric:

Code	Total	Back	Seat	Frame
BD	3.25	1.25	2	1.25
BM	3.5	1.75	2	1.25
BH	4	2.25	2	1.25

Note: It is recommend that you include a layout with all orders and that you choose a solid fabric color for the seat portion.



Appendix B: Upholstery Specification *(continued)*

Seams

Different top stitchings are available for different armchair models.

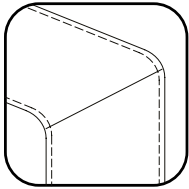

PQS

Single Top Stitch

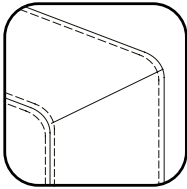

PQD

Double Top
Stitch

Combining Fabrics

Different fabrics can be specified for the bench and back of the same seat at no extra cost.

Where this option is available, you will see the **Combination of Colors** indicator illustrations.

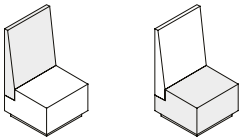

Example:

Backrest: ENNIS / BALANCE / #9009 GR1

Seat: ENNIS / ORNAMENTAL / #302 GR3

The price will be that of the highest-grade fabric chosen.

Application of Upholstery

Application of upholstery will follow the directional orientation of its pattern. Explicit instructions must be given to the customer's account manager if a specific direction is desired. Logiflex will not be responsible of problems related to upholstery direction or positioning unless formal instructions has been given along with the purchase order.

Instruction references:

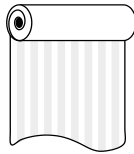

Up the Roll

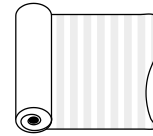

Railroaded
(across the roll)

Leather

All leathers used are "cowhide".

Please note that the warranty does not apply on leather's natural imperfections, such as: scars, marks, and difference in stain within a leather skin or different skins. This specification also applies for standard leather GR5 and Italian leather GR7 and up.

Polyurethane foam

The polyurethane foam used in the manufacturing of our armchairs is antibacterial.

Different densities exist and will vary from one armchair model to the other. Medium-density foam is used for back and seating parts, while the firmer-density foam is used for armrest parts.

CAL 117 Flammability standards

The foam used meets or exceeds the flammability standards of the California Technical Bulletin 117 norms.

CAL 133 Flammability standards

It is possible to order chairs or soft seating that comply with the technical bulletin California 133 (CAL 133) used primarily in public buildings without sprinkler systems. In order to be compliant, the fabrics must be certified CAL 117 and a fire blocking material, which prevents fire from spreading, must be installed under the fabric by Logiflex.

To obtain a certificate from an independent laboratory, you must pay the price of the compliant product to be tested plus a cost to cover the transportation, testing and the issuing of the certificate

Customers interested in ordering a CAL 133 compliant product are encouraged to contact customer service for pricing and instructions.

Introduction



Appendix C : SIT

Manufacturing Standards

Levelers

All modules with a kick plate sit on white nylon levelers.

Fasteners

All modules with a kick plate come with 2 fasteners to join to other modules.

Dimensions

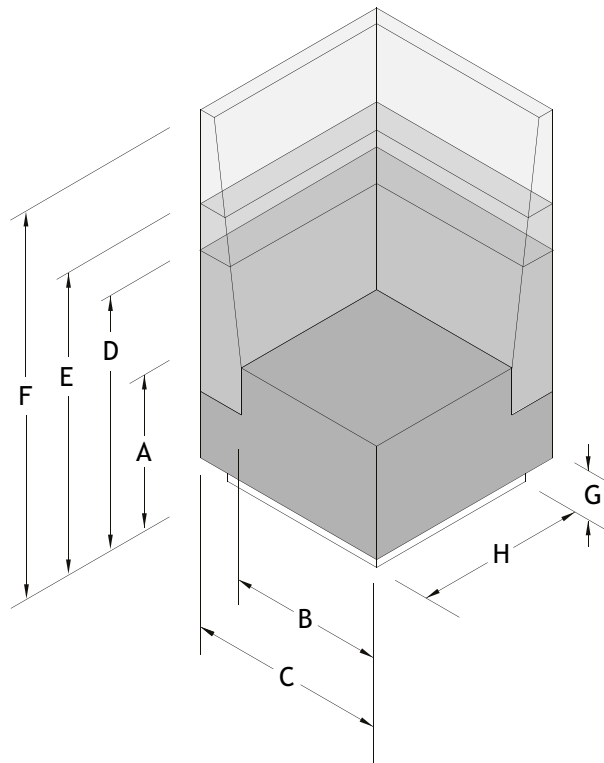

A. Bench height	18" *
B. Bench depth to back	20-3/4" *
C. Bench depth to panel	26-3/4" *
D. Short back height	29"
E. Medium back height	36"
F. High back height	48"
G. Kick plate height (Angle of back 8°)	3-1/2"
H. Kick plate width	22"

* Dimensions may vary depending on selected fabric thickness.

Wiring Management

All kick plates include a half-round machine-cut on all four sides for feeding cables from one module to the next.

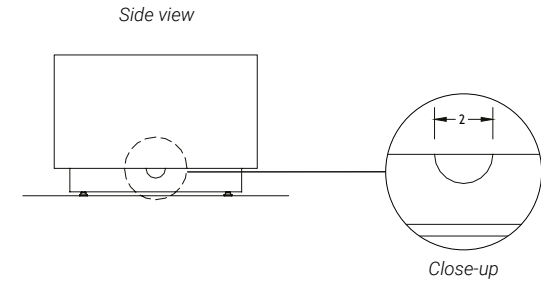

Installation example

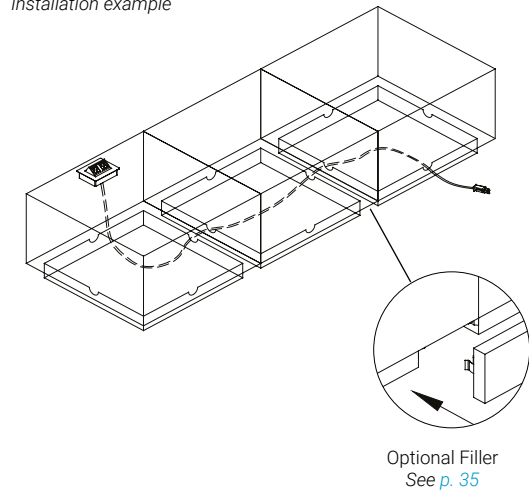

Introduction



Appendix C : SIT

MH3 - Connectivity - positions

Benches and tables

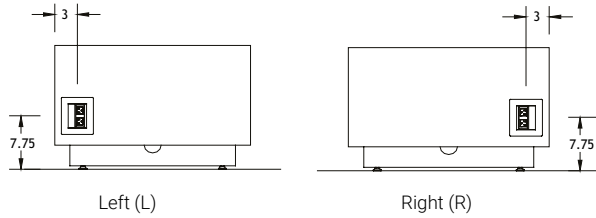

Benches with notch(es)

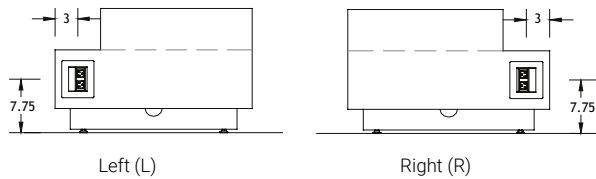
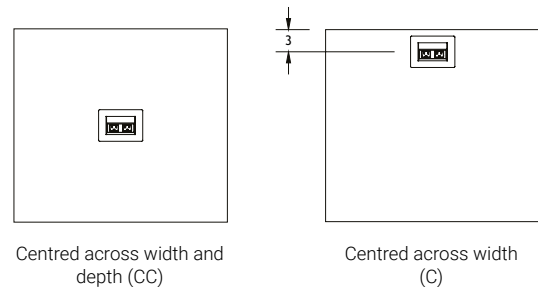
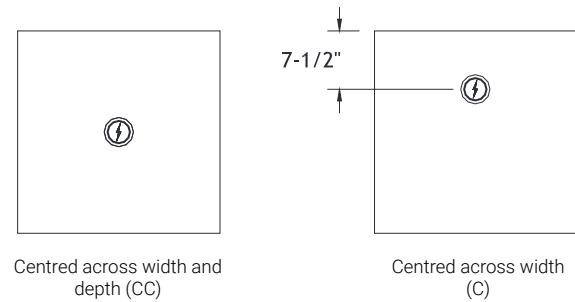

Table tops



Qi - Connectivity - positions



Appendix D : Kick plate Colors

Logiflex offers a selection among the following colors for the SIT collection kick plates:



Appendix E : Wood Color Selection

Logiflex offers varnish and stain selection among the following colors:

- GW** Golden Wheat
- WW** White Wash
- CT** Chestnut
- ES** Espresso
- AT** Apricot
- BW** Black Wash
- PN** Pecan
- CF** Coffee
- BR** Brandy
- BK** Bark
- SD** Sand
- BO** Bordeaux

* Madrid chairs are only available in Golden Wheat (GW)



Appendix F : Backs/Seats Options for Chairs

Seat Width

Available for chairs:

Width	Cyrus	Texto	Texto Mesh	Texto Lab	Elie
Narrow seat		TX1			
Standard seat		TX2	TXM2		
Large seat		TX3	TXM3		

● Not available for chairs with stool height.



- 1 Narrow seat (-2")**
- Width seat: 17"
 - Width backrest: 16 1/2"
 - Depth seat: 17"



- 2 Standard seat**
- Width seat: 19"
 - Width backrest: 18 1/2"
 - Depth seat: 18"

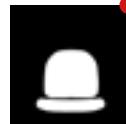

- 3 Large seat (+2")**
- Width seat: 21"
 - Width backrest: 18 1/2"
 - Depth seat: 18"
 - "Heavy duty" type cylinder with a thrust of 450 Newton.
 - Reinforced fixing of the backrest bar to the structure.
- \$145

Back Height

Available for chairs:

Height	Cyrus	Texto	Texto Mesh	Texto Lab	Elie
L - Low		o		o	
M - Medium		o			o
D - Director		o			
H - High		o			o
T - T Shaped back				o	
C - Contour back				o	
X - No back				o	

*For backrest heights, see product pages



L Low back



M Medium back



D Director back



H High back with headrest



T T shaped back



C Contour back



X No back



Appendix G : Base Options for Chairs

Chairs Options

Available for chairs:

Code	Cyrus	Texto	Texto Mesh	Texto Lab	Elie
VN	<input type="radio"/>	<input type="radio"/>	<input type="radio"/>		<input type="radio"/>
ZN	<input type="radio"/>	<input type="radio"/>	<input type="radio"/>	<input type="radio"/>	<input type="radio"/>
VC	<input type="radio"/>	<input type="radio"/>	<input type="radio"/>		<input type="radio"/>
ZC	<input type="radio"/>	<input type="radio"/>	<input type="radio"/>	<input type="radio"/>	<input type="radio"/>
TN		<input type="radio"/>	<input type="radio"/>	<input type="radio"/>	
TC		<input type="radio"/>	<input type="radio"/>	<input type="radio"/>	
01	<input type="radio"/>	<input type="radio"/>	<input type="radio"/>		<input type="radio"/>



VN Black nylon tapered base
 • 27" diameter



ZN Black nylon rounded base
 • 27" diameter



VC Aluminum tapered base
 • 27" diameter
 \$160



ZC Aluminum rounded base
 • 27" diameter
 \$160



TN Black nylon rounded stool base
 • 27" diameter
 • 10 5/8" cylinder
 • 60° footrest, 20" diameter
 • Height-adjustable



TC Aluminum rounded stool base
 • 27" diameter
 • 10 5/8" cylinder
 • 360° footrest, 20" diameter
 • Height-adjustable
 \$160



01 Sled base

Appendix H : Mechanism Options for Chairs

Mechanisms

Available for chairs:

Code	Cyrus	Texto	Texto Mesh	Texto Lab	Elie
10		o	o		o
11		o	o	o	o
20		o	o		o
21		o	o		o
31		o	o	o	o
41	o	o	o		o
51		o	o	o	o
71		o	o		
76F		o			

* Mechanisms 31 and 51 for stools: the tilt function is not included for safety reasons. Only the mechanism 51 allows adjustment of the seat angle.



Mechanism 10

- Adjustable height (screw)
- 360° swivel on column axis



Mechanism 11 13

- Adjustable height (gas cylinder)
- 360° swivel on column axis



Mechanism 31

- Adjustable height (gas cylinder)
- 360° swivel on column axis
- Backward tilt from 3° to 18° (center pivot)
- Adjustable tilt tension
- Tilt lock to one position, at 3°
- Adjustable angle on back from 86° to 121°

\$28



Mechanism 41

- Adjustable height (gas cylinder)
- 360° swivel on column axis
- Synchro tilt of seat from -1° to 10° (center pivot) and of back from 90° to 110°
- Adjustable tilt tension
- Tilt lock in 5 positions

\$55



Mechanism 20

- Adjustable height (screw)
- 360° swivel on column axis
- Tilt lock to one position, at 3°

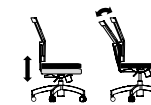

Mechanism 21

- Adjustable height (gas cylinder)
- 360° swivel on column axis
- Tilt lock to one position, at 3°
- Backward tilt from 3° to 20° (center pivot)



Mechanism 51

- Adjustable height (gas cylinder)
- 360° swivel on column axis
- Backward tilt from 3° to 17° (center pivot)
- Adjustable tilt tension
- Tilt lock in all positions
- Adjustable backrest angle from 80° to 108°

\$55



Mechanism 71

- 360° swivel on column axis.
- Adjustable height (gas cylinder)
- 20° backward tilt starting from initial position adjustable between -4° to 5°
- Adjustable tilt tension
- Tilt lock in all positions
- Adjustable backrest angle from 89° to 105°

\$116



Mechanism 76F

- Adjustable height (gas cylinder)
- 360° swivel on column axis
- 20° backward tilt starting from initial position adjustable between -4° to 5°
- Adjustable tilt tension
- Tilt lock in all positions
- Adjustable backrest angle from 89° to 105°
- Adjustable depthseat of 2-1/2"
- Adjustable backrest of 4"

\$163



Appendix I : Chairs Options

Options

Available for chairs:

Code	Cyrus	Texto	Texto Mesh	Texto Lab	Elie
R		o	o	o	
S		o	o		o
F		o			

R Back height adjustment option

This option allows a backrest adjustment of 3". The option is available on certain mechanisms only, add "R" after the mechanism code (ex. mechanism #21 becomes #21R).

\$33

S Seat sliding option

This option allows a front-to-back sliding seat adjustment of 2 ½", to adjust the seat depth. The option is available on certain mechanisms only, add "S" after the mechanism code (ex. mechanism #21 becomes #21S) and add \$72. Not available on X-Large seat widths.

\$83

F Combined options

Backrest height adjustment & sliding seat. The option is available on certain mechanisms only, add "F" after the mechanism code (ex. mechanism #21 becomes #21F) and add \$99. Not available on X-Large seat widths.

\$116

Introduction

Appendix J : Arms Options for Chairs

Arms

Available for chairs:

Code	Cyrus	Texto	Texto Mesh	Texto Lab	Elie
NA	o	o	o		o
AD	o	o	o		o
AG		o	o		
AP		o	o		
AR		o	o		
AS	o	o	o		o
AW		o	o		
AX		o	o		
AY		o	o		
AZ	o	o	o		o
FD	o	o	o		o
FG	o	o	o		o
FT		o	o		o
FZ	o	o	o		o
F7	o				
F61	o				

No Arm



- NA**
- No arm

Adjustable Arms



AG \$138



AP \$138



AR \$138

Adjustable arms

- Black nylon arm, steel attachment with urethane armrest.
- Medium firmness (3/5).
- Height adjustment of 3" using a lever.
- 3" width adjustment.



AD \$138

Adjustable arms

- Black nylon arm, steel attachment with urethane armrest.
- Medium firmness (3/5).
- Height adjustment of 3" using a lever.



AX \$220

Adjustable arms with multi-axis armrests

- Black nylon arm, steel attachment with urethane armrest.
- Medium firmness (3/5).
- Height adjustment of 3" using a lever.
- 3" width adjustment.



AS \$138

Adjustable arms

- Black nylon arm, steel attachment with urethane armrest.
- Medium firmness (3/5).
- Height adjustment of 3" using a push button.



AY \$220

Adjustable arms with multi-axis and pivot armrests

- Black nylon arm, steel attachment with urethane armrest.
- Medium firmness (3/5).
- Height adjustment of 3" using a lever.
- Lateral and front-to-back armrest adjustment.
- Pivot of -30° to +30°.
- 3" width adjustment on certain models.



AW \$138

Adjustable arms with pivot

- Black nylon arm, steel attachment with urethane armrest.
- Medium firmness (3/5).
- Height adjustment of 3" using a lever.
- Pivot of -30° to +30°.
- 3" width adjustment.



AZ \$281

Adjustable arms with multi-axis and pivot armrests

- Black nylon arm, polished aluminum attachment with urethane armrest.
- Medium firmness (3/5).
- Height adjustment of 2 3/4" using a push button.
- Pivot of -30° to +30°.
- Front/back adjustment of 2".



Appendix J : Arms Options for Chairs

Fixed Arms



FD \$138



FG \$138

Open/Closed fixed arms

- Reinforced steel frame covered in urethane.
- Medium firmness (4/5).
- 3" width adjustment on certain models.



FT \$138

Open curved fixed arms

- Reinforced steel frame covered in urethane.
- Medium firmness (3/5).
- 3" width adjustment on certain models



FZ \$281

Fixed arms

- Polished aluminum frame arm.
- Medium firmness (4/5).
- Armrest upholstered with the same fabric as the chair.
- Not adjustable.



F7 \$281

Fixed aluminum arms

- Black polyurethane cover



F61 \$138

Fixed T shaped arm

- Black polyurethane pad



Appendix K : Legs Chairs Options

Legs

Available for chairs:

Code	Cyrus	Texto	Texto Mesh	Texto Lab	Elie	Madrid
H	o	o	o	o	o	
S	o	o	o	o	o	
G	o	o	o	o	o	
M		o	o	o		
T						o



H Casters for carpeting

- Lightly textured black nylon.
- 2" diameter with double drum.
- For VN and VC bases, the caster has a 2 3/8" diameter.



M Mixed (3 casters, 2 glides)

- For 5-prong bases for stools (TN, TC and TB), a mixed option can be specified: 3 "H" casters and 2 "G" glides will be installed on the base.



S Casters for hard surfaces

- Lightly textured black nylon.
- 2" diameter with double drum.
- The center of the caster is nylon covered in ultra-soft urethane for a smoother rolling motion.
- For VN and VC bases, the caster has a 2 3/8" diameter



T Teflon glides



G Nylon glides

- Lightly textured black nylon.
- 2" high.
- On VN and VC bases, the glide is 2 3/8" high.

Modular Seating

SIT - Bench

B

Bench with kick plate

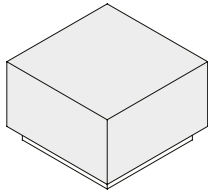

BC

Bench with ball casters

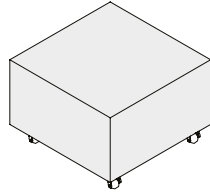

Manufacturing Standards

- **B**: Lacquered Russian plywood kick plate;
- **BC**: 4 Ball casters with breaks;
- 1" laminate construction;
- Firm density antibacterial foam;
- Single row of top stitching.

Note: MH3 are not available on the bench with ball casters.

Kick Plate: Offered in the following 4 colors: Polar White, Mink Grey, Slate and Jet Black.

Dimensions:

Code	Total width	Total depth	Total height
B	26.25"	26.25"	18"
BC	26.25"	26.25"	18"

Number of yards for COM fabric:

Code	Total	Seat	Frame
B	1.75	.75	1.25
BC	1.75	.75	1.25

Note: It is recommend that you include a layout with all orders.

Combination of Colors

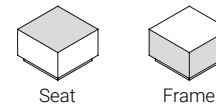

Options

Connectivity



\$401 \$401

Connectivity Position

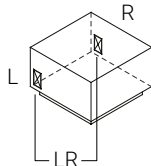

Prices

Code	GRA	GR1	COM GR2	GR3	GR4	GR5	GR6	GR7	GR8	GR9	GR10	GR11	GR12	Cuir Leather
B	1055	1084	1123	1161	1209	1257	1305	1354	1402	1450	1498	1594	1690	1610
BC	1022	1051	1090	1128	1176	1224	1272	1321	1369	1417	1465	1561	1657	1577

How to Order

SIT	B BC	MH3C MH3D	L R LR	Combination of Colors				
				Finishes	Fabric <i>See the Logiflex Graded-in List</i>			
series	code	connectivity	position	kick plate	supplier	pattern	color	
Example	SIT	B	MH3C	L	W	ENNIS	LOFT	AQUA

Modular Seating

SIT - Bench with Back

BD

Bench with short back

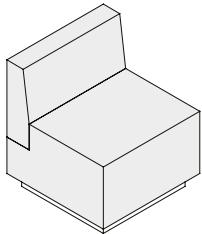

BM

Bench with medium back

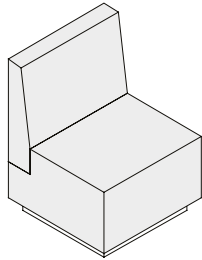

BH

Bench with high back

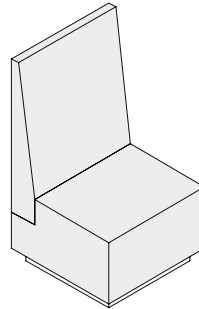

Manufacturing Standards

- Lacquered Russian plywood kick plate;
- 1" laminate construction;
- Firm density antibacterial foam;
- Single row of top stitching.

Kick Plate: Offered in the following 4 colors: Polar White, Mink Grey, Slate and Jet Black.

Dimensions:

Code	Total width	Total depth	Total height
BD	26.25"	26.25"	29"
BM	26.25"	26.25"	36"
BH	26.25"	26.25"	48"

Number of yards for COM fabric:

Code	Total	Back	Seat	Frame
BD	3.25	1.25	1	1.25
BM	3.5	1.75	1	1.25
BH	4	2.25	1	1.25

Note: It is recommend that you include a layout with all orders and that you choose a solid fabric color for the seat portion.

Combination of Colors

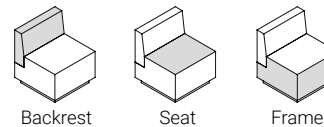

Options

Connectivity



\$401 \$401

Connectivity Position

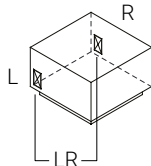

Prices

Code	GRA	GR1	COM GR2	GR3	GR4	GR5	GR6	GR7	GR8	GR9	GR10	GR11	GR12	Cuir Leather
BD	1484	1538	1610	1681	1770	1860	1949	2039	2128	2217	2307	2485	2664	2515
BM	1542	1600	1677	1754	1850	1947	2043	2139	2235	2332	2428	2620	2813	2652
BH	1637	1703	1791	1879	1989	2099	2209	2319	2429	2539	2649	2869	3089	2906

How to Order

SIT	BD BM BH	MH3C MH3D	L R LR	Combination of Colors				
				Finishes	Fabric <i>See the Logiflex Graded-in List</i>			
series	code	connectivity	position	kick plate	supplier	pattern	color	
Example	SIT	BD	MH3C	L	W	ENNIS	LOFT	AQUA

Modular Seating

SIT - Corner Bench with Back

CBD

Corner bench with short back

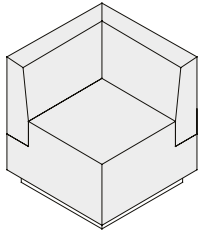

CBM

Corner bench with medium back

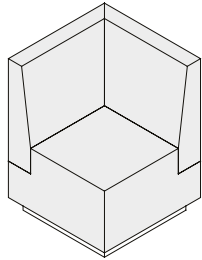

CBH

Corner bench with high back

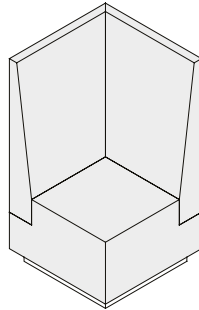

Manufacturing Standards

- Lacquered Russian plywood kick plate;
- 1" laminate construction;
- Firm density antibacterial foam;
- Single row of top stitching.

Kick Plate: Offered in the following 4 colors: Polar White, Mink Grey, Slate and Jet Black.

Dimensions:

Code	Total width	Total depth	Total height
CBD	26.25"	26.25"	29"
CBM	26.25"	26.25"	36"
CBH	26.25"	26.25"	48"

Number of yards for COM fabric:

Code	Total	Backrest	Seat	Frame
CBD	4.5	2.75	.75	1.25
CBM	5.25	3	.75	1.25
CBH	6.25	4.5	.75	1.25

Note: It is recommend that you include a layout with all orders and that you choose a solid fabric color for the seat portion.

Combination of Colors

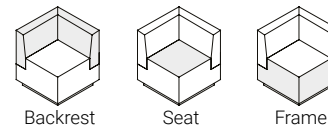

Options

Connectivity



\$401 \$401

Connectivity Position

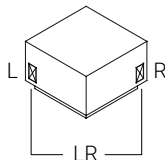

Prices

Code	GRA	GR1	COM GR2	GR3	GR4	GR5	GR6	GR7	GR8	GR9	GR10	GR11	GR12	Cuir Leather
CBD	1793	1867	1966	2065	2189	2313	2436	2560	2684	2808	2931	3179	3426	3220
CBM	2174	2261	2377	2492	2636	2781	2925	3070	3214	3358	3503	3791	4080	3840
CBH	2453	2556	2694	2831	3003	3175	3347	3519	3690	3862	4034	4378	4722	4435

How to Order



Combination of Colors

SIT	CBD CBM CBH	MH3C MH3D	L R LR	Finishes	Fabric <i>See the Logiflex Graded-in List</i>		
series	code	connectivity	position	kick plate	supplier	pattern	color

Example SIT CBD MH3C L W ENNIS LOFT AQUA

Modular Seating

SIT - Occasional Table with Laminate Frame

T

Laminate frame

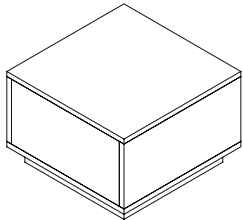

Combination of Colors

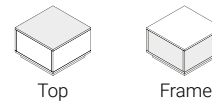

Manufacturing Standards

- 1" laminate top and frame;
- Lacquered Russian plywood kick plate;
- 1" laminate construction.

Kick Plate: Offered in the following 4 colors: Polar White, Mink Grey, Slate and Jet Black.

Dimensions:

Code	Total width	Total depth	Total height
T	26.25"	26.25"	18"

Note: It is recommend that you include a layout with all orders.

Options

Marker Board



MB
\$248

Connectivity



\$401 \$401

Connectivity Position

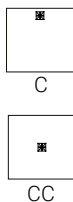
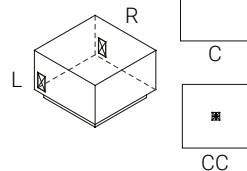

Air Charger

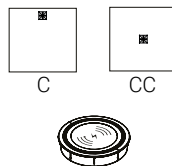

\$624

How to Order

							Combination of Colors			
							Finishes <i>See the Logiflex Color Guide</i>			
SIT	T	MB	MH3C MH3D	L R C CC	QIBL	C CC				
series	code	marker board	connectivity	position	Qi (Appx. B)	Qi position	top	frame	kick plate	
Example	SIT	T	MB	MH3C	L	QIBL	CC	W	W	W

Modular Seating

SIT - Occasional Table with Fabric Frame

FT

Fabric frame

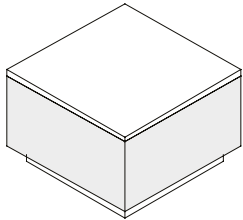

Combination of Colors

Laminate Fabric

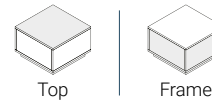

Manufacturing Standards

- 1" laminate top;
- Fabric frame
- Lacquered Russian plywood kick plate;
- 1" laminate construction.

Kick Plate: Offered in the following 4 colors: Polar White, Mink Grey, Slate and Jet Black.

Dimensions:

Code	Total width	Total depth	Total height
FT	26.25"	26.25"	18"

Number of yards for COM fabric:

Code	Total	Frame
FT	1.25	1.25

Note: It is recommend that you include a layout with all orders.

Options

Marker Board



MB
\$248

Connectivity



\$401



\$401

Connectivity Position

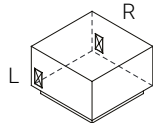

C



CC

Air Charger

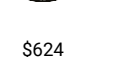
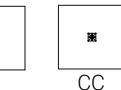

\$624

Prices

Code	GRA	GR1	COM GR2	GR3	GR4	GR5	GR6	GR7	GR8	GR9	GR10	GR11	GR12	Cuir Leather
FT	867	888	916	943	977	1012	1046	1081	1115	1149	1184	1252	1321	1264

How to Order

		Combination of Colors										
SIT	FT	MB	MH3C MH3D	L R C CC	QIBL	C CC	Finishes <i>See the Logiflex Color Guide</i>		Fabric <i>See the Logiflex Graded-in List</i>			
series	code	marker board	connectivity	position	Qi (Appx. B)	Qi position	top	kick plate	supplier	pattern	color	
Example	SIT	FT	MB	MH3C	L	QIBL	CC	W	W	ENNIS	LOFT	AQUA

Modular Seating

SIT - Bookshelf Tables with Laminate Frame

TB1

Open on 1 side

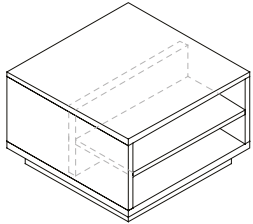

TB2

Open on 2 sides

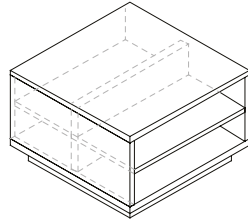

Combination of Colors

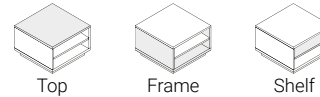

Manufacturing Standards

- 1" laminate top;
- Bookshelf with 1 fixed shelf per open side;
- Vertical central separator;
- Lacquered Russian plywood kick plate;
- 1" laminate construction.

Kick Plate: Offered in the following 4 colors: Polar White, Mink Grey, Slate and Jet Black.

Dimensions:

Code	Total width	Total depth	Total height
TB1	26.25"	26.25"	18"
TB2	26.25"	26.25"	18"

Note: It is recommend that you include a layout with all orders.

Options

Marker Board



MB
\$248

Prices

Code	Price
TB1	865
TB2	865

How to Order

		+		Combination of Colors			
				Finishes <i>See the Logiflex Color Guide</i>			
SIT	TB1 TB2	MB					
series	code	marker board	top	frame	shelf	kick plate	
Example	SIT	TB1	MB	W	W	W	W

Modular Seating

SIT - Occasional Table with Laminate Frame on Casters

TC

Laminate frame

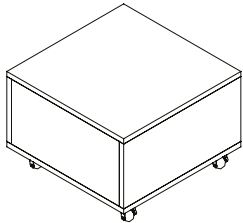

Combination of Colors

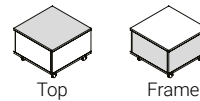

Manufacturing Standards

- 1" laminate top and frame;
- Four ball castors with breaks;
- 1" laminate construction.

Dimensions:

Code	Total width	Total depth	Total height
TC	26.25"	26.25"	18"

Note: It is recommend that you include a layout with all orders.

Options

Marker Board



MB
\$248

Prices

Code	Price
TC	763

How to Order



Combination of Colors

MB

Finishes

[See the Logiflex Color Guide](#)

SIT	TC	MB		
series	code	marker board	top	frame
Example	SIT	TC	MB	W W

Modular Seating

SIT - Occasional Table with Fabric Frame on Casters

FTC

Fabric frame

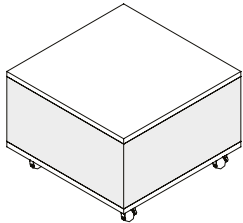

Manufacturing Standards

- 1" laminate top;
- Fabric frame
- Four ball castors with breaks;
- 1" laminate construction.

Dimensions:

Code	Total width	Total depth	Total height
FTC	26.25"	26.25"	18"

Number of yards for COM fabric:

Code	Total	Frame
FTC	1.25	1.25

Combination of Colors

Laminate | Fabric

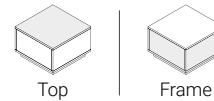

Options

Marker Board



MB
\$248

Prices

Code	GRA	GR1	COM GR2	GR3	GR4	GR5	GR6	GR7	GR8	GR9	GR10	GR11	GR12	Cuir Leather
FTC	856	877	905	932	966	1001	1035	1070	1104	1138	1173	1241	1310	1253

How to Order



Combination of Colors

Finishes
See the
Logiflex Color
Guide

Fabric
See the Logiflex Graded-in List

SIT	FTC	MB	Combination of Colors			
series	code	marker board	top	supplier	pattern	color
Example SIT	FTC	MB	W	ENNIS	LOFT	AQUA

Modular Seating

SIT - Bookshelf Tables with Laminate Frame on Casters

TBC2

Open on 2 sides

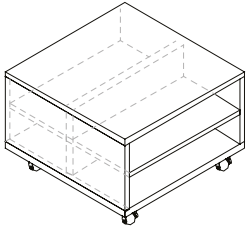

Combination of Colors

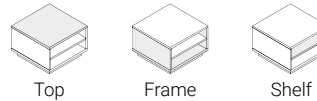

Top

Frame

Shelf

Manufacturing Standards

- 1" laminate top;
- Bookshelf with 1 fixed shelf per open side;
- Vertical central separator;
- Four ball castors with breaks;
- 1" laminate construction.

Dimensions:

Code	Total width	Total depth	Total height
TBC2	26.25"	26.25"	18"

Note: It is recommend that you include a layout with all orders.

Options

Marker Board



MB
\$248

Prices

Code	
TBC2	774

How to Order



Combination of Colors

Finishes [See the Logiflex Color Guide](#)

SIT	TBC2	MB	Combination of Colors		
series	code	marker board	top	frame	shelf
Example SIT	TBC2	MB	W	W	W

Modular Seating

SIT - Bench with Fabric Frame and Built-in Table with Laminate Frame

26BT

Laminate frame table

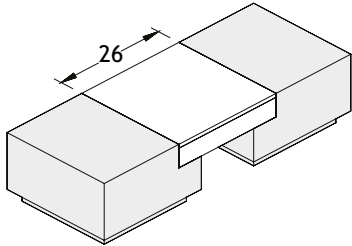

38BT

Laminate frame table

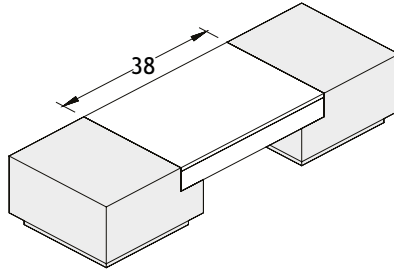

Manufacturing Standards

- 1" laminate top;
- 2 fabric benches;
- 1 built-in table with 1" 1" laminate top and frame;
- Lacquered Russian plywood kick plate;
- Firm density antibacterial foam;
- 1" laminate construction.

Kick Plate: Offered in the following 4 colors: Polar White, Mink Grey, Slate and Jet Black.

Dimensions:

Code	Largeur totale	Profondeur totale	Total height	Table length
26BT	66"	26.25"	18"	26"
38BT	78"	26.25"	18"	38"

Number of yards for COM fabric:

Code	Total	Seat	Frame
26BT	2.75	1	2.25
38BT	2.75	1	2.25

Note: It is recommend that you include a layout with all orders and that you choose a solid fabric color for the seat portion.

Combination of Colors

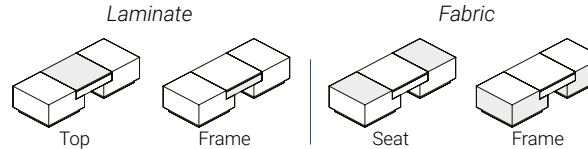

Options

Connectivity

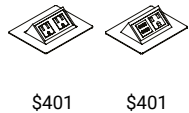

Connectivity Position

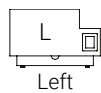

Left



C

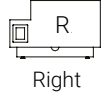

Right



CC

Air Charger

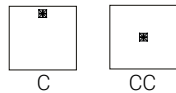

C



CC



\$624

\$

Prices

Code	GRA	GR1	COM GR2	GR3	GR4	GR5	GR6	GR7	GR8	GR9	GR10	GR11	GR12	Cuir Leather
26BT	2314	2359	2420	2480	2556	2631	2707	2783	2858	2934	3009	3161	3312	3186
38BT	2400	2445	2506	2566	2642	2717	2793	2869	2944	3020	3095	3247	3398	3272

How to Order

Combination of Colors

Finishes
See the Logiflex Color Guide

Fabric
See the Logiflex Graded-in List

SIT	26BT 38BT	MH3C MH3D	L R C CC	QIBL	C CC	top	frame	kick plate	supplier	pattern	color	
series	code	connectivity	position	Qi (Appx. B)	Qi position							
Example	SIT	26BT	MH3C	L	QIBL	CC	W	W	W	ENNIS	LOFT	AQUA

Modular Seating

SIT - Bench with Fabric Frame and Built-in Table with Fabric Frame

26BFT

Fabric frame table

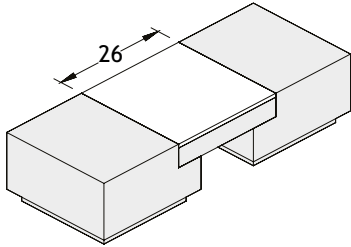

38BFT

Fabric frame table

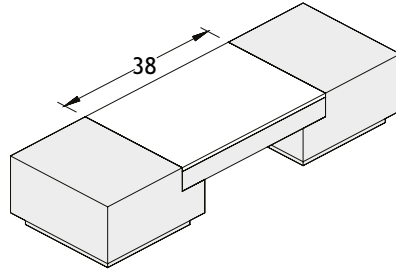

Manufacturing Standards

- 1" laminate top;
- 2 fabric benches;
- 1 built-in table with 1" laminate top and fabric frame;
- Lacquered Russian plywood kick plate;
- Firm density antibacterial foam;
- 1" laminate construction.

Kick Plate: Offered in the following 4 colors: Polar White, Mink Grey, Slate and Jet Black.

Dimensions:

Code	Largeur totale	Profondeur totale	Total height	Table length
26BFT	66"	26.25"	18"	26"
38BFT	78"	26.25"	18"	38"

Number of yards for COM fabric:

Code	Total	Seat	Frame
26BFT	3.5	1	2.5
38BFT	3.75	1	2.75

Note: It is recommend that you include a layout with all orders and that you choose a solid fabric color for the seat portion.

Combination of Colors

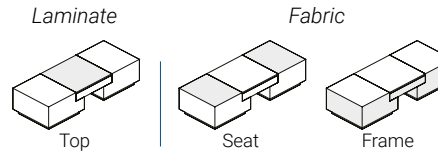

Options

Connectivity

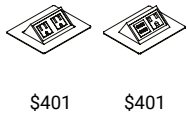

Connectivity Position

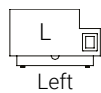

Left



Right



C



CC

Air Charger

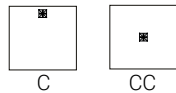

C



CC



\$624

\$

Prices

Code	GRA	GR1	COM GR2	GR3	GR4	GR5	GR6	GR7	GR8	GR9	GR10	GR11	GR12	Cuir Leather
26BFT	2714	2772	2849	2926	3022	3119	3215	3311	3407	3504	3600	3792	3985	3824
38BFT	2766	2828	2911	2993	3096	3199	3302	3406	3509	3612	3715	3921	4127	3956

How to Order

						Combination of Colors					
						Finishes		Fabric			
						See the Logiflex Color Guide		See the Logiflex Graded-in List			
SIT	26BFT 38BFT	MH3C MH3D	L R C CC	QIBL	C CC	top	kick plate	supplier	pattern	color	
series	code	connectivity	position	Qi (Appx. B)	Qi position						
Example	SIT	26BFT	MH3C	L	QIBL	CC	W	W	ENNIS	LOFT	AQUA

Modular Seating

SIT - Space Filler for Benches

FILLER4

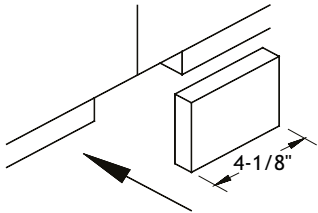

Manufacturing Standards

- 4-1/8" removable joint for junctions between kick plates;
- Lacquered Russian plywood.

Note: For best results, order 2 fillers for each module junction.

Prices

Code	
FILLER4	42

How to Order

FILLER4

code

Example **FILLER4**

Modular Seating

Infiniti - Square Bench

BC26

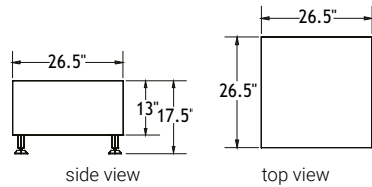
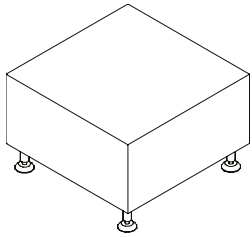

Manufacturing Standards

- 4 brushed chrome metal legs;
- Single top stitching;
- Elastic straps on seat;
- Firm density foam on seat;
- 1/2" thick polyester on the sides of the frame;
- Frame made out of plywood and hardwood..

Combination of Colors

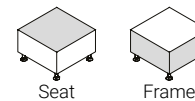

Number of yards for COM fabric:

Code	Total	Seat	Frame
BC26	2.5	.75	1.75

Note: It is recommend that you include a layout with all orders and that you choose a solid fabric color for the seat portion.



Prices

Code	GRA	GR1	COM GR2	GR3	GR4	GR5	GR6	GR7	GR8	GR9	GR10	GR11	GR12	Cuir Leather
BC26	1046	1087	1142	1197	1266	1335	1403	1472	1541	1610	1678	1816	1953	1839

How to Order

Fabric
See the Logiflex Graded-in List

SS	BC26	PQS			
series	code	top stitching	supplier	pattern	color

Example

SS	BC26	PQS	ENNIS	LOFT	AQUA
----	------	-----	-------	------	------

Modular Seating

Infiniti - Arched Bench

BA26

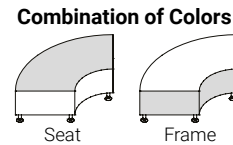
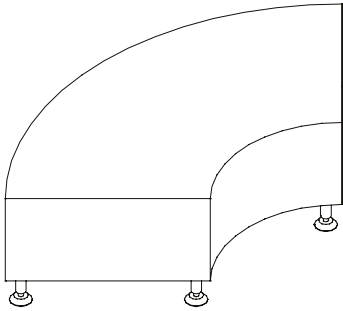

Manufacturing Standards

- 5 brushed chrome metal legs;
- Single top stitching;
- Elastic straps on seat;
- Firm density foam on seat;
- 1/2" thick polyester on the sides of the frame;
- Frame made out of plywood and hardwood..

Number of yards for COM fabric:

Code	Total	Seat	Frame
BA26	3	1.75	1.75

Note: It is recommend that you include a layout with all orders and that you choose a solid fabric color for the seat portion.

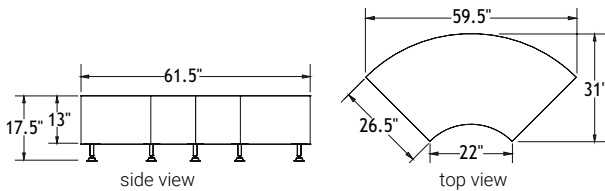

Prices

Code	GRA	GR1	COM	GR2	GR3	GR4	GR5	GR6	GR7	GR8	GR9	GR10	GR11	GR12	Cuir Leather
BA26	1698	1748	1814	1880	1963	2045	2128	2210	2293	2375	2458	2623	2788	2650	

How to Order

Fabric
See the Logiflex Graded-in List

SS	BA26	PQS			
series	code	top stitching	supplier	pattern	color

Example SS BA26 PQS ENNIS LOFT AQUA

Modular Seating

Infiniti - Oval Bench

B026

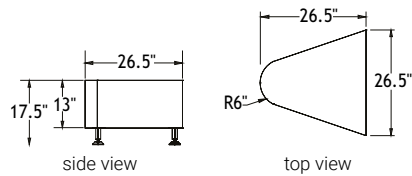
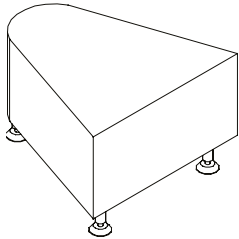

Manufacturing Standards

- 3 brushed chrome metal legs;
- Single top stitching;
- Elastic straps on seat;
- Firm density foam on seat;
- 1/2" thick polyester on the sides of the frame;
- Frame made out of plywood and hardwood..

Combination of Colors

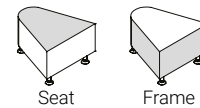

Number of yards for COM fabric:

Code	Total	Seat	Base
B026	2.25	1	1.25

Note: It is recommend that you include a layout with all orders and that you choose a solid fabric color for the seat portion.

Prices

Code	GRA	GR1	COM	GR2	GR3	GR4	GR5	GR6	GR7	GR8	GR9	GR10	GR11	GR12	Cuir Leather
B026	952	989	1039	1088	1150	1212	1274	1336	1397	1459	1521	1645	1769	1666	

How to Order

Fabric
See the Logiflex Graded-in List

SS	B026	PQS			
series	code	top stitching	supplier	pattern	color

Example

SS	B026	PQS	ENNIS	LOFT	AQUA
----	------	-----	-------	------	------

Modular Seating

Infiniti - Square Bench with Padded Arm

BCB26

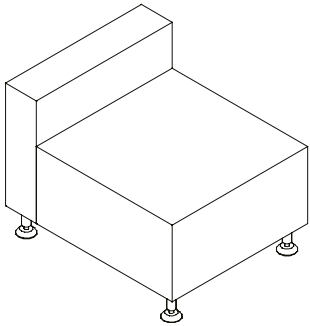

Combination of Colors

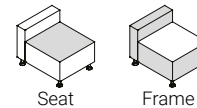

Manufacturing Standards

- 4 brushed chrome metal legs;
- Single top stitching;
- Elastic straps on seat;
- Firm density foam on seat and frame;
- 1/2" thick polyester on the sides of the frame;
- Seat and frame made out of recycled materials.

Number of yards for COM fabric:

Code	Total	Seat	Frame
BCB26	3	,75	2,25

Note: It is recommend that you include a layout with all orders and that you choose a solid fabric color for the seat portion.

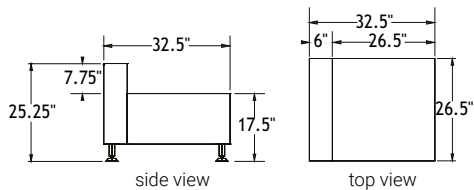

Prices

Code	GRA	GR1	COM GR2	GR3	GR4	GR5	GR6	GR7	GR8	GR9	GR10	GR11	GR12	Cuir Leather
BCB26	1341	1391	1457	1523	1606	1688	1771	1853	1936	2018	2101	2266	2431	2293

How to Order

Fabric
See the Logiflex Graded-in List

SS	BCB26	PQS			
series	code	top stitching	supplier	pattern	color

Example SS BCB26 PQS ENNIS LOFT AQUA

Modular Seating

Infiniti - Square Bench with Padded Arm and Laminate Panel

BCBM26

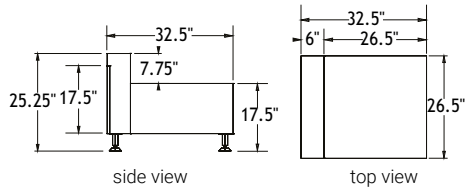
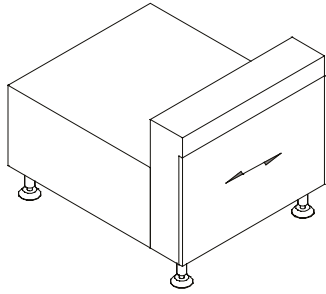

Combination of Colors

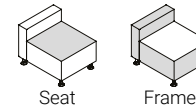

Manufacturing Standards

- 4 brushed chrome metal legs;
- Single top stitching;
- Elastic straps on seat;
- Firm density foam on seat and frame;
- 1/2" thick polyester on the sides of the frame;
- 5/8" thick laminate panel back, 17-1/2"H x 26-1/2"L (choice of Logiflex wood finish laminate color);
- Seat and frame made out of recycled materials.

Number of yards for COM fabric:

Code	Total	Seat	Frame
BCBM26	2.75	.75	2

Note: It is recommend that you include a layout with all orders and that you choose a solid fabric color for the seat portion.



Prices

BCBM26

Code	GRA	GR1	COM GR2	GR3	GR4	GR5	GR6	GR7	GR8	GR9	GR10	GR11	GR12	Cuir Leather
BCBM26	1537	1582	1643	1703	1779	1854	1930	2006	2081	2157	2232	2384	2535	2409

BCBM26 - High Gloss Finish

Code	GRA	GR1	COM GR2	GR3	GR4	GR5	GR6	GR7	GR8	GR9	GR10	GR11	GR12	Cuir Leather
BCBM26	1694	1739	1800	1860	1936	2011	2087	2163	2238	2314	2389	2541	2692	2566

How to Order

Finishes
See the Logiflex Color Guide

Fabric
See the Logiflex Graded-in List

SS	BCBM26	PQS				
series	code	top stitching	supplier	pattern	color	laminat panel

Example	SS	BCBM26	PQS	ENNIS	LOFT	AQUA	GIA
----------------	----	--------	-----	-------	------	------	-----

Modular Seating

Infiniti - Square Bench with Backrest

BCD26

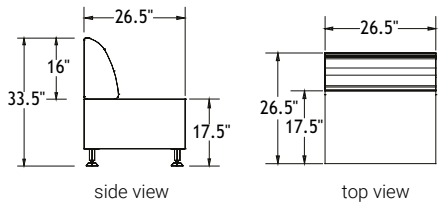
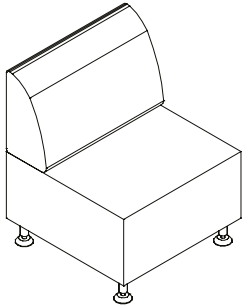

Manufacturing Standards

- 4 brushed chrome metal legs;
- Single top stitching;
- Elastic straps on seat and backrest;
- Firm density foam on seat and backrest;
- 1/2" thick polyester on the sides of the frame;
- Seat and backrest frames made out of recycled materials.

Combination of Colors

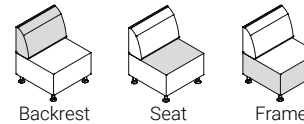

Number of yards for COM fabric:

Code	Total	Backrest	Seat	Frame
BCD26	3.5	1.25	1	1.5

Note: It is recommend that you include a layout with all orders and that you choose a solid fabric color for the seat portion.



Prices

Code	GRA	GR1	COM	GR2	GR3	GR4	GR5	GR6	GR7	GR8	GR9	GR10	GR11	GR12	Cuir Leather
BCD26	1473	1531	1608	1685	1781	1878	1974	2070	2166	2263	2359	2551	2744	2583	

How to Order

Fabric
See the Logiflex Graded-in List

SS	BCD26	PQS			
series	code	top stitching	supplier	pattern	color

Example SS BCD26 PQS ENNIS LOFT AQUA

Modular Seating

Infiniti - Arched Bench with Inner Backrest

BADI26

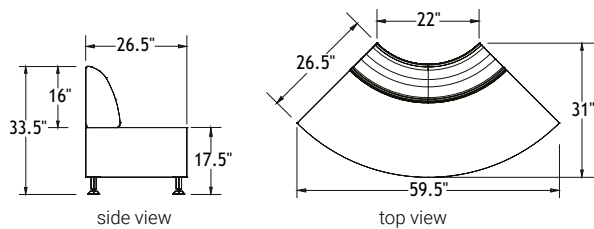
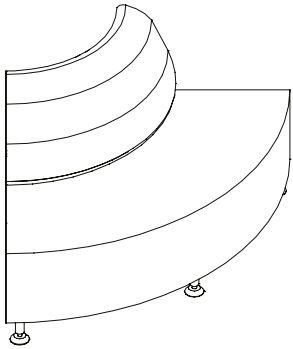

Combination of Colors

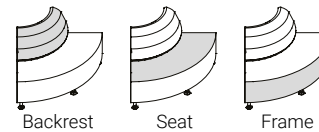

Manufacturing Standards

- 5 brushed chrome metal legs;
- Single top stitching;
- Elastic straps on seat and backrest;
- Firm density foam on seat and backrest;
- 1/2" thick polyester on the sides of the frame;
- Seat and backrest frames made out of recycled materials.

Number of yards for COM fabric:

Code	Total	Backrest	Seat	Frame
BADI26	4.25	1.25	1.75	1.75

Note: It is recommend that you include a layout with all orders and that you choose a solid fabric color for the seat portion.

Prices

Code	GRA	GR1	COM GR2	GR3	GR4	GR5	GR6	GR7	GR8	GR9	GR10	GR11	GR12	Cuir Leather
BADI26	2320	2390	2484	2577	2694	2811	2928	3045	3161	3278	3395	3629	3863	3668

How to Order

Fabric
See the Logiflex Graded-in List

SS	BADI26	PQS			
series	code	top stitching	supplier	pattern	color

Example **SS** **BADI26** **PQS** **ENNIS** **LOFT** **AQUA**

Modular Seating

Infiniti - Arched Bench with Outer Backrest

BADE26

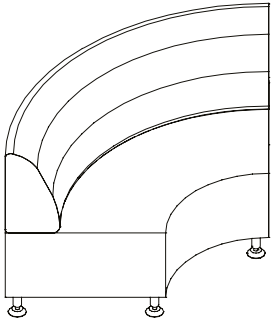

Combination of Colors

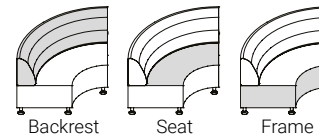

Manufacturing Standards

- 5 brushed chrome metal legs;
- Single top stitching;
- Elastic straps on seat and backrest;
- Firm density foam on seat and backrest;
- 1/2" thick polyester on the sides of the frame;
- Seat and backrest frames made out of recycled materials.

Number of yards for COM fabric:

Code	Total	Backrest	Seat	Frame
BADE26	5.5	2.5	1.75	1.75

Note: It is recommend that you include a layout with all orders and that you choose a solid fabric color for the seat portion.

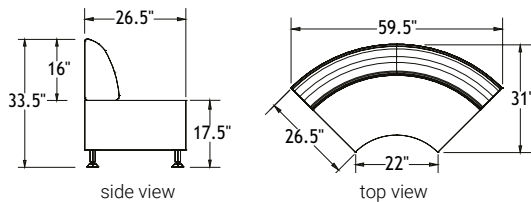

Prices																
Code	GRA	GR1	COM			GR3	GR4	GR5	GR6	GR7	GR8	GR9	GR10	GR11	GR12	Cuir Leather
BADE26	2465	2556	2677	2798	2949	3101	3252	3403	3554	3706	3857	4159	4462	4210		

How to Order

Fabric
See the Logiflex Graded-in List

SS	BADE26	PQS			
series	code	top stitching	supplier	pattern	color

Example SS BADE26 PQS ENNIS LOFT AQUA

Modular Seating

Infiniti - Corner Bench with Backrest

BCCD26

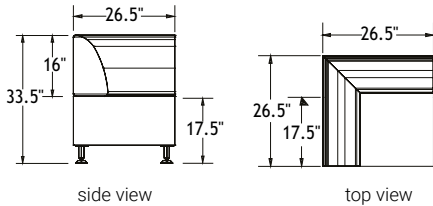
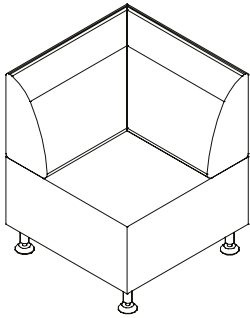

Manufacturing Standards

- 4 brushed chrome metal legs;
- Single top stitching;
- Elastic straps on seat and backrest;
- Firm density foam on seat and backrest;
- 1/2" thick polyester on the sides of the frame;
- Seat and backrest frames made out of recycled materials.

Combination of Colors

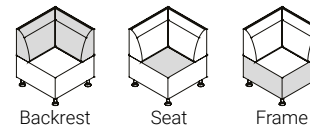

Number of yards for COM fabric:

Code	Total	Backrest	Seat	Frame
BCCD26	5	2.5	.75	1.75

Note: It is recommend that you include a layout with all orders and that you choose a solid fabric color for the seat portion.



Prices

Code	GRA	GR1	COM	GR2	GR3	GR4	GR5	GR6	GR7	GR8	GR9	GR10	GR11	GR12	Cuir Leather
BCCD26	1632	1715	1825	1935	2073	2210	2348	2485	2623	2760	2898	3173	3448	3218	

How to Order

Fabric
See the Logiflex Graded-in List

SS	BCCD26	PQS			
series	code	top stitching	supplier	pattern	color

Example **SS** **BCCD26** **PQS** **ENNIS** **LOFT** **AQUA**

Modular Seating

Infiniti - Rectangular Bench

BC36

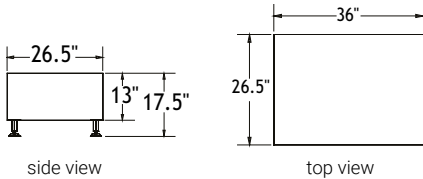
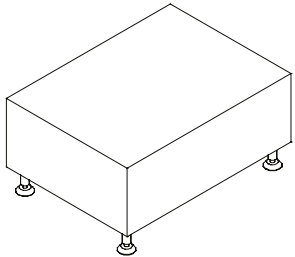

Combination of Colors

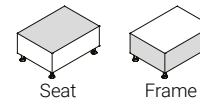

Manufacturing Standards

- 4 brushed chrome metal legs;
- Single top stitching;
- Elastic straps on seat;
- Firm density foam on seat;
- 1/2" thick polyester on the sides of the frame;
- Frame made out of plywood and hardwood..

Number of yards for COM fabric:

Code	Total	Seat	Frame
BC36	2.5	.75	1.75

Note: It is recommend that you include a layout with all orders and that you choose a solid fabric color for the seat portion.

Prices															
Code	GRA	GR1	COM		GR3	GR4	GR5	GR6	GR7	GR8	GR9	GR10	GR11	GR12	Cuir Leather
BC36	1065	1106	1161	1216	1285	1354	1422	1491	1560	1629	1697	1835	1972	1858	

How to Order

Fabric						
See the Logiflex Graded-in List						
SS	BC36	PQS				
series	code	top stitching	supplier	pattern	color	
Example	SS	BC36	PQS	ENNIS	LOFT	AQUA

Modular Seating

Infiniti - Rectangular Bench with Backrest

BCD36

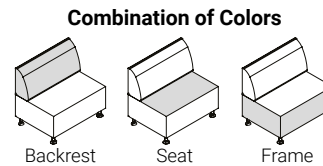
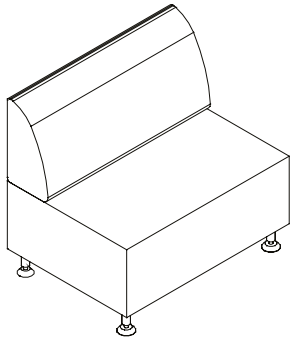

Manufacturing Standards

- 4 brushed chrome metal legs;
- Single top stitching;
- Elastic straps on seat and backrest;
- Firm density foam on seat and backrest;
- 1/2" thick polyester on the sides of the frame;
- Seat and backrest frames made out of recycled materials.

Number of yards for COM fabric:

Code	Total	Backrest	Seat	Frame
BCD36	3.75	1.25	.75	1.75

Note: It is recommend that you include a layout with all orders and that you choose a solid fabric color for the seat portion.

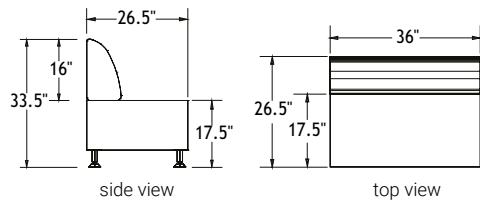

Prices

Code	GRA	GR1	COM	GR2	GR3	GR4	GR5	GR6	GR7	GR8	GR9	GR10	GR11	GR12	Cuir Leather
BCD36	1629	1691	1774	1856	1959	2062	2165	2269	2372	2475	2578	2784	2990	2819	

How to Order

Fabric
See the Logiflex Graded-in List

SS	BCD36	PQS			
series	code	top stitching	supplier	pattern	color
Example SS	BCD36	PQS	ENNIS	LOFT	AQUA

Modular Seating

Infiniti - Rectangular Bench

BC48

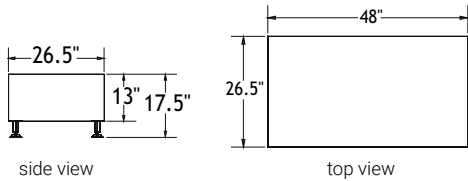
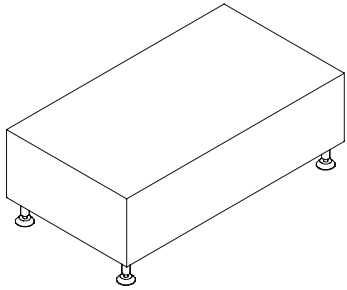

Manufacturing Standards

- 4 brushed chrome metal legs;
- Single top stitching;
- Elastic straps on seat;
- Firm density foam on seat;
- 1/2" thick polyester on the sides of the frame;
- Frame made out of plywood and hardwood..

Combination of Colors

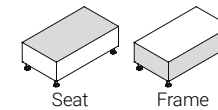

Number of yards for COM fabric:

Code	Total	Seat	Frame
BC48	2.75	.75	1.75

Note: It is recommend that you include a layout with all orders and that you choose a solid fabric color for the seat portion.



Prices

Code	GRA	GR1	COM GR2	GR3	GR4	GR5	GR6	GR7	GR8	GR9	GR10	GR11	GR12	Cuir Leather
BC48	1240	1285	1346	1406	1482	1557	1633	1709	1784	1860	1935	2087	2238	2112

How to Order

Fabric
See the Logiflex Graded-in List

SS	BC48	PQS			
series	code	top stitching	supplier	pattern	color

Example SS BC48 PQS ENNIS LOFT AQUA

Modular Seating

Infiniti - Rectangular Bench with Backrest

BCD48

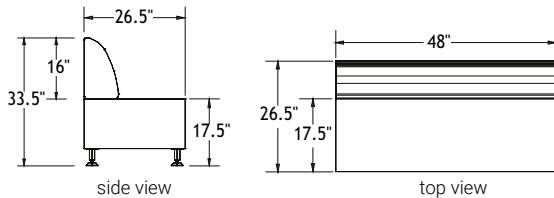
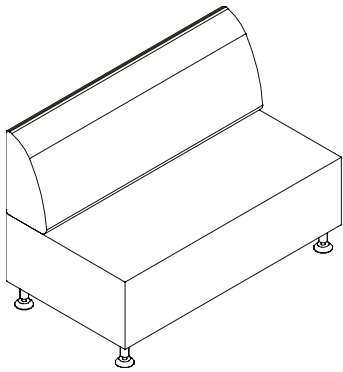

Combination of Colors

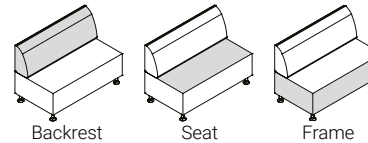

Manufacturing Standards

- 4 brushed chrome metal legs;
- Single top stitching;
- Elastic straps on seat and backrest;
- Firm density foam on seat and backrest;
- 1/2" thick polyester on the sides of the frame;
- Seat and backrest frames made out of recycled materials.

Number of yards for COM fabric:

Code	Total	Backrest	Seat	Frame
BCD48	4.5	2	.75	1.75

Note: It is recommend that you include a layout with all orders and that you choose a solid fabric color for the seat portion.



Prices

Code	GRA	GR1	COM	GR2	GR3	GR4	GR5	GR6	GR7	GR8	GR9	GR10	GR11	GR12	Cuir Leather
BCD48	1886	1960	2059	2158	2282	2406	2529	2653	2777	2901	3024	3272	3519	3313	

How to Order

Fabric
See the Logiflex Graded-in List

SS	BCD48	PQS			
series	code	top stitching	supplier	pattern	color

Example SS BCD48 PQS ENNIS LOFT AQUA

Modular Seating

Infiniti - Rectangular Bench with 30" Backrest on Left

BCDC48L

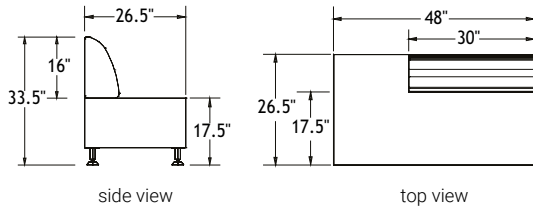
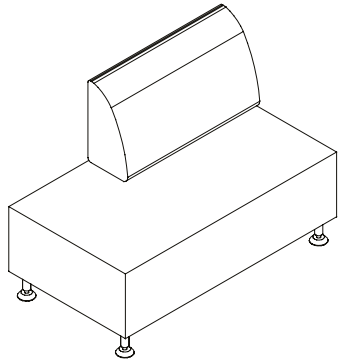

Manufacturing Standards

- 4 brushed chrome metal legs;
- Single top stitching;
- Elastic straps on seat and backrest;
- Firm density foam on seat and backrest;
- 1/2" thick polyester on the sides of the frame;
- Seat and backrest frames made out of recycled materials.

Combination of Colors

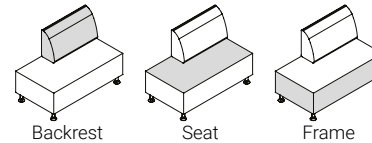

Number of yards for COM fabric:

Code	Total	Backrest	Seat	Frame
BCDC48L	4.5	2	.75	1.75

Note: It is recommend that you include a layout with all orders and that you choose a solid fabric color for the seat portion.



Prices

Code	GRA	GR1	COM GR2	GR3	GR4	GR5	GR6	GR7	GR8	GR9	GR10	GR11	GR12	Cuir Leather
BCDC48L	1840	1914	2013	2112	2236	2360	2483	2607	2731	2855	2978	3226	3473	3267

How to Order

Fabric
See the Logiflex Graded-in List

SS	BCDC48L	PQS			
series	code	top stitching	supplier	pattern	color

Example SS BCDC48L PQS ENNIS LOFT AQUA

Modular Seating

Infiniti - Rectangular Bench with 30" Backrest on Right

BCDC48R

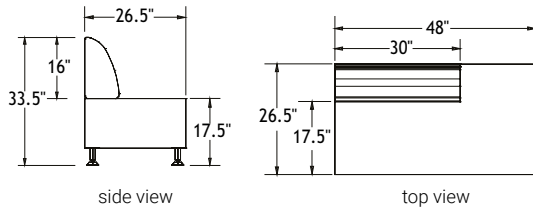
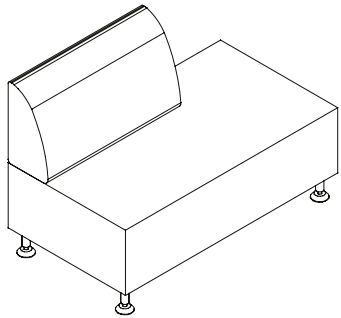

Combination of Colors

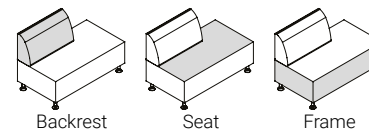

Manufacturing Standards

- 4 brushed chrome metal legs;
- Single top stitching;
- Elastic straps on seat and backrest;
- Firm density foam on seat and backrest;
- 1/2" thick polyester on the sides of the frame;
- Seat and backrest frames made out of recycled materials.

Number of yards for COM fabric:

Code	Total	Backrest	Seat	Frame
BCDC48R	4.5	2	.75	1.75

Note: It is recommend that you include a layout with all orders and that you choose a solid fabric color for the seat portion.

Prices

Code	GRA	GR1	COM GR2	GR3	GR4	GR5	GR6	GR7	GR8	GR9	GR10	GR11	GR12	Cuir Leather
BCDC48R	1840	1914	2013	2112	2236	2360	2483	2607	2731	2855	2978	3226	3473	3267

How to Order

Fabric
See the Logiflex Graded-in List

SS	BCDC48R	PQS			
series	code	top stitching	supplier	pattern	color

Example SS BCDC48R PQS ENNIS LOFT AQUA

Modular Seating

Clara - Circular Bench

CLA

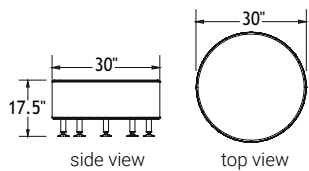
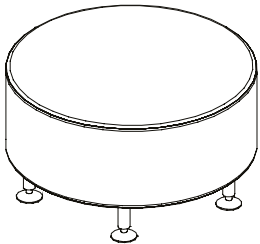

Combination of Colors

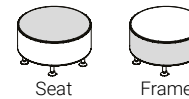

Manufacturing Standards

- 5 brushed chrome metal legs;
- Single top stitching;
- Firm density foam on seat;
- 1/2" thick polyester on the sides of the frame;
- Frame made out of recycled materials.

Number of yards for COM fabric:

Code	Total	Seat	Frame
CLA	1.75	1	1

Note: It is recommend that you include a layout with all orders and that you choose a solid fabric color for the seat portion.



Prices

Code	GRA	GR1	COM GR2	GR3	GR4	GR5	GR6	GR7	GR8	GR9	GR10	GR11	GR12	Cuir Leather
CLA	1313	1342	1381	1419	1467	1515	1563	1612	1660	1708	1756	1852	1948	1868

How to Order

Fabric
See the Logiflex Graded-in List

SS	CLA			
series	code	supplier	pattern	color
SS	CLA	ENNIS	LOFT	AQUA

Example SS CLA ENNIS LOFT AQUA

Modular Seating



Clara - Circular Single Nestle Bench

CLAS

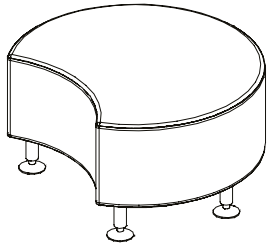

Manufacturing Standards

- 5 brushed chrome metal legs;
- Single top stitching;
- Firm density foam on seat;
- 1/2" thick polyester on the sides of the frame;
- Frame made out of recycled materials.

Combination of Colors

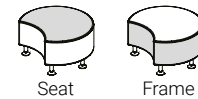

Number of yards for COM fabric:

Code	Total	Seat	Frame
CLAS	1.75	1	1

Note: It is recommend that you include a layout with all orders and that you choose a solid fabric color for the seat portion.

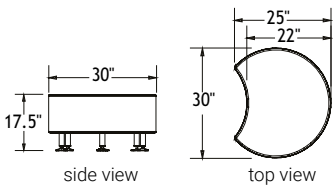

Prices															
Code	GRA	GR1	COM	GR2	GR3	GR4	GR5	GR6	GR7	GR8	GR9	GR10	GR11	GR12	Cuir Leather
CLAS	1313	1342	1381	1419	1467	1515	1563	1612	1660	1708	1756	1852	1948	1868	

How to Order

Fabric
See the Logiflex Graded-in List

SS	CLAS			
series	code	supplier	pattern	color

Example SS CLAS ENNIS LOFT AQUA

Modular Seating



Clara - Circular Double Nestle Bench

CLAD

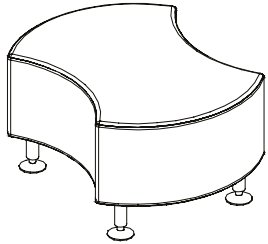

Manufacturing Standards

- 5 brushed chrome metal legs;
- Single top stitching;
- Firm density foam on seat;
- 1/2" thick polyester on the sides of the frame;
- Frame made out of recycled materials.

Combination of Colors

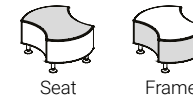

Number of yards for COM fabric:

Code	Total	Seat	Frame
CLAD	1.75	1	1

Note: It is recommend that you include a layout with all orders and that you choose a solid fabric color for the seat portion.

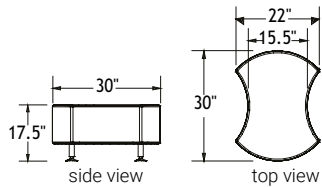

Prices

Code	GRA	GR1	COM GR2	GR3	GR4	GR5	GR6	GR7	GR8	GR9	GR10	GR11	GR12	Cuir Leather
CLAD	1313	1342	1381	1419	1467	1515	1563	1612	1660	1708	1756	1852	1948	1868

How to Order

Fabric
See the Logiflex Graded-in List

SS	CLAD			
series	code	supplier	pattern	color

Example SS CLAD ENNIS LOFT AQUA

Modular Seating

Clara - Circular Bench with Backrest

CLAB

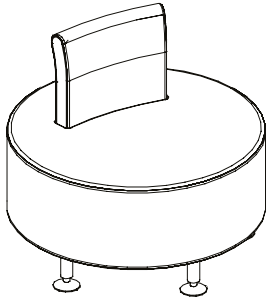

Combination of Colors

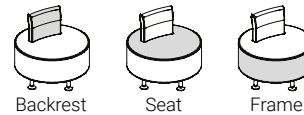

Manufacturing Standards

- 5 brushed chrome metal legs;
- Single top stitching;
- Elastic straps on backrest;
- Firm density foam on seat;
- 1/2" thick polyester on the sides of the frame;
- Frame made out of recycled materials.

Number of yards for COM fabric:

Code	Total	Backrest	Seat	Frame
CLAB	2	1	1	1

Note: It is recommend that you include a layout with all orders and that you choose a solid fabric color for the seat portion.

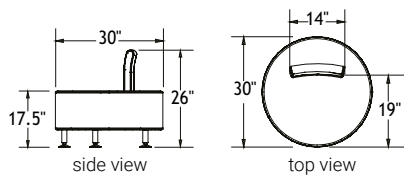

Prices

Code	GRA	GR1	COM	GR2	GR3	GR4	GR5	GR6	GR7	GR8	GR9	GR10	GR11	GR12	Cuir Leather
CLAB	2265	2298	2342	2386	2441	2496	2551	2606	2661	2716	2771	2881	2991	2899	

How to Order

Fabric
See the Logiflex Graded-in List

SS	CLAB			
series	code	supplier	pattern	color
SS	CLAB	ENNIS	LOFT	AQUA

Example SS CLAB ENNIS LOFT AQUA

Modular Seating

Leo - Circular Bench

LEO18

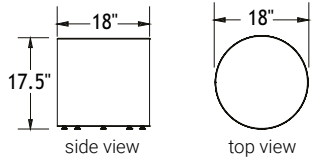
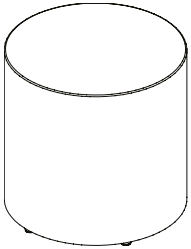

Manufacturing Standards

- Single top stitching;
- Firm density foam on seat;
- 1/2" thick polyester on the sides of the frame;
- Frame made out of recycled materials;
- On white nylon levelers;
- Total weight: 12.5 lbs.

Nylon Band: The height of the nylon band is 3-1/2" and is only offered in Momentum - Parable Shadow fabric.

Loop Handle: The interior fabric of the loop is in Momentum - Parable Shadow fabric.

Number of yards for COM fabric:

Code	Total	Seat	Frame
LEO18	1.25	.75	1.25

Note: It is recommend that you include a layout with all orders.

Combination of Colors

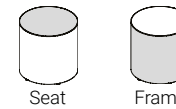

Options

Nylon Band

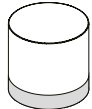

NYL
\$78

Loop Handle

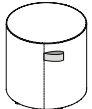

LOOP
\$110

Prices

Code	GRA	GR1	COM GR2	GR3	GR4	GR5	GR6	GR7	GR8	GR9	GR10	GR11	GR12	Cuir Leather
LEO18	682	703	731	758	792	827	861	896	930	964	999	1067	1136	1079

How to Order

SS	LEO18	NYL	LOOP	Fabric <i>See the Logiflex Graded-in List</i>		
series	code	nylon band	loop handle	supplier	pattern	color
Example SS	LEO18	NYL	LOOP	ENNIS	LOFT	AQUA

Modular Seating

Leo - Circular Bench

LEO30

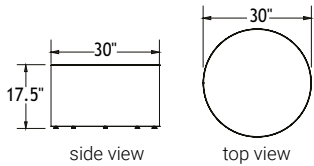
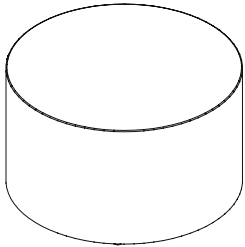

Manufacturing Standards

- Single top stitching;
- Firm density foam on seat;
- 1/2" thick polyester on the sides of the frame;
- Frame made out of recycled materials;
- On white nylon levelers.

Nylon Band: The height of the nylon band is 3-1/2" and is only offered in Momentum - Parable Shadow fabric.

Number of yards for COM fabric:

Code	Total	Seat	Frame
LEO30	2.25	1	1.25

Note: It is recommend that you include a layout with all orders.

Combination of Colors

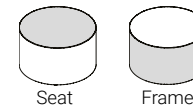

+ Options

Nylon Band

NYL
\$133

\$ Prices

Code	GRA	GR1	COM GR2	GR3	GR4	GR5	GR6	GR7	GR8	GR9	GR10	GR11	GR12	Cuir Leather
LEO30	1212	1249	1299	1348	1410	1527	1534	1596	1657	1719	1781	1905	2029	1926

How to Order

SS	LEO30	NYL	Fabric <i>See the Logiflex Graded-in List</i>		
series	code	nylon band	supplier	pattern	color
Example SS	LEO30	NYL	ENNIS	LOFT	AQUA

Modular Seating

Leo - Circular Bench with Laminate Top

LEOT

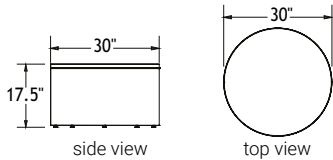
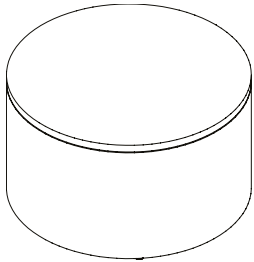

Combination of Colors

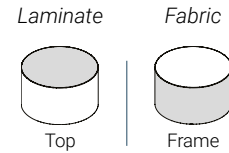

Manufacturing Standards

- 1" laminate top;
- 1/2" thick polyester on the sides of the frame;
- Frame made out of recycled materials;
- On white nylon levelers.

Nylon Band: The height of the nylon band is 3-1/2" and is only offered in Momentum - Parable Shadow fabric.

Number of yards for COM fabric:

Code	Total	Frame
LEOT	1.25	1.25

Note: It is recommend that you include a layout with all orders.

Options

Nylon Band

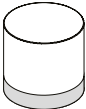

NYL
\$133

Marker Board



MB
\$248

Prices

Code	GRA	GR1	COM GR2	GR3	GR4	GR5	GR6	GR7	GR8	GR9	GR10	GR11	GR12	Cuir Leather
LEOT	1382	1403	1431	1458	1492	1527	1561	1596	1630	1664	1699	1767	1836	1779

How to Order

SS	LEOT	NYL	MB	Fabric <i>See the Logiflex Graded-in List</i>				Finishes <i>See the Logiflex Color Guide</i>
series	code	nylon band	marker board	supplier	pattern	color	top	
Example SS	LEOT	NYL	MB	ENNIS	LOFT	AQUA	GIA	

Modular Seating

Leo - Square Bench

LEOC18

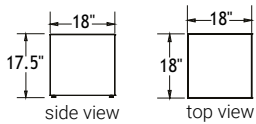
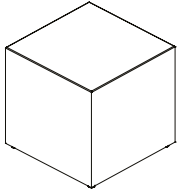

Combination of Colors

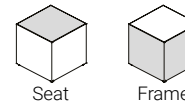

Manufacturing Standards

- Single top stitching;
- Firm density foam on seat;
- 1/2" thick polyester on the sides of the frame;
- Frame made out of recycled materials;
- On white nylon levelers;
- Total weight: 14.5 lbs.

Nylon Band: The height of the nylon band is 3-1/2" and is only offered in Momentum - Parable Shadow fabric.

Loop Handle: The interior fabric of the loop is in Momentum - Parable Shadow fabric.

Number of yards for COM fabric:

Code	Total	Seat	Frame
LEOC18	2	.75	1.25

Note: It is recommend that you include a layout with all orders.

Options

Nylon Band

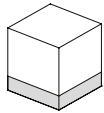

NYL
\$98

Loop Handle

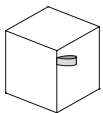

LOOP
\$110

Prices

Code	GRA	GR1	COM GR2	GR3	GR4	GR5	GR6	GR7	GR8	GR9	GR10	GR11	GR12	Cuir Leather
LEOC18	703	736	780	824	879	1571	989	1044	1099	1154	1209	1319	1429	1337

How to Order

SS	LEOC18	NYL	LOOP	Fabric <i>See the Logiflex Graded-in List</i>			
series	code	nylon band	loop handle	supplier	pattern	color	
Example	SS	LEOC18	NYL	LOOP	ENNIS	LOFT	AQUA

Modular Seating

Leo - Square Bench

LEOC30

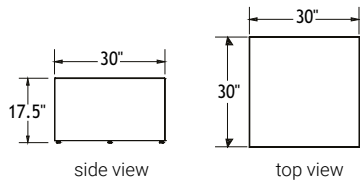
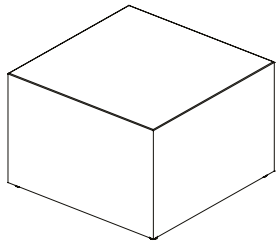

Manufacturing Standards

- Single top stitching;
- Firm density foam on seat;
- 1/2" thick polyester on the sides of the frame;
- Frame made out of recycled materials;
- On white nylon levelers.

Nylon Band: The height of the nylon band is 3-1/2" and is only offered in Momentum - Parable Shadow fabric.

Number of yards for COM fabric:

Code	Total	Seat	Frame
LEOC30	3.25	1	2.25

Note: It is recommend that you include a layout with all orders.

Combination of Colors

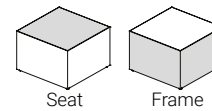

Options

Nylon Band

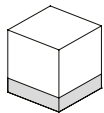

NYL
\$232

Prices

Code	GRA	GR1	COM GR2	GR3	GR4	GR5	GR6	GR7	GR8	GR9	GR10	GR11	GR12	Cuir Leather
LEOC30	1195	1249	1321	1392	1481	1571	1660	1750	1839	1928	2018	2196	2375	2226

How to Order

SS	LEOC30	NYL	Fabric <i>See the Logiflex Graded-in List</i>		
series	code	nylon band	supplier	pattern	color
Example SS	LEOC30	NYL	ENNIS	LOFT	AQUA

Modular Seating

Leo - Square Bench with Laminate Top

LEOCT

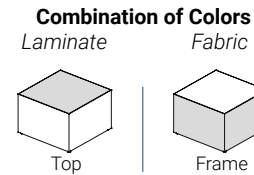
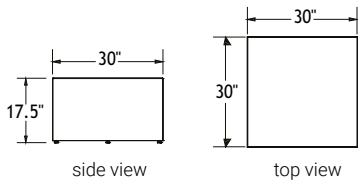
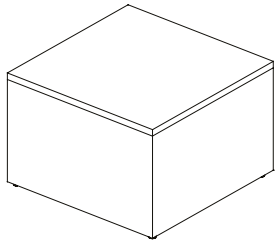

Manufacturing Standards

- 1" laminate top;
- 1/2" thick polyester on the sides of the frame;
- Frame made out of recycled materials;
- On white nylon levelers.

Nylon Band: The height of the nylon band is 3-1/2" and is only offered in Momentum - Parable Shadow fabric.

Number of yards for COM fabric:

Code	Total	Frame
LEOCT	2,25	2,25

Note: It is recommend that you include a layout with all orders.

Options

Nylon Band

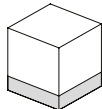

NYL
\$232

Marker Board



MB
\$248

Prices

Code	GRA	GR1	COM GR2	GR3	GR4	GR5	GR6	GR7	GR8	GR9	GR10	GR11	GR12	Cuir Leather
LEOCT	1366	1403	1453	1502	1564	1626	1688	1750	1811	1873	1935	2059	2183	2080

How to Order

SS	LEOCT	NYL	MB	Fabric <i>See the Logiflex Graded-in List</i>			Finishes <i>See the Logiflex Color Guide</i>	
series	code	nylon band	marker board	supplier	pattern	color	top	
Example	SS	LEOCT	NYL	MB	ENNIS	LOFT	AQUA	GIA

Soft Seating

Alpha - Single Armchair

1403

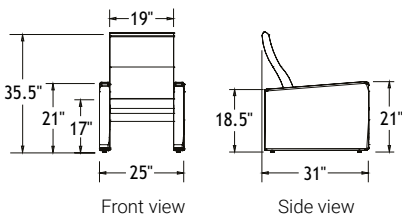
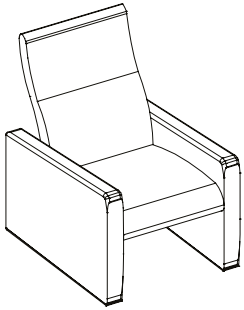

Combination of Colors

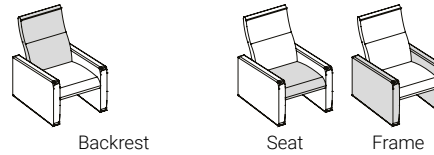

Manufacturing Standards

- 4 levelers, 7/8" diameter;
- Single top stitching;
- Medium-density foam on seat;
- 1" memory foam on backrest;
- Molded wood boards for seat and backrest;
- Rest of frame made out of recycled materials.

Number of yards for COM fabric:

Code	Total	Backrest	Seat	Frame
1403	4.25	1.75	1	1.5



Prices

Code	GRA	GR1	COM GR2	GR3	GR4	GR5	GR6	GR7	GR8	GR9	GR10	GR11	GR12	Cuir Leather
1403	1437	1511	1610	1709	1833	1957	2080	2204	2328	2452	2575	2823	3070	2864

How to Order

Fabric

[See the Logiflex Graded-in List](#)

SS	1403	N			
series	code	leveler	supplier	pattern	color

Example

SS	1403	N	ENNIS	LOFT	AQUA
-----------	-------------	----------	--------------	-------------	-------------

Soft Seating

Alpha - Double Armchair

1405

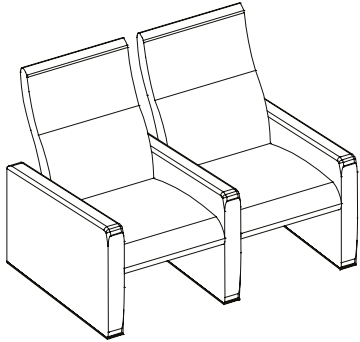

Combination of Colors

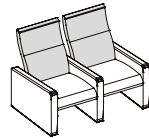

Backrest

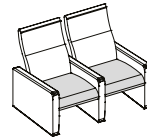

Seat

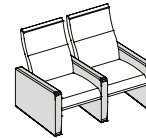

Frame

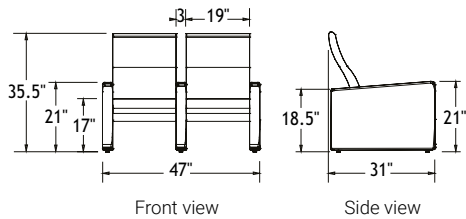

Manufacturing Standards

- 6 levelers, 7/8" diameter;
- Single top stitching;
- Medium-density foam on seat;
- 1" memory foam on backrest;
- Molded wood boards for seat and backrest;
- Rest of frame made out of recycled materials.

Number of yards for COM fabric:

Code	Total	Backrest	Seat	Frame
1405	5.5	1.75	1.5	2.25

Prices														
Code	GRA	GR1	COM GR2	GR3	GR4	GR5	GR6	GR7	GR8	GR9	GR10	GR11	GR12	Cuir Leather
1405	2510	2601	2722	2843	2994	3146	3297	3448	3599	3751	3902	4204	4507	4255

How to Order

Fabric

[See the Logiflex Graded-in List](#)

SS	1405	N			
series	code	leveler	supplier	pattern	color

Example	SS	1405	N	ENNIS	LOFT	AQUA
----------------	----	------	---	-------	------	------

Soft Seating

Alpha - Triple Armchair

1407

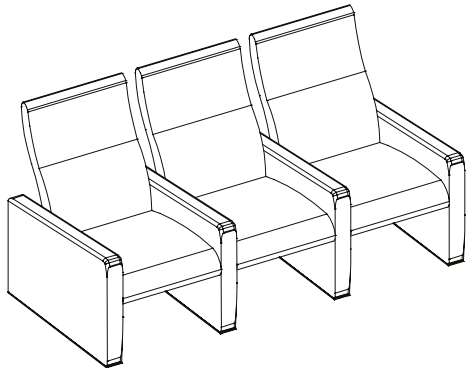

Combination of Colors

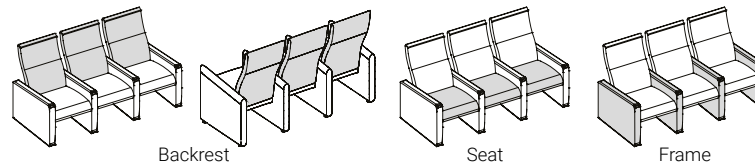

Manufacturing Standards

- 8 levelers, 7/8" diameter;
- Single top stitching;
- Medium-density foam on seat;
- 1" memory foam on backrest;
- Molded wood boards for seat and backrest;
- Rest of frame made out of recycled materials.

Number of yards for COM fabric:

Code	Total	Backrest	Seat	Frame
1407	8.75	3.5	2.25	3

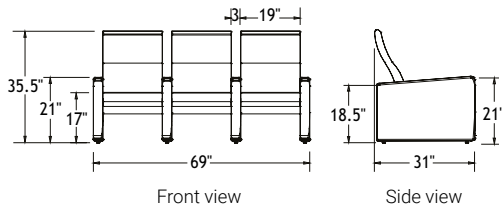

														Prices	
Code	GRA	GR1	COM		GR3	GR4	GR5	GR6	GR7	GR8	GR9	GR10	GR11	GR12	Cuir Leather
1407	3121	3265	3458	3650	3891	4131	4372	4613	4853	5094	5334	5816	6297	5896	

How to Order

Fabric
See the Logiflex Graded-in List

SS	1407	N			
series	code	leveler	supplier	pattern	color

Example

SS	1407	N	ENNIS	LOFT	AQUA
-----------	-------------	----------	--------------	-------------	-------------

Soft Seating

Bulexi - Armchair

5010

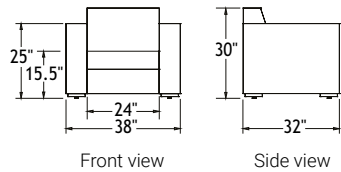
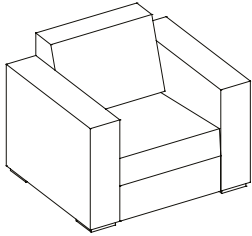

Manufacturing Standards

- Set of 4 wood legs BWL;
- Double top stitching;
- Elastic straps on backrest;
- 9 GA springs within the seat;
- Medium-density foam on the seat;
- Medium-density foam with 1" of memory foam for the backrest;
- All cushions are covered with stitched Dacron;
- Backrest cushions are fixed to the structure by a zipper;
- Made out of recycled materials, seating and backrest structure made of hardwood and plywood.

Option: Set of 4 chrome metal legs, BCHR.

Wood finishes: Available colors: White Wash WW, Golden Wheat GW, Sand SD, Apricot AT, Pecan PN, Brandy BR, Chestnut CT, Coffee CF, Espresso ES, Bordeaux BO, Black Wash BW and Bark BK.

Number of yards for COM fabric:

Code	Total	Backrest	Seat	Frame
5010	5.5	1.25	2	3.5

Combination of Colors

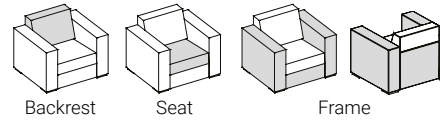

Prices														
Code	GRA	GR1	COM									Cuir	Leather	
5010 BWL	2335	2426	2547	2668	2819	2971	3122	3273	3424	3576	3727	4029	4332	4080
5010 BCHR	2919	3010	3131	3252	3403	3555	3706	3857	4008	4160	4311	4613	4916	4664

How to Order

		BCHR BWL (std)	Finishes <i>See the Logiflex Color Guide</i>	Fabric <i>See the Logiflex Graded-in List</i>			
SS	5010						
series	code	legs	leg color	supplier	pattern	color	
Example	SS	5010	BWL	BK	ENNIS	LOFT	AQUA

Soft Seating

Bulexi - Loveseat

5020

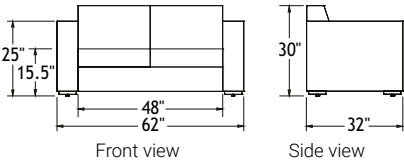
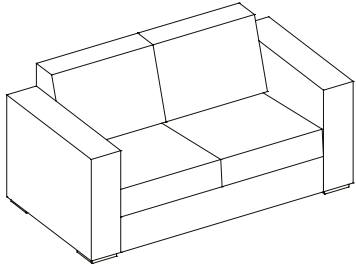

Combination of Colors

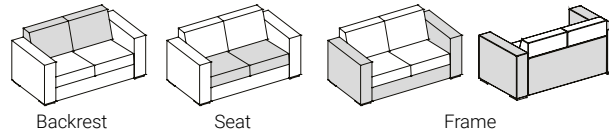

Manufacturing Standards

- Set of 4 wood legs BWL;
- Double top stitching;
- Elastic straps on backrest;
- 9 GA springs within the seat;
- Medium-density foam on the seat;
- Medium-density foam with 1" of memory foam for the backrest;
- All cushions are covered with stitched Dacron;
- Backrest cushions are fixed to the structure by a zipper;
- Made out of recycled materials, seating and backrest structure made of hardwood and plywood.

Option: Set of 4 chrome metal legs, BCHR.

Wood finishes: Available colors: White Wash WW, Golden Wheat GW, Sand SD, Apricot AT, Pecan PN, Brandy BR, Chestnut CT, Coffee CF, Espresso ES, Bordeaux BO, Black Wash BW and Bark BK.

Number of yards for COM fabric:

Code	Total	Backrest	Seat	Frame
5020	8	2.5	4	4

Prices

Code	GRA	GR1	COM GR2	GR3	GR4	GR5	GR6	GR7	GR8	GR9	GR10	GR11	GR12	Cuir Leather
5020 BWL	3616	3748	3924	4100	4320	4540	4760	4980	5200	5420	5640	6080	6520	6153
5020 BCHR	4186	4318	4494	4670	4890	5110	5330	5550	5770	5990	6210	6650	7090	6723

How to Order

SS	5020	BCHR BWL (std)	Finishes See the Logiflex Color Guide	Fabric See the Logiflex Graded-in List		
series	code	legs	leg color	supplier	pattern	color
Example SS	5020	BWL	BK	ENNIS	LOFT	AQUA

Soft Seating

Bulexi - Sofa

5030

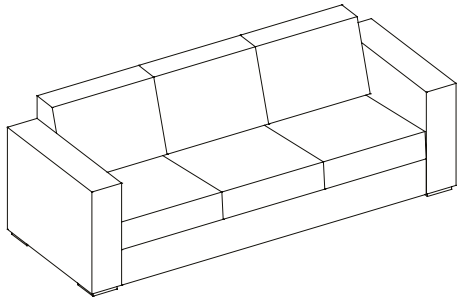

Combination of Colors

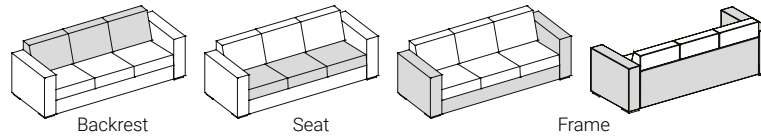

Manufacturing Standards

- Set of 4 wood legs BWL;
- Double top stitching;
- Elastic straps on backrest;
- 9 GA springs within the seat;
- Medium-density foam on the seat;
- Medium-density foam with 1" of memory foam for the backrest;
- All cushions are covered with stitched Dacron;
- Backrest cushions are fixed to the structure by a zipper;
- Made out of recycled materials, seating and backrest structure made of hardwood and plywood.

Option: Set of 4 chrome metal legs, BCHR.

Wood finishes: Available colors: White Wash WW, Golden Wheat GW, Sand SD, Apricot AT, Pecan PN, Brandy BR, Chestnut CT, Coffee CF, Espresso ES, Bordeaux BO, Black Wash BW and Bark BK.

Number of yards for COM fabric:

Code	Total	Backrest	Seat	Frame
5030	10.5	5	6	4.5

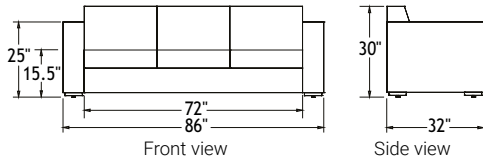

Prices														
Code	GRA	GR1	COM									Cuir	Leather	
5030 BWL	4598	4771	5002	5233	5522	5811	6099	6388	6677	6966	7254	7832	8409	7928
5030 BCHR	5185	5358	5589	5820	6109	6398	6686	6975	7264	7553	7841	8419	8996	8515

How to Order

		BCHR BWL (std)	Finishes See the Logiflex Color Guide	Fabric See the Logiflex Graded-in List			
SS	5030						
series	code	legs	leg color	supplier	pattern	color	
Example	SS	5030	BWL	BK	ENNIS	LOFT	AQUA

Soft Seating

Dean - Armchair

DEA1

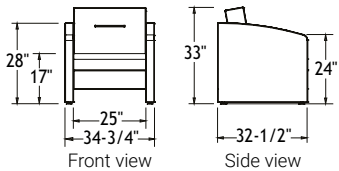
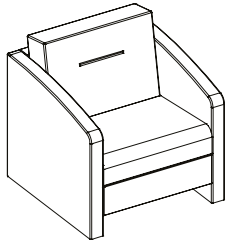

Combination of Colors

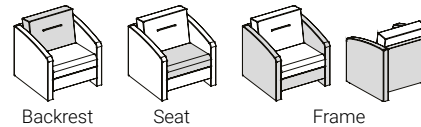

Manufacturing Standards

- Springs for the seat and backrest;
- Single top stitching;
- Medium-density foam;
- Frame made out of recycled and recyclable particles.

Option: Set of 4 metal oval legs in satin nickel finish, OVAMSN.

Number of yards for COM fabric:

Code	Total	Backrest	Seat	Frame
DEA1	5.75	1.25	1	3

Options

Legs

Set of 4 oval metal corner legs on leveler. Satin Nickel finish. 4"H



OVAMSN
\$0

Prices

Code	GRA	GR1	COM GR2	GR3	GR4	GR5	GR6	GR7	GR8	GR9	GR10	GR11	GR12	Cuir Leather
DEA1	1753	1848	1975	2101	2259	2417	2575	2734	2892	3050	3208	3524	3840	3577

How to Order

SS	DEA1	OVAMSN	Fabric <i>See the Logiflex Graded-in List</i>		
series	code	legs	supplier	pattern	color
Example SS	DEA1	OVAMSN	ENNIS	LOFT	AQUA

Soft Seating

Dean - Loveseat

DEA2

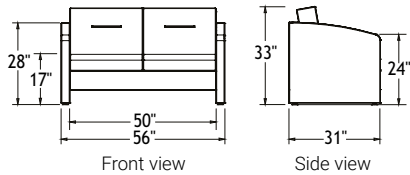
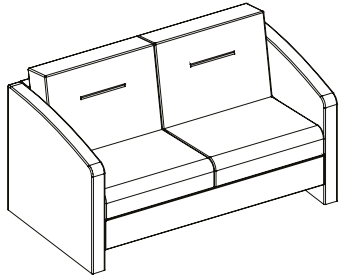

Combination of Colors

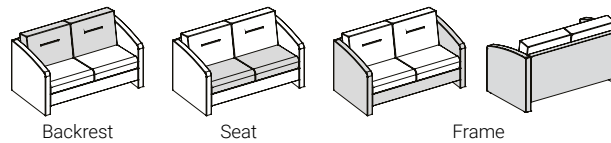

Manufacturing Standards

- Springs for the seat and backrest;
- Single top stitching;
- Medium-density foam;
- Frame made out of recycled and recyclable particles.

Option: Set of 4 metal oval legs in satin nickel finish, OVAMSN.

Number of yards for COM fabric:

Code	Total	Backrest	Seat	Frame
DEA2	7.75	2.5	1.75	3.75

Options

Legs
Set of 4 oval metal corner legs on leveler. Satin Nickel finish. 4"H

OVAMSN
\$0

Prices

Code	GRA	GR1	COM GR2	GR3	GR4	GR5	GR6	GR7	GR8	GR9	GR10	GR11	GR12	Cuir Leather
DEA2	2508	2636	2807	2977	3190	3403	3616	3830	4043	4256	4469	4895	5321	4966

How to Order

SS	DEA2	OVAMSN	Fabric <i>See the Logiflex Graded-in List</i>		
series	code	legs	supplier	pattern	color
Example SS	DEA2	OVAMSN	ENNIS	LOFT	AQUA

Soft Seating

Dean - Sofa

DEA3

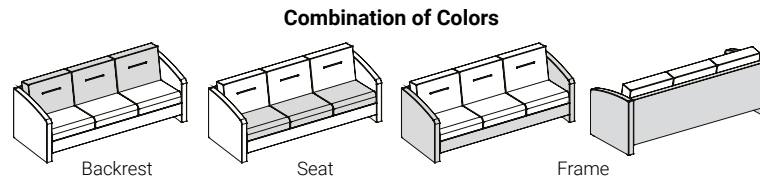
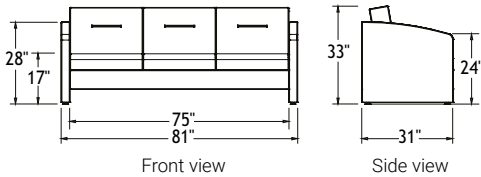
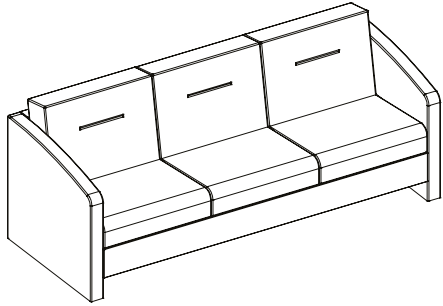

Combination of Colors

Manufacturing Standards

- Springs for the seat and backrest;
- Single top stitching;
- Medium-density foam;
- Frame made out of recycled and recyclable particles.

Option: Set of 4 metal oval legs in satin nickel finish, OVAMSN.

Number of yards for COM fabric:

Code	Total	Backrest	Seat	Frame
DEA3	10.5	3.5	2.75	4.25

Options

Legs

Set of 4 oval metal corner legs on leveler. Satin Nickel finish. 4"H



OVAMSN
\$0

Prices

Code	GRA	GR1	COM GR2	GR3	GR4	GR5	GR6	GR7	GR8	GR9	GR10	GR11	GR12	Cuir Leather
DEA3	3395	3568	3799	4030	4319	4608	4896	5185	5474	5763	6051	6629	7206	6725

How to Order

			+			
			OVAMSN	Fabric <i>See the Logiflex Graded-in List</i>		
SS	DEA3					
series	code	legs	supplier	pattern	color	
Example	SS	DEA3	OVAMSN	ENNIS	LOFT	AQUA

Soft Seating

Flint - Armchair

3010FBW

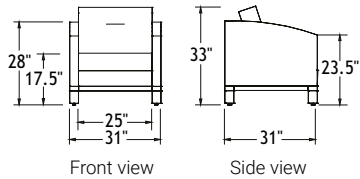
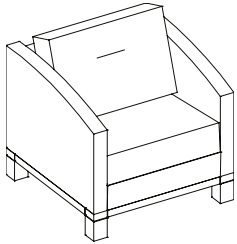

Manufacturing Standards

- Wooden base FBW with 4 legs;
- Single top stitching;
- 9 GA springs for the seat and 11 GA for the backrest;
- Medium-density foam on seat and backrest;
- Firm density foam on the top of the armrests;
- Frame made out of recycled materials and hardwood for seating base.

Wood finishes: Available colors: White Wash WW, Golden Wheat GW, Sand SD, Apricot AT, Pecan PN, Brandy BR, Chestnut CT, Coffee CF, Espresso ES, Bordeaux BO, Black Wash BW and Bark BK.

Number of yards for COM fabric:

Code	Total	Backrest	Seat	Frame
3010FBW	4	1.25	1	3

Combination of Colors

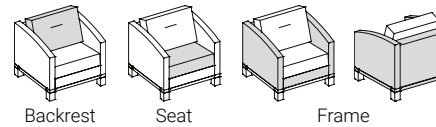

Options

Double Stitching

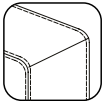

\$0

Prices

Code	GRA	GR1	COM	GR2	GR3	GR4	GR5	GR6	GR7	GR8	GR9	GR10	GR11	GR12	Cuir Leather
3010FBW	1849	1915	2003	2091	2201	2311	2421	2531	2641	2751	2861	3081	3301	3118	

How to Order

		+	Finishes <i>See the Logiflex Color Guide</i>	Fabric <i>See the Logiflex Graded-in List</i>			
SS	3010FBW	PQD PQS (std)					
series	code	top stitch	leg color	supplier	pattern	color	
Example	SS	3010FBW	PQS	BK	ENNIS	LOFT	AQUA

Soft Seating

Flint - Loveseat

3020FBW

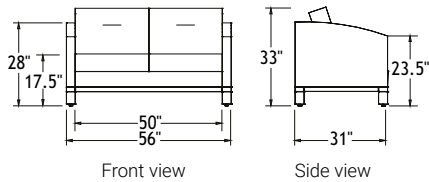
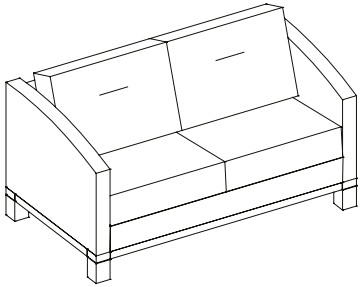

Combination of Colors

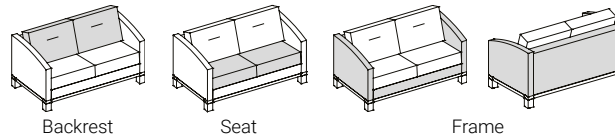

Manufacturing Standards

- Wooden base FBW with 4 legs;
- Single top stitching;
- 9 GA springs for the seat and 11 GA for the backrest;
- Medium-density foam on seat and backrest;
- Firm density foam on the top of the armrests;
- Frame made out of recycled materials and hardwood for seating base.

Wood finishes: Available colors: White Wash WW, Golden Wheat GW, Sand SD, Apricot AT, Pecan PN, Brandy BR, Chestnut CT, Coffee CF, Espresso ES, Bordeaux BO, Black Wash BW and Bark BK.

Number of yards for COM fabric:

Code	Total	Backrest	Seat	Frame
3020FBW	7.5	2.5	1.75	3.5

Options

Double Stitching

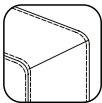

\$0

Prices

Code	GRA	GR1	COM GR2	GR3	GR4	GR5	GR6	GR7	GR8	GR9	GR10	GR11	GR12	Cuir Leather
3020FBW	2857	2981	3146	3311	3517	3724	3930	4136	4342	4549	4755	5167	5580	5236

How to Order

		+	Finishes <i>See the Logiflex Color Guide</i>	Fabric <i>See the Logiflex Graded-in List</i>		
SS	3020FBW	PQD PQS (std)				
series	code	top stitch	leg color	supplier	pattern	color
Example SS	3020FBW	PQS	BK	ENNIS	LOFT	AQUA

Soft Seating

Flint - Sofa

3030FBW

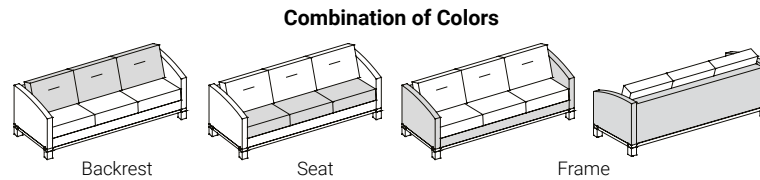
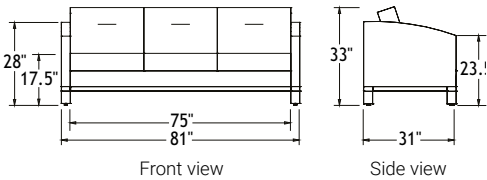
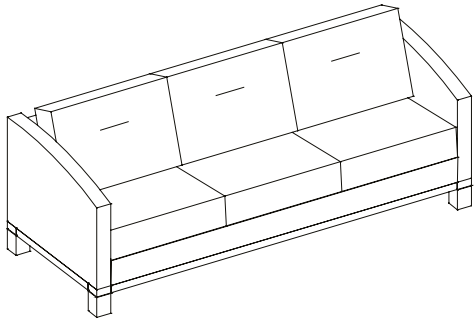

Manufacturing Standards

- Wooden base FBW with 4 legs;
- Single top stitching;
- 9 GA springs for the seat and 11 GA for the backrest;
- Medium-density foam on seat and backrest;
- Firm density foam on the top of the armrests;
- Frame made out of recycled materials and hardwood for seating base.

Wood finishes: Available colors: White Wash WW, Golden Wheat GW, Sand SD, Apricot AT, Pecan PN, Brandy BR, Chestnut CT, Coffee CF, Espresso ES, Bordeaux BO, Black Wash BW and Bark BK.

Number of yards for COM fabric:

Code	Total	Backrest	Seat	Frame
3030FBW	10.25	3.5	2.75	4.25

Options

Double Stitching

\$0

Prices

Code	GRA	GR1	COM	GR2	GR3	GR4	GR5	GR6	GR7	GR8	GR9	GR10	GR11	GR12	Cuir Leather
3030FBW	3639	3808	4034	4259	4541	4823	5105	5387	5668	5950	6232	6796	7360	6890	

How to Order

SS	3030FBW	PQD PQS (std)	Finishes See the Logiflex Color Guide	Fabric See the Logiflex Graded-in List			
series	code	top stitch	leg color	supplier	pattern	color	
Example	SS	3030FBW	PQS	BK	ENNIS	LOFT	AQUA

Soft Seating

Magog - Armchair

MAG

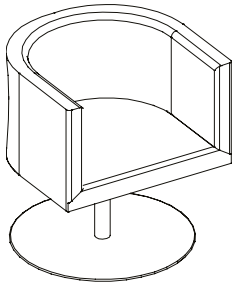

Manufacturing Standards

- 180° swivel armchair that returns to its initial position;
- Single top stitching;
- Medium-density foam;
- Circular base (24" diameter) with glides.

Combination of Colors

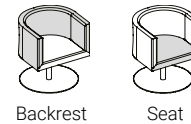

Number of yards for COM fabric:

Code	Total	Backrest	Seat
MAG	4.25	3.25	1

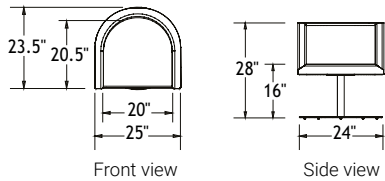

														COM		Cuir
Code	GRA	GR1	GR2	GR3	GR4	GR5	GR6	GR7	GR8	GR9	GR10	GR11	GR12	Leather		
MAG SN	2388	2458	2552	2645	2762	2879	2996	3113	3229	3346	3463	3697	3931	3736		
MAG BL	2388	2458	2552	2645	2762	2879	2996	3113	3229	3346	3463	3697	3931	3736		
MAG CHR	3192	3262	3356	3449	3566	3683	3800	3917	4033	4150	4267	4501	4735	4540		

How to Order

SS	MAG	BL SN CHR	Fabric <i>See the Logiflex Graded-in List</i>		
series	code	base	supplier	pattern	color

Example SS MAG CHR ENNIS LOFT AQUA

Soft Seating

Orford - Armchair

ORF

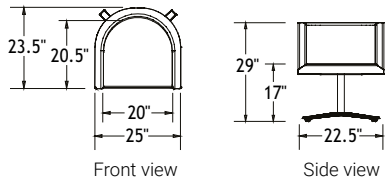
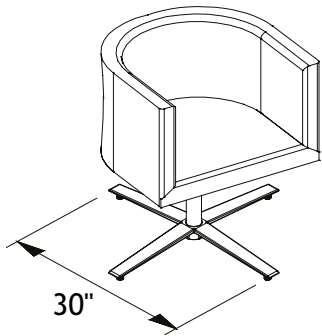

Combination of Colors

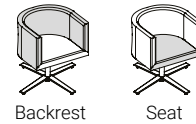

Manufacturing Standards

- 180° swivel armchair that returns to its initial position;
- Single top stitching;
- Medium-density foam;
- Aluminum base with glides;
- Footing dimension: 30" wide.

Number of yards for COM fabric:

Code	Total	Backrest	Seat
ORF	4.25	3.25	1

Prices														
Code	GRA	GR1	COM GR2	GR3	GR4	GR5	GR6	GR7	GR8	GR9	GR10	GR11	GR12	Cuir Leather
ORF SN	2990	3060	3154	3247	3364	3481	3598	3715	3831	3948	4065	4299	4533	4338
ORF BL	2990	3060	3154	3247	3364	3481	3598	3715	3831	3948	4065	4299	4533	4338
ORF CHR	3541	3611	3705	3798	3915	4032	4149	4266	4382	4499	4616	4850	5084	4889

How to Order

SS	ORF	BL SN CHR	Fabric <i>See the Logiflex Graded-in List</i>		
series	code	base	supplier	pattern	color

Example SS ORF CHR ENNIS LOFT AQUA

Soft Seating

Stelli - Armchair

6750

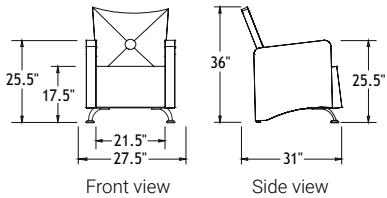
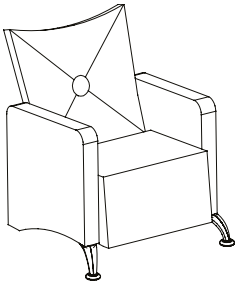

Combination of Colors

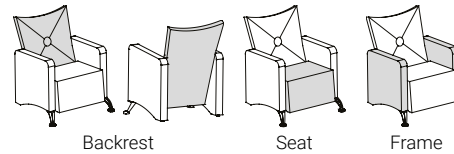

Manufacturing Standards

- 2 metal legs PM (brushed nickel finish) in front and 2 levelers in the back;
- Single top stitching;
- Elastic straps on seat and back;
- Medium-density foam on seat and backrest;
- Firm density foam on the top of the armrests;
- Standard button and "X" stitch in the backrest;
- Frame made out of recycled materials.

Wooden Legs option: 2 wooden legs, WL, 3" x 3" x 3-3/4" with levelers, choice of Logiflex wood finishes.

No Button: option to remove the button and the decorative "X" on the backrest.

Pivoting Shelf: 20" x 11-5/8" pivoting shelf of 3/4" hardwood.

Wood finishes: Available colors: White Wash WW, Golden Wheat GW, Sand SD, Apricot AT, Pecan PN, Brandy BR, Chestnut CT, Coffee CF, Espresso ES, Bordeaux BO, Black Wash BW and Bark BK.

Number of yards for COM fabric:

Code	Total	Backrest	Seat	Frame
6750	4,25	2,25	1,25	3,25

Options

2 Wooden Legs WL \$ 42 ea.	Double Stitching \$0	No Button SBX \$0	Pivoting Shelf Left SPL \$347	Right SPR \$347
--	------------------------------------	---	--	----------------------------------

Prices

Code	GRA	GR1	COM GR2	GR3	GR4	GR5	GR6	GR7	GR8	GR9	GR10	GR11	GR12	Cuir Leather
6750 PM	1867	1937	2031	2124	2241	2358	2475	2592	2708	2825	2942	3176	3410	3215
6750 WL	1967	2037	2131	2224	2341	2458	2575	2692	2808	2925	3042	3276	3510	3315

How to Order

SS	6750	WL PM (std)	PQD PQS (std)	SBX	SPL SPR	Fabric <i>See the Logiflex Graded-in List</i>		
series	code	legs	top stitch	no button	pivoting shelf	supplier	pattern	color
Example	SS	6750	PM	PQS		ENNIS	LOFT	AQUA

Soft Seating

Stelli - Loveseat

6753

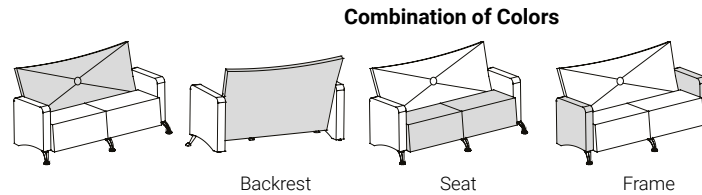
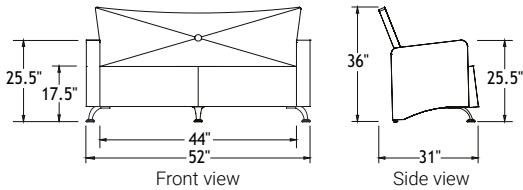
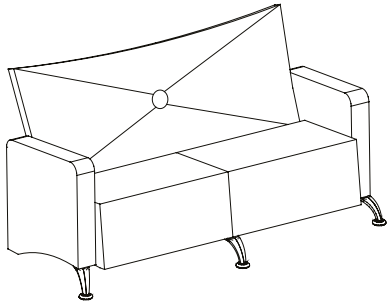

Manufacturing Standards

- 3 metal legs PM (brushed nickel finish) in front and 2 levelers in the back;
- Single top stitching;
- Elastic straps on seat and back;
- Medium-density foam on seat and backrest;
- Firm density foam on the top of the armrests;
- Standard button and "X" stitch in the backrest;
- Frame made out of recycled materials.

Wooden Legs option: 3 wooden legs, WL, 4" x 4" x 3-3/4" levelers, choice of Logiflex wood finishes.

No Button: option to remove the button and the decorative "X" on the backrest.

Pivoting Shelf: 20" x 11-5/8" pivoting shelf of 3/4" hardwood.

Wood finishes: Available colors: White Wash WW, Golden Wheat GW, Sand SD, Apricot AT, Pecan PN, Brandy BR, Chestnut CT, Coffee CF, Espresso ES, Bordeaux BO, Black Wash BW and Bark BK.

Number of yards for COM fabric:

Code	Total	Backrest	Seat	Frame
6753	6.75	4	1.75	3.5

Options

2 Wooden Legs	Double Stitching	No Button	Pivoting Shelf	
			Left	Right
WL \$ 42 ea.	\$0	SBX \$0	SPL \$347	SPR \$347

Prices

Code	COM												Cuir Leather	
	GRA	GR1	GR2	GR3	GR4	GR5	GR6	GR7	GR8	GR9	GR10	GR11		GR12
6753 PM	2585	2696	2845	2993	3179	3364	3550	3736	3921	4107	4292	4664	5035	4726
6753 WL	2732	2843	2992	3140	3326	3511	3697	3883	4068	4254	4439	4811	5182	4873

How to Order

SS	6753	WL PM (std)	PQS (std)	SBX	SPL SPR	Fabric <i>See the Logiflex Graded-in List</i>		
series	code	legs	top stitch	no button	pivoting shelf	supplier	pattern	color
Example	SS	6753	PM	PQS		ENNIS	LOFT	AQUA

Soft Seating

Stelli - Sofa

6757

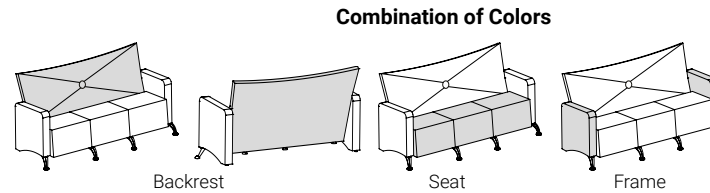
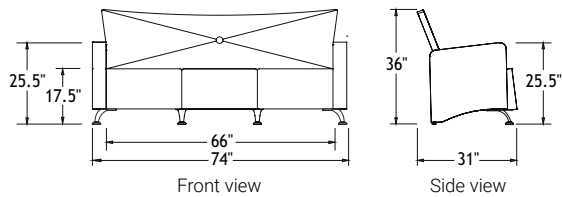
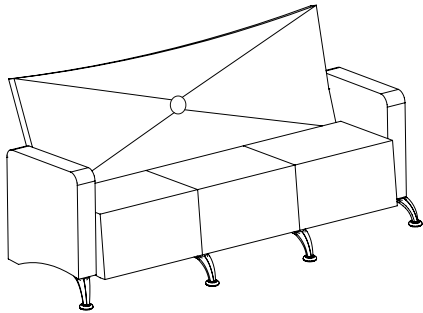

Manufacturing Standards

- 4 metal legs PM (brushed nickel finish) in front and 2 levelers in the back;
- Single top stitching;
- Elastic straps on seat and back;
- Medium-density foam on seat and backrest;
- Firm density foam on the top of the armrests;
- Standard button and "X" stitch in the backrest;
- Frame made out of recycled materials.

Wooden Legs option: 4 wooden legs, WL, 4" x 4" x 3-3/4" levelers, choice of Logiflex wood finishes.

No Button: option to remove the button and the decorative "X" on the backrest.

Pivoting Shelf: 20" x 11-5/8" pivoting shelf of 3/4" hardwood.

Wood finishes: Available colors: White Wash WW, Golden Wheat GW, Sand SD, Apricot AT, Pecan PN, Brandy BR, Chestnut CT, Coffee CF, Espresso ES, Bordeaux BO, Black Wash BW and Bark BK.

Number of yards for COM fabric:

Code	Total	Backrest	Seat	Frame
6757	10	5.5	2.5	3.5

Options

2 Wooden Legs WL \$ 42 ea.	Double Stitching \$0	No Button SBX \$0	Pivoting Shelf Left SPL \$347	Right SPR \$347
--	------------------------------------	---	--	----------------------------------

Prices

Code	GRA	GR1	COM GR2	GR3	GR4	GR5	GR6	GR7	GR8	GR9	GR10	GR11	GR12	Cuir Leather
6757 PM	3090	3255	3475	3695	3970	4245	4520	4795	5070	5345	5620	6170	6720	6262
6757 WL	3299	3464	3684	3904	4179	4454	4729	5004	5279	5554	5829	6379	6929	6471

How to Order

SS	6757	WL PM (std)	PQS (std)	SBX	SPL SPR	Fabric <i>See the Logiflex Graded-in List</i>		
series	code	legs	top stitch	no button	pivoting shelf	supplier	pattern	color
Example SS	6757	PM	PQS			ENNIS	LOFT	AQUA

Soft Seating

Stelli - Armchair

6759

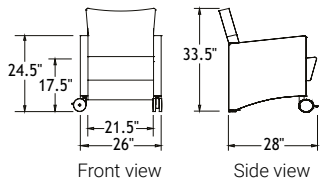
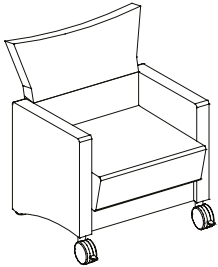

Manufacturing Standards

- 2 standard wheels in front and 2 levelers in the back;
- Single top stitching;
- Elastic straps on seat;
- Medium-density foam on seat and backrest;
- Firm density foam on top of the arms of the chair;
- Fabric handle in the top of the back;
- Frame made out of recycled materials.

Combination of Colors

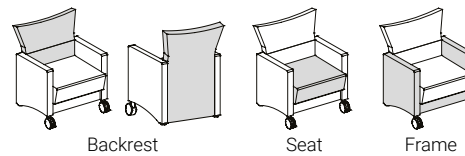

Number of yards for COM fabric:

Code	Total	Backrest	Seat	Frame
6759	4.25	2.25	1.25	3

Options

Double Stitching

\$0

Prices

Code	GRA	GR1	COM GR2	GR3	GR4	GR5	GR6	GR7	GR8	GR9	GR10	GR11	GR12	Cuir Leather
6759	1474	1544	1638	1731	1848	1965	2082	2199	2315	2432	2549	2783	3017	2822

How to Order

SS	6759	PQD PQS (std)	Fabric <i>See the Logiflex Graded-in List</i>		
series	code	top stitch	supplier	pattern	color
Example SS	6759	PQS	ENNIS	LOFT	AQUA

Soft Seating

Taylor - Armchair

TAY1

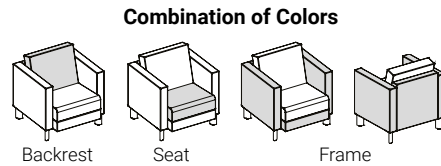
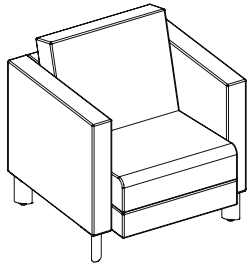

Manufacturing Standards

- Elastic straps on seat;
- Medium-density foam;
- Frame made out of recycled and recyclable particles;
- Oval metal legs 6" H, satin nickel finish.

Number of yards for COM fabric:

Code	Total	Backrest	Seat	Frame
TAY1	4	1	1	3.5

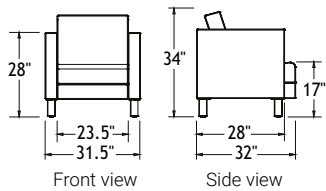

Prices

Code	GRA	GR1	COM GR2	GR3	GR4	GR5	GR6	GR7	GR8	GR9	GR10	GR11	GR12	Cuir Leather
TAY1	1341	1407	1495	1583	1693	1803	1913	2023	2133	2243	2353	2573	2793	2610

How to Order

Fabric

See the Logiflex Graded-in List

SS	TAY1			
series	code	supplier	pattern	color

Example

SS	TAY1	ENNIS	LOFT	AQUA
----	------	-------	------	------

Soft Seating

Taylor - Loveseat

TAY2

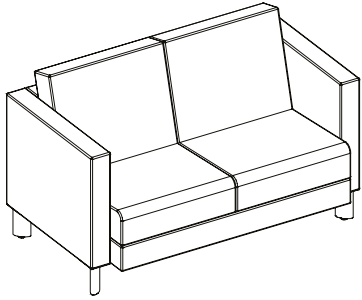

Combination of Colors

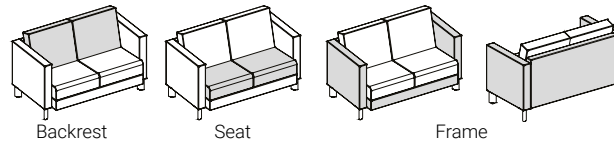

Manufacturing Standards

- Elastic straps on seat;
- Medium-density foam;
- Frame made out of recycled and recyclable particles;
- Oval metal legs 6" H, satin nickel finish.

Number of yards for COM fabric:

Code	Total	Backrest	Seat	Frame
TAY2	5.5	1.5	1.5	5

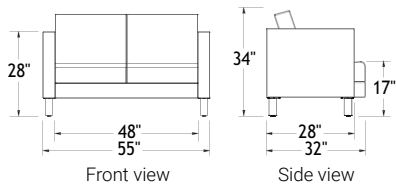

Prices														
Code	GRA	GR1	COM GR2	GR3	GR4	GR5	GR6	GR7	GR8	GR9	GR10	GR11	GR12	Cuir Leather
TAY2	1868	1959	2080	2201	2352	2504	2655	2806	2957	3109	3260	3562	3865	3613

How to Order

Fabric

[See the Logiflex Graded-in List](#)

SS	TAY2			
series	code	supplier	pattern	color

Example SS TAY2 ENNIS LOFT AQUA

Soft Seating

Taylor - Sofa

TAY3

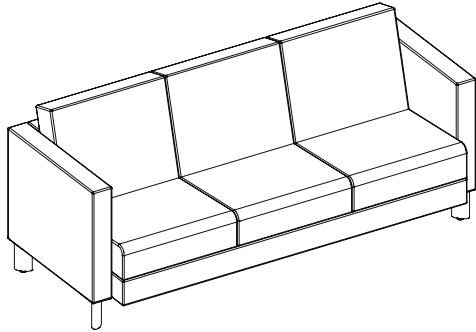

Combination of Colors

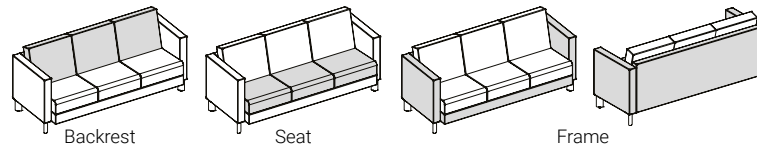

Manufacturing Standards

- Elastic straps on seat;
- Medium-density foam;
- Frame made out of recycled and recyclable particles;
- Oval metal legs 6" H, satin nickel finish.

Number of yards for COM fabric:

Code	Total	Backrest	Seat	Frame
TAY3	9	2	2.25	7

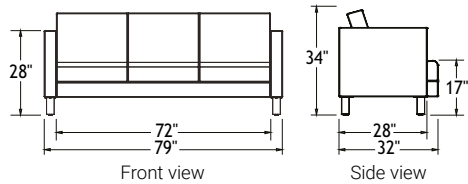

Prices															
Code	GRA	GR1	COM	GR2	GR3	GR4	GR5	GR6	GR7	GR8	GR9	GR10	GR11	GR12	Cuir Leather
TAY3	2457	2606	2804	3002	3250	3497	3745	3992	4240	4487	4735	5230	5725	5312	

How to Order

Fabric

[See the Logiflex Graded-in List](#)

SS	TAY3			
series	code	supplier	pattern	color

Example SS TAY3 ENNIS LOFT AQUA

Soft Seating

Slim - Lounge Armchair

SL1AB

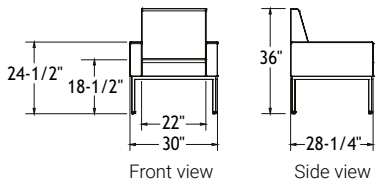
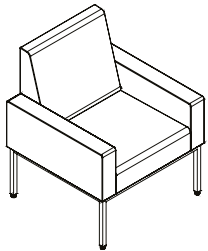

Combination of Colors

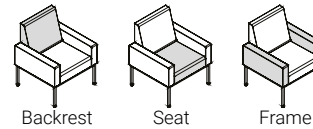

Manufacturing Standards

- Construction in laminated hardwood veneer and hardwood;
- Springs on seat covered with 2" foam and 1/2" polyester;
- Elastic straps on back covered with 1-1/2" foam and 1/2" polyester;
- Arms covered with 1" foam;
- Seating frame base with four 11" high legs in 1" square welded steel profile. On white nylon levelers;
- Single top stitching.

Metal finishes available in satin nickel (SN) and black (BL).

Number of yards for COM fabric:

Code	Total	Backrest	Seat	Frame
SL1AB	3	1.5	1	1.5

Options

Double Stitching

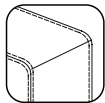

\$0

Prices

Code	GRA	GR1	COM GR2	GR3	GR4	GR5	GR6	GR7	GR8	GR9	GR10	GR11	GR12	Cuir Leather
SL1AB	1869	1919	1985	2051	2134	2216	2299	2381	2464	2546	2629	2794	2959	2821

How to Order

SS	SL1AB	BL SN (std)	PQD PQS (std)	Fabric <i>See the Logiflex Graded-in List</i>			
series	code	metal finish (Appx. A)	top stitching	supplier	pattern	color	
Example	SS	SL1AB	SN	PQS	ENNIS	LOFT	AQUA

Soft Seating

Slim - Loveseat

SL2AB

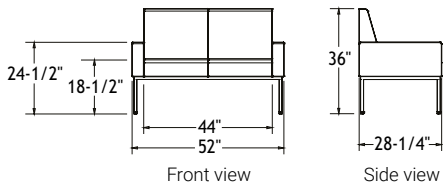
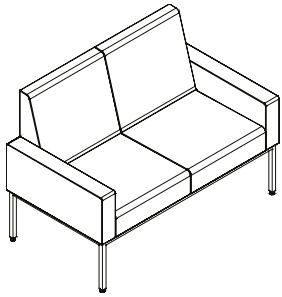

Combination of Colors

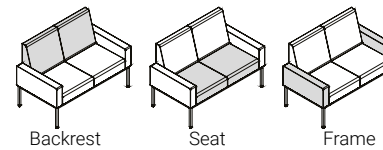

Manufacturing Standards

- Construction in laminated hardwood veneer and hardwood;
- Springs on seat covered with 2" foam and 1/2" polyester;
- Elastic straps on back covered with 1-1/2" foam and 1/2" polyester;
- Arms covered with 1" foam;
- Seating frame base with four 11" high legs in 1" square welded steel profile. On white nylon levelers;
- Single top stitching.

Metal finishes available in satin nickel (SN) and black (BL).

Number of yards for COM fabric:

Code	Total	Backrest	Seat	Frame
SL2AB	4,75	2	1,25	1,5

Options

Double Stitching

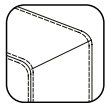

\$0

Prices

Code	GRA	GR1	COM GR2	GR3	GR4	GR5	GR6	GR7	GR8	GR9	GR10	GR11	GR12	Cuir Leather
SL2AB	2680	2758	2863	2967	3098	3228	3359	3490	3620	3751	3881	4143	4404	4186

How to Order

SS	SL2AB	BL SN (std)	PQD PQS (std)	Fabric <i>See the Logiflex Graded-in List</i>			
series	code	metal finish (Appx. A)	top stitching	supplier	pattern	color	
Example	SS	SL2AB	SN	PQS	ENNIS	LOFT	AQUA

Soft Seating

Slim - Sofa

SL3AB

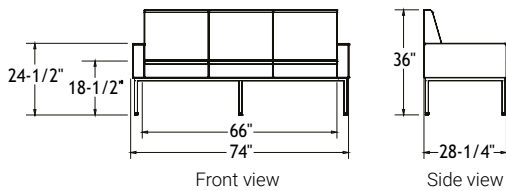
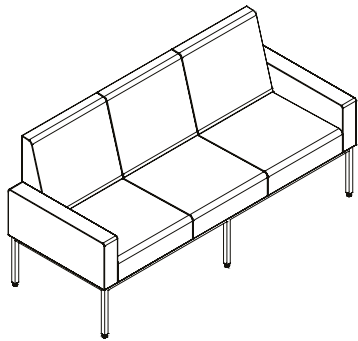

Combination of Colors

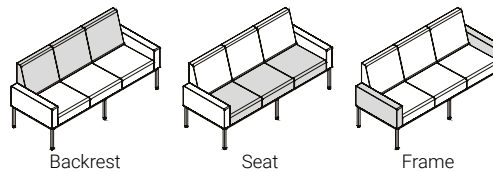

Manufacturing Standards

- Construction in laminated hardwood veneer and hardwood;
- Springs on seat covered with 2" foam and 1/2" polyester;
- Elastic straps on back covered with 1-1/2" foam and 1/2" polyester;
- Arms covered with 1" foam;
- Seating frame base with six 11" high legs in 1" square welded steel profile. On white nylon levelers;
- Single top stitching.

Metal finishes available in satin nickel (SN) and black (BL).

Number of yards for COM fabric:

Code	Total	Backrest	Seat	Frame
SL3AB	7	3,5	2	1,5

Options

Double Stitching

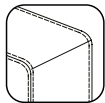

\$0

Prices

Code	GRA	GR1	COM GR2	GR3	GR4	GR5	GR6	GR7	GR8	GR9	GR10	GR11	GR12	Cuir Leather
SL3AB	3446	3562	3716	3870	4063	4255	4448	4640	4833	5025	5218	5603	5988	5667

How to Order

SS	SL3AB	BL SN (std)	PQD PQS (std)	Fabric <i>See the Logiflex Graded-in List</i>			
series	code	metal finish (Appx. A)	top stitching	supplier	pattern	color	
Example	SS	SL3AB	SN	PQS	ENNIS	LOFT	AQUA

Soft Seating

Slim - Lounge Chair

SL1SB

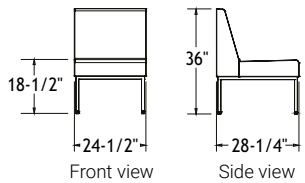
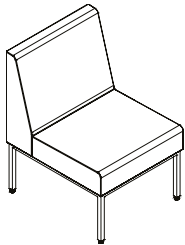

Combination of Colors

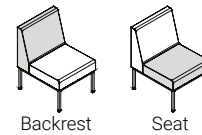

Manufacturing Standards

- Construction in laminated hardwood veneer and hardwood;
- Springs on seat covered with 2" foam and 1/2" polyester;
- Elastic straps on back covered with 1-1/2" foam and 1/2" polyester;
- Seating frame base with four 11" high legs in 1" square welded steel profile. On white nylon levelers;
- Single top stitching.

Metal finishes available in satin nickel (SN) and black (BL).

Number of yards for COM fabric:

Code	Total	Backrest	Seat
SL1SB	2	1.5	1

Options

Double Stitching

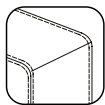

\$0

Prices

Code	GRA	GR1	COM GR2	GR3	GR4	GR5	GR6	GR7	GR8	GR9	GR10	GR11	GR12	Cuir Leather
SL1SB	1507	1540	1584	1628	1683	1738	1793	1848	1903	1958	2013	2123	2233	2141

How to Order

SS	SL1SB	BL SN (std)	PQD PQS (std)	Fabric <i>See the Logiflex Graded-in List</i>			
series	code	metal finish (Appx. A)	top stitching	supplier	pattern	color	
Example	SS	SL1SB	SN	PQS	ENNIS	LOFT	AQUA

Soft Seating

Slim - Armless Loveseat

SL2SB

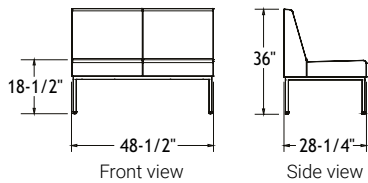
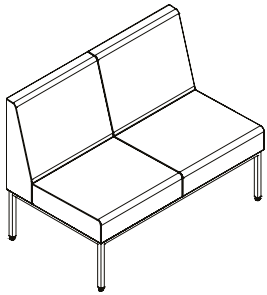

Combination of Colors

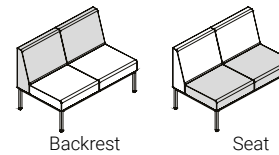

Manufacturing Standards

- Construction in laminated hardwood veneer and hardwood;
- Springs on seat covered with 2" foam and 1/2" polyester;
- Elastic straps on back covered with 1-1/2" foam and 1/2" polyester;
- Seating frame base with four 11" high legs in 1" square welded steel profile. On white nylon levelers;
- Single top stitching.

Metal finishes available in satin nickel (SN) and black (BL).

Number of yards for COM fabric:

Code	Total	Backrest	Seat
SL2SB	3.25	2	1.25

Options

Double Stitching

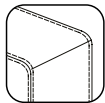

\$0

Prices

Code	GRA	GR1	COM GR2	GR3	GR4	GR5	GR6	GR7	GR8	GR9	GR10	GR11	GR12	Cuir Leather
SL2SB	2291	2345	2417	2488	2577	2667	2756	2846	2935	3024	3114	3292	3471	3322

How to Order

SS	SL2SB	BL SN (std)	PQD PQS (std)	Fabric <i>See the Logiflex Graded-in List</i>			
series	code	metal finish (Appx. A)	top stitching	supplier	pattern	color	
Example	SS	SL2SB	SN	PQS	ENNIS	LOFT	AQUA

Soft Seating

Slim - Armless Sofa

SL3SB

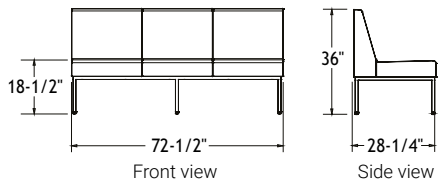
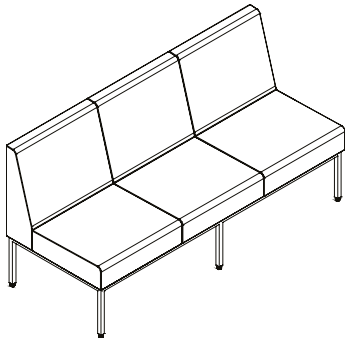

Combination of Colors

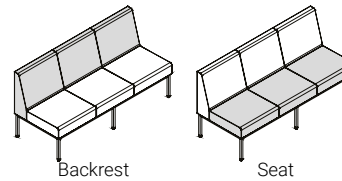

Manufacturing Standards

- Construction in laminated hardwood veneer and hardwood;
- Springs on seat covered with 2" foam and 1/2" polyester;
- Elastic straps on back covered with 1-1/2" foam and 1/2" polyester;
- Seating frame base with six 11" high legs in 1" square welded steel profile. On white nylon levelers;
- Single top stitching.

Metal finishes available in satin nickel (SN) and black (BL).

Number of yards for COM fabric:

Code	Total	Backrest	Seat
SL3SB	5.5	3.5	2

Options

Double Stitching

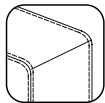

\$0

Prices

Code	GRA	GR1	COM GR2	GR3	GR4	GR5	GR6	GR7	GR8	GR9	GR10	GR11	GR12	Cuir Leather
SL3SB	3101	3192	3313	3434	3585	3737	3888	4039	4190	4342	4493	4795	5098	4846

How to Order

SS	SL3SB	BL SN (std)	PQD PQS (std)	Fabric <i>See the Logiflex Graded-in List</i>			
series	code	metal finish (Appx. A)	top stitching	supplier	pattern	color	
Example	SS	SL3SB	SN	PQS	ENNIS	LOFT	AQUA

Soft Seating

Slim - Small Coffee Table

SL1T

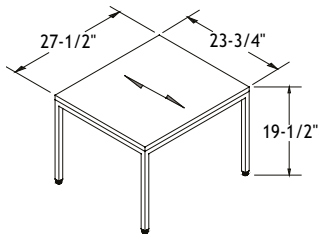

Manufacturing Standards

- 1" rectangular laminate top;
- Table frame base with four 18" high legs in 1" square welded steel profile.
- On white nylon levelers;
- Height: 19.5".

Metal finishes available in satin nickel (SN) and black (BL).

Prices

Code	
SL1T	569

How to Order

OS	SL1T	BL SN (std)
series	code	metal finish (Appx. A)

Example OS SL1T SN

Soft Seating

Slim - Large Coffee Table

SL2T

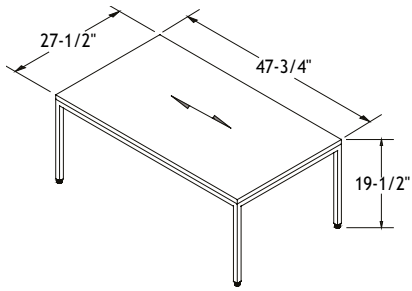

Manufacturing Standards

- 1" rectangular laminate top;
- Table frame base with four 18" high legs in 1" square welded steel profile.
- On white nylon levelers;
- Height: 19.5".

Metal finishes available in satin nickel (SN) and black (BL).

Prices

Code	
SL2T	713

How to Order

OS	SL2T	BL SN (std)
series	code	metal finish (Appx. A)

Example OS SL2T SN

Chairs

Appendix - MADRID - Options

Back Height



L Low back



M Medium back

Structure

UW wooden shell with seat cushion

UU fully upholstered chair

WW wooden shell

US HPL shell with seat cushion

SS HPL shell

Base



04 4 legs



T424 Stool 24"H
T429 Stool 29"H

Legs



G Glides



T Teflon glide
\$39

Metal



BL Black



CHR Chrome

Wood



GW Golden Wheat

HPL



W Polar White



B Jet Black

Chairs

Madrid - High Back - Wood or Upholstered

MD - MUW

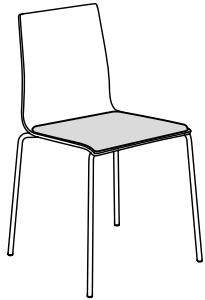

MD - MUU

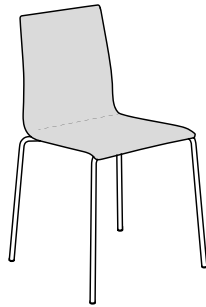

MD - MWW

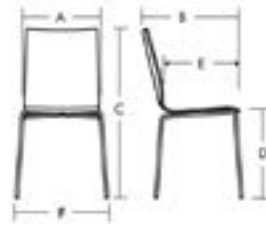

A Backrest width	15,75"
B Chair depth	20,5"
C Chair height	35"
D Seat height	18,75"
E Seat depth	16,5"
F Chair width	19,5"

Manufacturing Standards

Madrid chair:

- Wooden shell, golden wheat finish (GW),
 - MD-MUW: wooden shell with seat cushion;
 - MD-MUU: fully upholstered chair;
 - MD-MWW: wooden shell;
- Metal base with 4 legs, Black (BL) or Chrome (CHR) finish,
- Base on glides:
 - glides (G) or Teflon glides (T)
- Stackable up to 10 (using a trolley);
- Weight and volume (for 3 chairs): 35 lbs / 16 ft³;

SFP option: Plastic protector fixed under the seat to protect the fabric when the chairs are stacked.

Compatible with the **XO-10** trolley for stacking chairs.

Fabric finishes: Selection of fabrics or vinyl by the customer from the supplier of their choice.

Number of yards for COM fabric:

Code	Total
UW	0,62
UU	1,5

Options

Protector



SFP
\$28

Legs



G
\$0

T
\$39

Prices

MD

Code	COM													Cuir
	GRA	GR1	GR2	GR3	GR4	GR5	GR6	GR7	GR8	GR9	GR10	GR11	GR12	Leather
UW	629	638	648	655	666	677	689	699	710	722	733	755	777	721
UU	647	670	700	732	769	807	846	883	922	960	998	1076	1152	1128

MD - Wood

Code	
WW	534

How to Order

Combination of Colors

Fabrics
See the fabric chart
Logiflex grade

LC	MD	M	UW UU WW	04	G T	BL CHR	GW	SFP		
serie	code	Back height	Structure	Base	Legs	Metal finish	Wood finish	Protector		
Example	LC	MD	M	UW	04	G	BL	GW	ENNIS LOFT AQUA	SFP

Chairs

Madrid - High Back - HPL

MD - MUS

MD - MSS

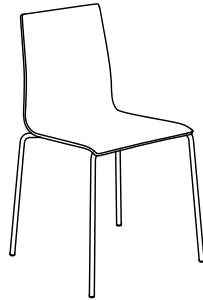

A Backrest width	15,75"
B Chair depth	20,5"
C Chair height	35"
D Seat height	18,75"
E Seat depth	16,5"
F Chair width	19,5"

Manufacturing Standards

Madrid chair:

- HPL shell, Intense Black (B) or Polar White (W) finish,
 - MD-MUS: HPL shell with seat cushion
 - MD-MSS: HPL shell
- Metal base with 4 legs, Black (BL) or Chrome (CHR) finish,
- Base on glides:
 - glides (G) or Teflon glides (T)
- Stackable up to 10 (using a trolley);
- Weight and volume (for 3 chairs): 35 lbs / 16 ft³;

SFP option: Plastic protector fixed under the seat to protect the fabric when the chairs are stacked.

Compatible with the **XO-10** trolley for stacking chairs.

Fabric finishes: Selection of fabrics or vinyl by the customer from the supplier of their choice.

Number of yards for COM fabric:

Code	Total
US	0,62

Options

Protector

Chair options



SFP

See [Appendix Madrid](#) for complete options

Prices

MD

Code	GRA	GR1	COM GR2	GR3	GR4	GR5	GR6	GR7	GR8	GR9	GR10	GR11	GR12	Cuir Leather
US	741	752	760	769	780	792	802	814	824	835	847	868	891	834

MD - HPL

Code	
SS	648

How to Order

Combination of Colors

Fabrics

See the fabric chart
Logiflex grade

LC	MD	M	US SS	04	G T	BL CHR	W B	Supplier	Pattern	Color	SFP	
serie	code	Back height	Structure	Base	Legs	Metal finish	HPL finish				Protector	
Example	LC	MD	M	SS	04	G	BL	W	ENNIS	LOFT	AQUA	SFP

Chairs

Madrid - Stool (24") Counter Height - Wood or Upholstered

MD - LUW



MD - LUU

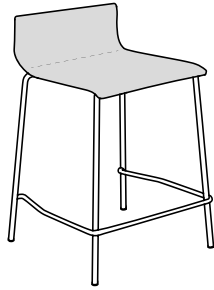

MD - LWW

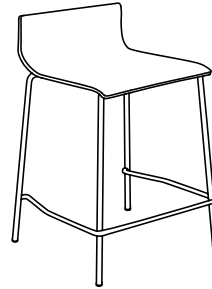

A Backrest width	15,75"
B Chair depth	18,75"
C Chair height	33,5"
D Seat height	24"
E Seat depth	16"
F Chair width	19,5"

Manufacturing Standards

Madrid stool, counter height (24"H):

- Wooden shell, golden wheat finish (GW),
 - MD-LUW: wooden shell with seat cushion
 - MD-LUU: fully upholstered chair;
 - MD-LWW: wooden shell
- Metal base with 4 legs, Black (BL) or Chrome (CHR) finish,
- Base on glides:
 - glides (G) or Teflon glides (T)
- Weight and volume (for 3 chairs): 25 lbs / 8 ft³;

Fabric finishes: Selection of fabrics or vinyl by the customer from the supplier of their choice.

Number of yards for COM fabric:

Code	Total
UW	0,62
UU	1,2

Options

Chair options



See [Appendix Madrid](#) for complete options

Prices

MD

Code	COM													Cuir Leather
	GRA	GR1	GR2	GR3	GR4	GR5	GR6	GR7	GR8	GR9	GR10	GR11	GR12	
UW	869	877	888	895	905	919	928	939	950	963	972	994	1018	961
UU	825	842	867	891	921	950	980	1011	1041	1070	1101	1161	1221	1250

MD - Wood

Code
WW
774

How to Order

Combination of Colors

Fabrics
See the fabric chart
Logiflex grade

LC	MD	L	UW UU WW	T424	G T	BL CHR	GW	supplier	pattern	color
serie	code	Back height	Structure	Base	Legs	Metal finish	Wood finish			

Example LC - MD - L UW - T424 - G - BL - GW - ENNIS LOFT AQUA

Chairs

Madrid - Stool (29"H) Bar Height - Wood or upholstered

MD - LUW

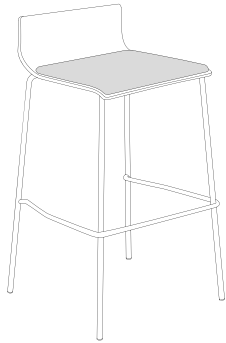

MD - LUU

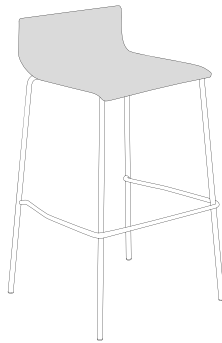

MD - LWW

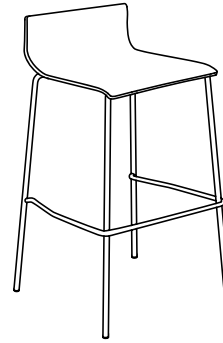

A Backrest width	15,75"
B Chair depth	18,75"
C Chair height	38,5"
D Seat height	29"
E Seat depth	16"
F Chair width	19,5"

Manufacturing Standards

Madrid stool, bar height (29"H):

- Wooden shell, golden wheat finish (GW),
 - MD-LUW: wooden shell with seat cushion
 - MD-LUU: fully upholstered chair;
 - MD-LWW: wooden shell
- Metal base with 4 legs, Black (BL) or Chrome (CHR) finish,
- Base on glides:
 - glides (G) or Teflon glides (T)
- Weight and volume (for 3 chairs): 25 lbs / 8 ft³;
- Use with a 42"H top.

Fabric finishes: Selection of fabrics or vinyl by the customer from the supplier of their choice.

Number of yards for COM fabric:

Code	Total
UW	0,62
UU	1,2

Options

Chair options



See [Appendix Madrid](#) for complete options

Prices

MD

Code	COM													Cuir Leather
	GRA	GR1	GR2	GR3	GR4	GR5	GR6	GR7	GR8	GR9	GR10	GR11	GR12	
UW	869	877	888	895	905	919	928	939	950	963	972	994	1018	961
UU	825	842	867	891	921	950	980	1011	1041	1070	1101	1161	1221	1250

MD - Wood

Code	
WW	774

How to Order

Combination of Colors

Fabrics
See the fabric chart
Logiflex grade

LC	-	MD	-	L	-	T429	-	G	-	BL	-	GW	-						
serie		code		Back height		Base		Legs		Metal finish		Wood finish		supplier	pattern	color			
Example	LC	-	MD	-	L	-	UW	-	T429	-	G	-	BL	-	GW	-	ENNIS	LOFT	AQUA

Chairs

Madrid - Stool (24"H) Counter Height - HPL

MD - LUS

MD - LSS

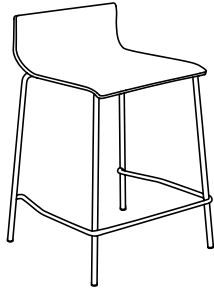

A Backrest width	15,75"
B Chair depth	18,75"
C Chair height	33,5"
D Seat height	24"
E Seat depth	16"
F Chair width	19,5"

Manufacturing Standards

Madrid stool, counter height (24"H):

- HPL shell, Intense Black (B) or Polar White (W) finish,
 - MD-LUS: HPL shell with seat cushion
 - MD-LSS: HPL shell
- Metal base with 4 legs, Black (BL) or Chrome (CHR) finish,
- Base on glides:
 - glides (G) or Teflon glides (T)
- Weight and volume (for 3 chairs): 25 lbs / 8 ft³;

Fabric finishes: Selection of fabrics or vinyl by the customer from the supplier of their choice.

Number of yards for COM fabric:

Code	Total
US	0,62

Options

Chair options



See [Appendix Madrid](#) for complete options

Prices

MD

Code	GRA	GR1	COM GR2	GR3	GR4	GR5	GR6	GR7	GR8	GR9	GR10	GR11	GR12	Cuir Leather
US	975	986	994	1001	1014	1024	1036	1046	1058	1068	1081	1101	1124	1067

MD - HPL

Code	
SS	881

How to Order

Combination of Colors

Fabrics
See the fabric chart
Logiflex grade

LC	-	MD	-	L	US	-	T424	-	G	-	BL	-	W	-	Supplier	Pattern	Color
serie		code		Back height	Structure		Base		Legs		Metal finish		HPL finish				
					SS				T		CHR		B				

Example LC - MD - L SS - T424 - G - BL - W - ENNIS LOFT AQUA

Chairs

Madrid - Stool (29"H) Bar Height - HPL

MD - LUS

MD - LSS

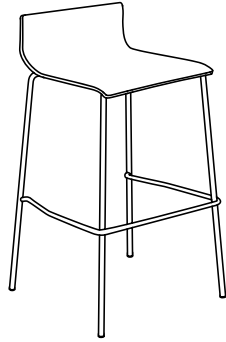
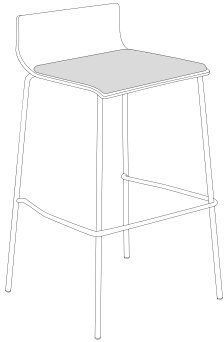

A Backrest width	15,75"
B Chair depth	18,75"
C Chair height	38,5"
D Seat height	29"
E Seat depth	16"
F Chair width	19,5"

Manufacturing Standards

Madrid stool, bar height (29"H):

- HPL shell, Intense Black (B) or Polar White (W) finish,
 - MD-LUS: HPL shell with seat cushion
 - MD-LSS: HPL shell
- Metal base with 4 legs, Black (BL) or Chrome (CHR) finish,
- Base on glides:
 - glides (G) or Teflon glides (T)
- Weight and volume (for 3 chairs): 25 lbs / 8 ft³,
- Use with a 42"H top.

Fabric finishes: Selection of fabrics or vinyl by the customer from the supplier of their choice.

Number of yards for COM fabric:

Code	Total
US	0,62

Options

Chair options



See [Appendix Madrid](#) for complete options

Prices

MD

Code	GRA	GR1	COM GR2	GR3	GR4	GR5	GR6	GR7	GR8	GR9	GR10	GR11	GR12	Cuir Leather
US	975	986	994	1001	1014	1024	1036	1046	1058	1068	1081	1101	1124	1067

MD - HPL

Code	
SS	881

How to Order

Combination of Colors

Fabrics
See the fabric chart
Logiflex grade

LC	-	MD	-	L	US	-	T429	-	G	-	BL	-	W	-			
serie		code		Back height	Structure		Base		Legs		Metal finish		HPL finish		supplier	pattern	color

Example LC - MD - L SS - T429 - G - BL - W - ENNIS LOFT AQUA

Chairs

STACK6 - Stackable Chair

S6 - UP

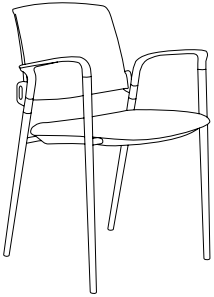

S6 - UU

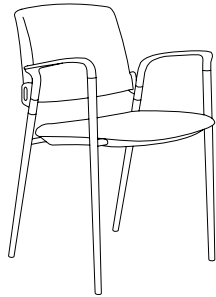

S6 - PP

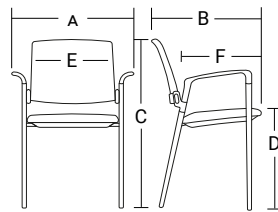
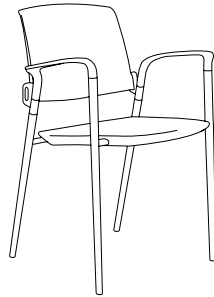

A Chair width	23,5"
B Chair depth	21,5"
C Chair height	31,5"
D Seat height	17,5"
E Backrest width	17"
F Seat depth	17,5"

Manufacturing Standards

Stack6 chair:

- 3 types of chairs:
 - UP: Plastic backrest, padded seat
 - UU: Backrest and padded seats
 - PP: Backrest and seat in plastic
- Seat with cascading edge;
- Black metal base (BL) with chrome details and black polyurethane armrests;
- Non-marking glides;
- Stackable up to 6;
- Weight and volume (for 3 chairs): 45 lbs / 16 ft³;

Plastic finishes: Black (01) or Charcoal (10)

Fabric finishes: Selection of fabrics or vinyl by the customer from the supplier of their choice.

Number of yards for COM fabric:

Code	Total
UP	0,9
UU	0,9

Prices

S6

Code	GRA	GR1	COM GR2	GR3	GR4	GR5	GR6	GR7	GR8	GR9	GR10	GR11	GR12	Cuir Leather
UP	497	513	534	553	580	605	631	657	682	708	734	785	837	773
UU	586	607	635	662	696	732	766	800	834	868	902	971	1040	963

S6 - Plastic

Code	
PP	402

How to Order

Combination of Colors

LC	-	S6	-	UP UU PP	-	04	-	FX	-	G	-	N	-	01 10	-			
serie		code		structure		base		arms		legs		metal finish		plastic finish		supplier	pattern	color

Example

LC	-	S6	-	UU	-	04	-	FX	-	G	-	N	-	10	-	ENNIS	LOFT	AQUA
----	---	----	---	----	---	----	---	----	---	---	---	---	---	----	---	-------	------	------

Chairs



Cart (Madrid - Stack6)

MD-10

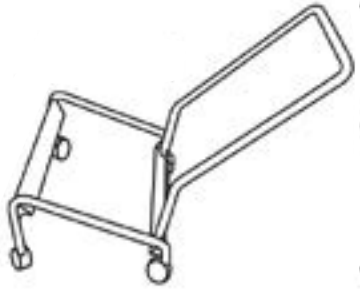

A Chair width	20"
B Chair depth	25"
C Chair height	36"

Manufacturing Standards

Cart (Madrid, Stack6) :

- Cart for stacking chairs.
- Silver painted steel with handle.
- Black casters with brakes.
- 10 stacked chair capacity.

Prices

Code

MD-10 462

How to Order

LC	MD-10
serie	code

Example **LC** **MD-10**

Chairs

Sedia - Chairs

803

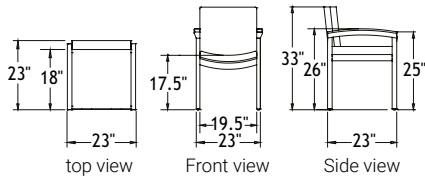
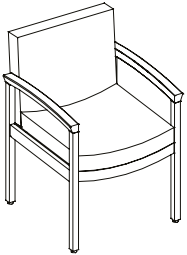

Combination of Colors

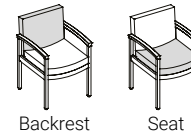

Manufacturing Standards

- Single top stitching;
- Elastic straps on seat and back;
- Medium-density foam on seat;
- Low density foam on back;
- Frame made out of hardwood.

Wood finishes: Available colors: White Wash WW, Golden Wheat GW, Sand SD, Apricot AT, Pecan PN, Brandy BR, Chestnut CT, Coffee CF, Espresso ES, Bordeaux BO, Black Wash BW and Bark BK.

Number of yards for COM fabric:

Code	Total	Backrest	Seat
803	2	2	2

Options

Double Stitching

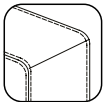

\$0

Prices

Code	GRA	GR1	COM GR2	GR3	GR4	GR5	GR6	GR7	GR8	GR9	GR10	GR11	GR12	Cuir Leather
803	1045	1078	1122	1166	1221	1276	1331	1386	1441	1496	1551	1661	1771	1679

How to Order

		PQD PQS (std)		Combination of Colors			
				Finishes <i>See the Logiflex Color Guide</i>		Fabric <i>See the Logiflex Graded-in List</i>	
SS	803						
series	code	top stitch	base	supplier	pattern	color	
Example	SS	803	PQS	BO	ENNIS	LOFT	AQUA

Chairs

Sedia - Chairs

804

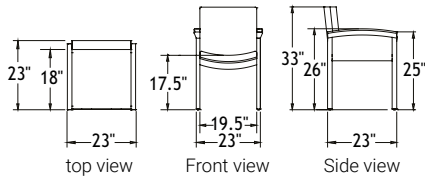
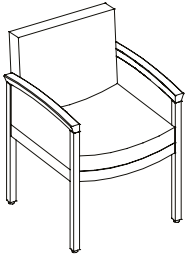

Combination of Colors

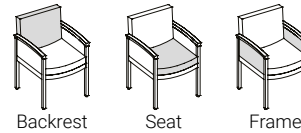

Discontinued Product

Manufacturing Standards

- Single top stitching;
- Elastic straps on seat and back;
- Medium-density foam on seat;
- Low density foam on back;
- Frame made out of hardwood.

Wood finishes: Available colors: White Wash WW, Golden Wheat GW, Sand SD, Apricot AT, Pecan PN, Brandy BR, Chestnut CT, Coffee CF, Espresso ES, Bordeaux BO, Black Wash BW and Bark BK.

Number of yards for COM fabric:

Code	Total	Backrest	Seat	Frame
804	2	2	2	,75

Options

Double Stitching



\$0

Prices

Code	GRA	GR1	COM GR2	GR3	GR4	GR5	GR6	GR7	GR8	GR9	GR10	GR11	GR12	Cuir Leather
804	1199	1232	1276	1320	1375	1430	1485	1540	1595	1650	1705	1815	1925	1833

How to Order

		PQD PQS (std)		Combination of Colors			
		Finishes <i>See the Logiflex Color Guide</i>		Fabric <i>See the Logiflex Graded-in List</i>			
SS	804						
series	code	top stitch	base	supplier	pattern	color	
Example	SS	804	PQS	BO	ENNIS	LOFT	AQUA

Chairs

Milan Bold - Armchair with Plywood Back

BAC

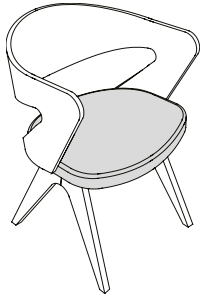

BACC

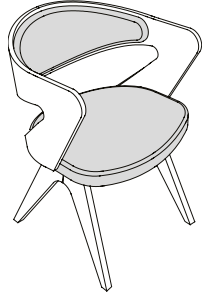

Note: The upholstered back cushion cannot be in vinyl or leather. It is also not recommended to use a pattern fabric on the upholstered back cushion.

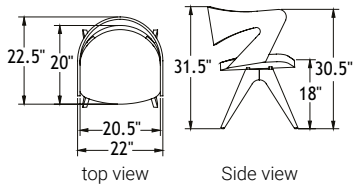

Combination of Colors

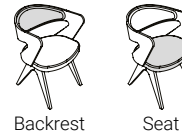

Manufacturing Standards

- Back construction in laminated hardwood veneer;
- Upholstered seat with single top stitching;
- Legs in hardwood;
- **BACC:** cushion added to backrest.

Wood finishes: Available colors: White Wash WW, Golden Wheat GW, Sand SD, Apricot AT, Pecan PN, Brandy BR, Chestnut CT, Coffee CF, Espresso ES, Bordeaux BO, Black Wash BW and Bark BK.

Number of yards for COM fabric:

Code	Total	Backrest	Seat
BAC	.75	-	.75
BACC	1.25	.5	.75

Options

Legs



Prices

Code	GRA	GR1	COM GR2	GR3	GR4	GR5	GR6	GR7	GR8	GR9	GR10	GR11	GR12	Cuir Leather
BAC	1220	1232	1249	1265	1286	1306	1327	1348	1368	1389	1409	1451	1492	1458
BACC	1301	1322	1350	1377	1411	1446	1480	1515	1549	1583	1618	1686	1755	1698

How to Order

			Combination of Colors				
BAC BACC		S B (std)	Finishes <i>See the Logiflex Color Guide</i>		Fabric <i>See the Logiflex Graded-in List</i>		
MN							
series	product	leg	back color	leg color	supplier	pattern	color
Example MN	BAC	B	GW	GW	ENNIS	LOFT	AQUA

Chairs

Milan - Armchair with Plywood Back

AC

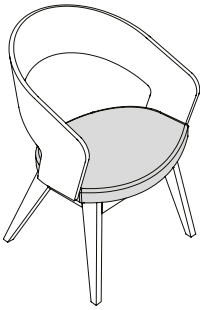

ACC

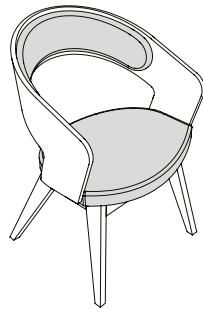

Note: The upholstered back cushion cannot be in vinyl or leather. It is also not recommended to use a pattern fabric on the upholstered back cushion.

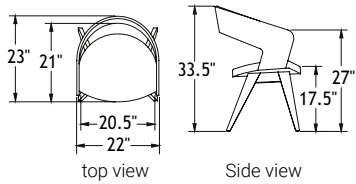

Combination of Colors

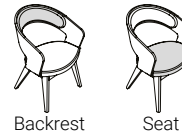

Manufacturing Standards

- Back construction in laminated hardwood veneer;
- Upholstered seat with single top stitching;
- Straight legs in hardwood;
- **ACC:** cushion added to backrest.

Wood finishes: Available colors: White Wash WW, Golden Wheat GW, Sand SD, Apricot AT, Pecan PN, Brandy BR, Chestnut CT, Coffee CF, Espresso ES, Bordeaux BO, Black Wash BW and Bark BK.

Number of yards for COM fabric:

Code	Total	Backrest	Seat
AC	.75	-	.75
ACC	1	.5	.75

Options

Legs



Prices

Code	GRA	GR1	COM GR2	GR3	GR4	GR5	GR6	GR7	GR8	GR9	GR10	GR11	GR12	Cuir Leather
AC	1213	1225	1242	1258	1279	1299	1320	1341	1361	1382	1402	1444	1485	1451
ACC	1300	1317	1339	1361	1389	1416	1444	1471	1499	1526	1554	1609	1664	1618

How to Order

Combination of Colors



Finishes
See the Logiflex Color Guide

Fabric
See the Logiflex Graded-in List

MN	AC ACC	B S (std)	back color	leg color	supplier	pattern	color
series	product	leg					

Example MN AC S GW GW ENNIS LOFT AQUA

Chairs

Milan - Armchair with Upholstered Back

ACU

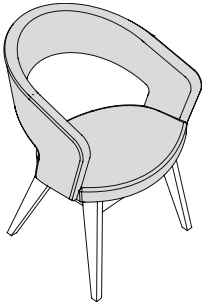

Note: The upholstered back cannot be in vinyl or leather. It is also not recommended to use a pattern fabric on the upholstered back.

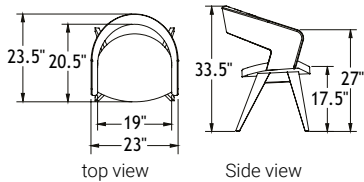

Combination of Colors

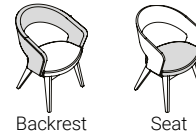

Manufacturing Standards

- Upholstered back with single top stitching;
- Upholstered seat with single top stitching;
- Straight legs in hardwood.

Wood finishes: Available colors: White Wash WW, Golden Wheat GW, Sand SD, Apricot AT, Pecan PN, Brandy BR, Chestnut CT, Coffee CF, Espresso ES, Bordeaux BO, Black Wash BW and Bark BK.

Number of yards for COM fabric:

Code	Total	Backrest	Seat
ACU	2	1.5	.75

Options

Legs

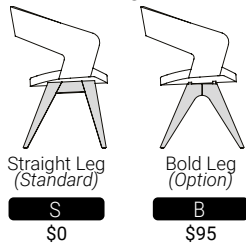

Prices

Code	GRA	GR1	COM GR2	GR3	GR4	GR5	GR6	GR7	GR8	GR9	GR10	GR11	GR12	Cuir Leather
ACU	1222	1255	1299	1343	1398	1453	1508	1563	1618	1673	1728	1838	1948	1856

How to Order

		+		Combination of Colors		
		B S (std)		Finishes <i>See the Logiflex Color Guide</i>		
				Fabric <i>See the Logiflex Graded-in List</i>		
MN	ACU					
series	product	leg	leg color	supplier	pattern	color
Example MN	ACU	S	GW	ENNIS	LOFT	AQUA

Chairs

Milan - Chair with Plywood Back

CH

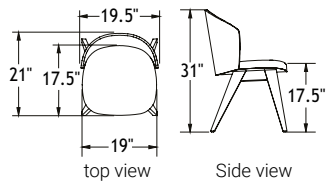
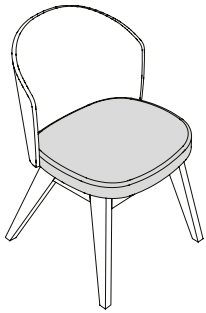

Manufacturing Standards

- Back construction in laminated hardwood veneer;
- Upholstered seat with single top stitching;
- Straight legs in hardwood.

Wood finishes: Available colors: White Wash WW, Golden Wheat GW, Sand SD, Apricot AT, Pecan PN, Brandy BR, Chestnut CT, Coffee CF, Espresso ES, Bordeaux BO, Black Wash BW and Bark BK.

Number of yards for COM fabric:

Code	Total
CH	.75

Options

Legs



Straight Leg
(Standard)

S
\$0



Bold Leg
(Option)

B
\$95

Prices

Code	GRA	GR1	COM GR2	GR3	GR4	GR5	GR6	GR7	GR8	GR9	GR10	GR11	GR12	Cuir Leather
CH	1024	1036	1053	1069	1090	1110	1131	1152	1172	1193	1213	1255	1296	1262

How to Order

		+		Combination of Colors				
MN	CH	B S (std)	Finishes <i>See the Logiflex Color Guide</i>		Fabric <i>See the Logiflex Graded-in List</i>			
series	product	leg	back color	leg color	supplier	pattern	color	
Example MN	CH	S	GW	GW	ENNIS	LOFT	AQUA	

Chairs



Milan - Chair with Upholstered Back

CHU

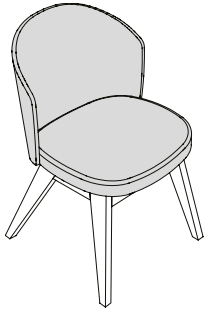

Note: The upholstered back cannot be in vinyl or leather. It is also not recommended to use a pattern fabric on the upholstered back.

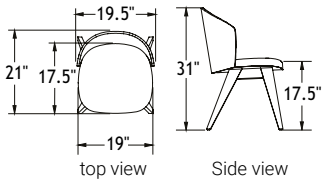

Combination of Colors

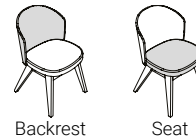

Manufacturing Standards

- Upholstered back with single top stitching;
- Upholstered seat with single top stitching;
- Straight legs in hardwood.

Wood finishes: Available colors: White Wash WW, Golden Wheat GW, Sand SD, Apricot AT, Pecan PN, Brandy BR, Chestnut CT, Coffee CF, Espresso ES, Bordeaux BO, Black Wash BW and Bark BK.

Number of yards for COM fabric:

Code	Total	Backrest	Seat
CHU	1.5	1.25	.75

Options

Legs

Straight Leg (Standard)

S

\$0

Bold Leg (Option)

B

\$95

Prices

Code	GRA	GR1	COM GR2	GR3	GR4	GR5	GR6	GR7	GR8	GR9	GR10	GR11	GR12	Cuir Leather
CHU	1089	1114	1147	1180	1221	1263	1304	1345	1386	1428	1469	1551	1634	1565

How to Order

Finishes			Combination of Colors			
See the Logiflex Color Guide			See the Logiflex Graded-in List			
MN	CHU	B S (std)	leg color	supplier	pattern	color
Example MN	CHU	S	GW	ENNIS	LOFT	AQUA

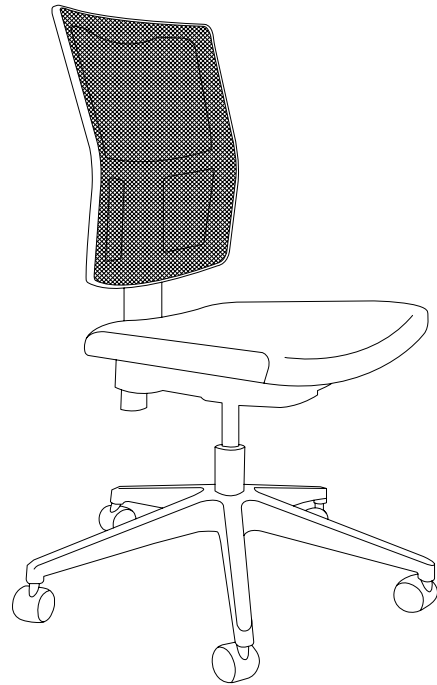

Cyrus Task Seating

This chair is designed with sleek lines, so it fits well in any setting. With a medium fabric mesh backrest, the Cyrus is your go-anywhere chair.

Appendix - CYRUS - Options

Chair bases



VN Black nylon tapered base



ZN Black nylon rounded base



VC Aluminium tapered base
\$160



ZC Aluminium rounded base
\$160



01 Sled base

Mecanism

Mecanism 41
\$55

Options

S Seat sliding option
\$83

Arms



NA
• No arms



F7 Fixed aluminium arms
\$281



F61 Fixed T shaped arms
\$138



FD Closed fixed arms
\$138



FG Open fixed arms
\$138



AD Adjustable arms
\$138



AS Adjustable arms
\$138



AZ Adjustable arms with multi-axis
and pivot armrests
\$281



FZ Fixed arms
\$281

Legs



H Casters for carpeting



S Casters for hard surfaces



G Nylon glides

Task Seating

Cyrus - Chair - Medium back

CYRUS

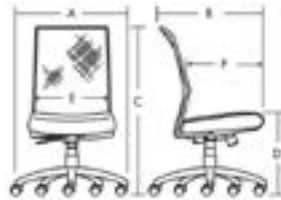
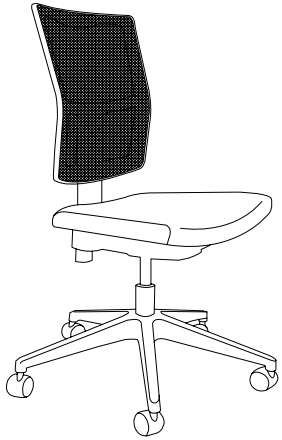

A Chair width	26"
B Chair depth	24"
C Chair height	39,5" - 44,5"
D Seat height	17" - 22"
E Backrest width	19,5"
F Seat depth	18,5"

Manufacturing Standards

Cyrus chair

- Medium back in black mesh fabric hugging the curve of the back;
- Seat with polyurethane foam;
- Choice of adjustable or fixed armrests;
- Choice of black nylon or aluminum base with casters;
- Weight of 40 lbs and volume of 10ft³;

Fabric finishes: Selection of fabrics or vinyl by the customer from the supplier of their choice.

Number of yards for COM fabric:

Code	Total
CYRUS	0,8

Options

Chair options



See [Appendix F](#) for complete options

Prices

Code	GRA	GR1	COM	GR2	GR3	GR4	GR5	GR6	GR7	GR8	GR9	GR10	GR11	GR12	Cuir Leather
CY	809	833	858	882	911	941	970	1001	1032	1060	1091	1152	1212	1071	

Bases

ZN - VN
\$0

ZC - VC
\$160

Mecanism

41
\$55

Option

S
\$83

Arms

NA
\$0

AS - AD - FG - FD - F61
\$138

AZ - FZ - F7
\$281

Legs

H - S - G
\$0

How to Order

											Combination of Colors						
											Fabrics <i>See the fabric chart Logiflex grade</i>						
LC-	CY	-	MWE	-	ZN	41	S	NA, AS, AD, F61, FG, FD, AZ, F7, FZ	H	S	G	ENNIS	LOFT	AQUA	-	MB06	
serie	Structure		base	mechanism	Option	arm	leg	supplier	pattern	color	Mesh fabric						
Example	LC-	CY	-	MWE	-	ZN	41	S	-	NA	-	H	ENNIS	LOFT	AQUA	-	MB06

Task Seating

Cyrus - Visitor chair with sled base - Medium back

CYRUS

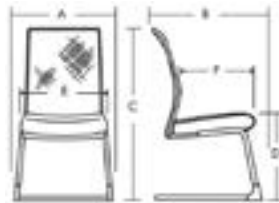
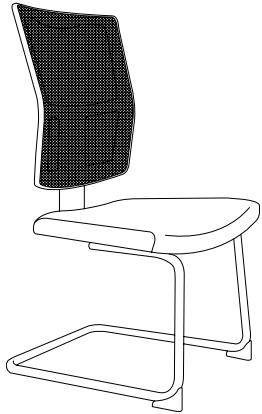

A Chair width	23"
B Chair depth	24"
C Chair height	40,5"
D Seat height	18"
E Backrest width	19,5"
F Seat depth	18,5"

Manufacturing Standards

Cyrus chair

- Medium back in black mesh fabric hugging the curve of the back;
- Seat with polyurethane foam;
- Choice of adjustable or fixed armrests;
- Choice of black nylon or aluminum base with casters;
- Weight of 40 lbs and volume of 10ft³;

Fabric finishes: Selection of fabrics or vinyl by the customer from the supplier of their choice.

Number of yards for COM fabric:

Code	Total
CYRUS	0,8

Options

Chair options



See [Appendix F](#) for complete options

Prices

Code	GRA	GR1	COM GR2	GR3	GR4	GR5	GR6	GR7	GR8	GR9	GR10	GR11	GR12	Cuir Leather
CY	783	807	832	855	886	915	946	976	1007	1035	1067	1125	1186	1046

Arms

NA

\$0

AS - AD - FG - FD - F61

\$138

AZ - FZ - F7

\$281

How to Order

Combination of Colors

NA, AS, AD,
F61, FG, FD,
AZ, F7, FZ

Fabrics
[See the fabric chart](#)
[Logiflex grade](#)

LC-	CY	-	MWE	-	01	-		-	N				-	MB06
serie	Structure	sled base	arm	leg	supplier	pattern	color	Mesh fabric						

Example

LC-	CY	-	MWE	-	01	-	NA	-	N	ENNIS	LOFT	AQUA	-	MB06
-----	----	---	-----	---	----	---	----	---	---	-------	------	------	---	------

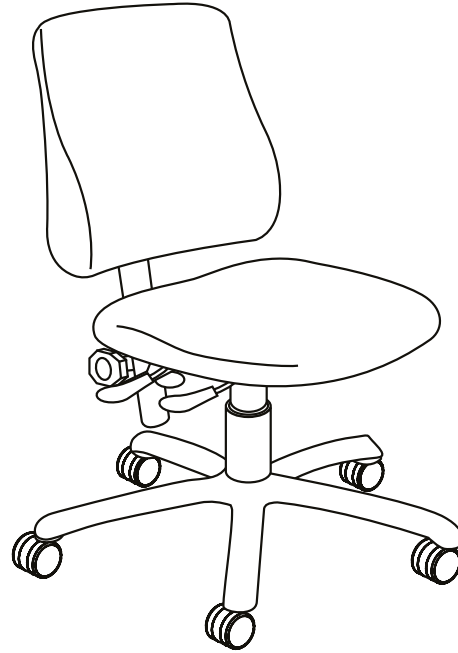
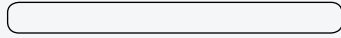

Texto Task Seating

The Texto is Logiflex's most customizable chair, with a variety of different options. Plus, it's ergonomically adjustable with multiple configurations to provide lasting comfort.

Appendix - TEXTO - Options

Chair Width



1 **Narrow seat** (-2")



2 **Standard seat**



3 **Large seat** (+2")
\$160

Chair Back



L **Low back**



M **Medium back**



D **Director back**



H **High back with headrest**

Chair Base



VN **Black nylon tapered base**



ZN **Black nylon rounded base**



VC **Aluminium tapered base**
\$160



ZC **Aluminium rounded base**
\$160



01 **Sled base**



TN **Aluminium rounded stool base**



TC **Aluminium rounded stool base**
\$160

Mechanisms

Mechanism 10 - 11 - 20 - 21

Mechanism 31
\$28

Mechanism 41 - 51
\$55

Mechanism 71
\$116

Mechanism 76F (only with option F)
\$163

Options

S **Seat sliding option**
\$83

R **Back height adjustment option**
\$33

F **Combined options**
\$116



Appendix - TEXTO - Options

Arms



NA
• No arm



AD Adjustable arms
\$138



AS Adjustable arms
\$138



FD Closed fixed arms
\$138



FG Open fixed arms
\$138



FT Open curved fixed arms
\$138



AZ Adjustable arms with multi-axis
and pivot armrests
\$281



FZ Fixed arms
\$281



AG Adjustable arms
\$138



AP Adjustable arms
\$138



AR Adjustable arms
\$138



AW Adjustable arms with pivot
\$138



AX Adjustable arms with multi-axis
armrests
\$220



AY Adjustable arms with multi-axis
and pivot armrests
\$220

Legs



H Casters for carpeting



S Casters for hand surfaces



G Nylon glides



M Mixed (3 casters, 2 glides)

Task Seating

Texto - Chair - Low back

TEXTO

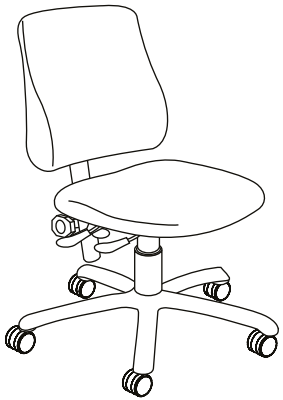

A Chair width	26"
B Chair depth	24"
C Chair height	34" - 39"
D Seat height	17" - 22"
E Backrest width	19"
F Seat depth	18"

Manufacturing Standards

Texto chair:

- Low back following the curve of the back;
- Upholstered seat;
- Choice of black nylon or aluminum base with casters;
- Choice of mechanism;
- Choice of adjustable or fixed arms;
- 40 lbs weight and 10ft³ volume.

Mechanism 76F: Only with option F.

Options: Back height adjustment (R), seat sliding (S).

Fabric finishes: Selection of fabrics or vinyl by the customer from the supplier of their choice.

Number of yards for COM fabric:

Code	Total
TEXTO	1,3

Options

Chair options



See [Appendix F](#) for complete options

Prices

Code	GRA	GR1	COM	GR2	GR3	GR4	GR5	GR6	GR7	GR8	GR9	GR10	GR11	GR12	Cuir Leather
TX	811	842	873	904	944	980	1021	1062	1100	1137	1177	1254	1333	1375	

Width		Back	Base		Mechanism				Arms		Legs
1 - 2 \$0	3 \$160	L 0\$	ZN - VN \$0	ZC - VC \$160	10 - 11 - 20 - 21 0\$	31 \$28	41 - 51 \$55	71 \$116	76F \$163		
Options					NA \$0		AS - AD - AW - AG - AR - AP - FT - FG - FD \$138		AX - AY \$220		AZ - FZ \$281
R \$33	S \$83	F \$116							H - S - G \$0		

How to Order

										Combination of Colors							
										Fabrics							
										See the fabric chart Logiflex grade							
LC-	TX	-	L	WW	-												
serie	Width		Back	Structure		Base	Mechanism	Option		Arms		Legs	supplier				
Example	LC-	TX	1	-	L	WW	-	ZN	10	R	-	NA	-	H	ENNIS	LOFT	AQUA

Task Seating

Texto - Chair - Medium back

TEXTO

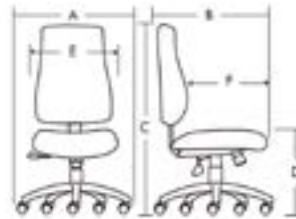
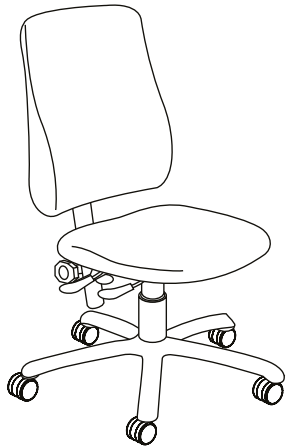

A Chair width	26"
B Chair depth	24"
C Chair height	38" - 43"
D Seat height	17" - 22"
E Backrest width	19"
F Seat depth	18"

Manufacturing Standards

Texto chair:

- Medium back following the curve of the back;
- Upholstered seat;
- Choice of black nylon or aluminum base with casters;
- Choice of mechanism;
- Choice of adjustable or fixed arms;
- 40 lbs weight and 10ft³ volume.

Mechanism 76F: Only with option F.

Options: Back height adjustment (R), seat sliding (S).

Fabric finishes: Selection of fabrics or vinyl by the customer from the supplier of their choice.

Number of yards for COM fabric:

Code	Total
TEXTO	1,5

Options

Chair options



See [Appendix F](#) for complete options

Prices

Code	GRA	GR1	COM	GR2	GR3	GR4	GR5	GR6	GR7	GR8	GR9	GR10	GR11	GR12	Cuir Leather
TX	837	877	913	949	993	1040	1086	1132	1179	1224	1271	1363	1454	1449	

Width		Back	Base		Mechanism				Arms		Legs
1 - 2	3	M	ZN - VN	ZC - VC	10 - 11 - 20 - 21	31	41 - 51	71	76F		
\$0	\$160	0\$	\$0	\$160	0\$	\$28	\$55	\$116	\$163		
Options			Arms				Legs				
R	S	F	NA	AS - AD - AW - AG - AR - AP - FT - FG - FD				AX - AY	AZ - FZ	H - S - G	
\$33	\$83	\$116	\$0	\$138				\$220	\$281	\$0	

How to Order

LC-	TX	-	M	WW	-											
serie	Width		Back	Structure		Base	Mechanism	Option		Arms		Legs	supplier	pattern	color	
1						ZN	10, 11	F		NA, AS, AD, AW, AG, AR, AP, FT, FG, FS, FD, AX, AY, AZ, FZ		H				
2						VN	20, 21	R				S				
3						ZC	31, 41, 45	S				G				
						VC	71, 76F									

Example

LC-	TX	1	-	M	WW	-	ZN	10	R	-	NA	-	H	ENNIS	LOFT	AQUA
-----	----	---	---	---	----	---	----	----	---	---	----	---	---	-------	------	------

Task Seating

Texto - Chair - Director back

TEXTO

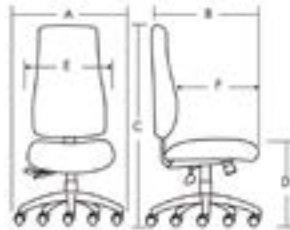
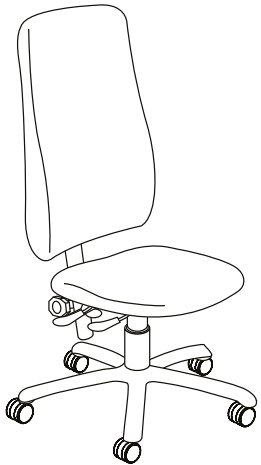

A Chair width	26"
B Chair depth	24"
C Chair height	42" - 47"
D Seat height	17" - 22"
E Backrest width	19"
F Seat depth	18"

Manufacturing Standards

Texto chair:

- Director back following the curve of the back;
- Upholstered seat;
- Choice of black nylon or aluminum base with casters;
- Choice of mechanism;
- Choice of adjustable or fixed arms;
- 45 lbs weight and 13,5ft³ volume.

Mechanism 76F: Only with option F.

Options: Back height adjustment (R), seat sliding (S).

Fabric finishes: Selection of fabrics or vinyl by the customer from the supplier of their choice.

Number of yards for COM fabric:

Code	Total
TEXTO	1,7

Options

Chair options



See [Appendix F](#) for complete options

Prices

Code	GRA	GR1	COM GR2	GR3	GR4	GR5	GR6	GR7	GR8	GR9	GR10	GR11	GR12	Cuir Leather
TX	915	957	1001	1045	1100	1154	1209	1266	1319	1376	1429	1539	1648	1603

Width		Back	Base		Mechanism				Arms		Legs	
1 - 2 \$0	3 \$160	D 0\$	ZN - VN \$0	ZC - VC \$160	10 - 11 - 20 - 21 0\$				31 \$28	41 - 51 \$55	71 \$116	76F \$163
Options		NA \$0		AS - AD - AW - AG - AR - AP - FT - FG - FD \$138				AX - AY \$220	AZ - FZ \$281	H - S - G \$0		
R \$33	S \$83	F \$116										

How to Order

LC-	TX	-	D	WW	-																		
serie	Width	Back	Structure	Base	Mechanism	Option	Arms	Legs	supplier	pattern	color	Combination of Colors											
Example	LC-	TX	1	-	D	WW	-	ZN	10	R	-	NA	-	H	ENNIS	LOFT	AQUA	Fabrics See the fabric chart Logiflex grade					

Task Seating

Texto - Chair - High back with headrest

TEXTO

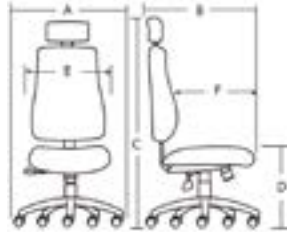
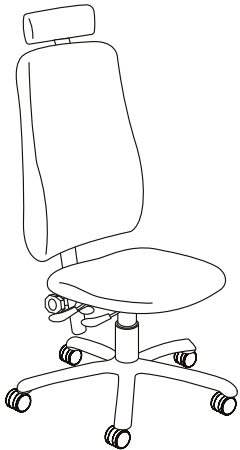

A Chair width	26"
B Chair depth	24"
C Chair height	49" - 54"
D Seat height	17" - 22"
E Backrest width	19"
F Seat depth	18"

Manufacturing Standards

Texto chair:

- High back with headrest following the curve of the back;
- Upholstered seat;
- Choice of black nylon or aluminum base with casters;
- Choice of mechanism;
- Choice of adjustable or fixed arms;
- 50 lbs weight and 13,5ft³ volume.

Mechanism 76F: Only with option F.

Options: Back height adjustment (R), seat sliding (S).

Fabric finishes: Selection of fabrics or vinyl by the customer from the supplier of their choice.

Number of yards for COM fabric:

Code	Total
TEXTO	1,7

Options

Chair options



See [Appendix F](#) for complete options

Prices

Code	GRA	GR1	COM GR2	GR3	GR4	GR5	GR6	GR7	GR8	GR9	GR10	GR11	GR12	Cuir Leather
TX	1019	1063	1106	1150	1205	1260	1313	1370	1425	1480	1533	1643	1752	1707

Width		Back	Base		Mechanism				Arms		Legs	
1 - 2 \$0	3 \$160	H 0\$	ZN - VN \$0	ZC - VC \$160	10 - 11 - 20 - 21 0\$				31 \$28	41 - 51 \$55	71 \$116	76F \$163
Options			NA \$0		AS - AD - AW - AG - AR - AP - FT - FG - FD \$138				AX - AY \$220	AZ - FZ \$281	H - S - G \$0	
R \$33	S \$83	F \$116										

How to Order

LC-	TX	-	H	WW	-												
serie	Width		Back	Structure		Base	Mechanism	Option		Arms		Legs	supplier	pattern	color		
1						ZN	10, 11	F		NA, AS, AD, AW, AG, AR, AP, FT, FG, FS, FD, AX, AY, AZ, FZ		H					
2						VN	20, 21	R				S					
3						ZC	31, 41, 45	S				G					
						VC	71, 76F										
Example	LC-	TX	1	-	H	WW	-	ZN	10	R	-	NA	-	H	ENNIS	LOFT	AQUA

Task Seating

Texto - Stool - Low back

TEXTO

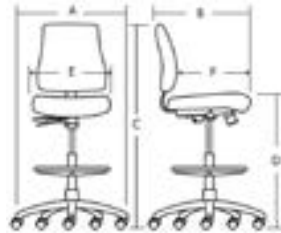
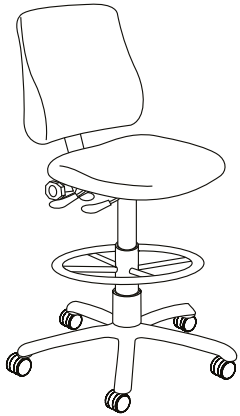

A Chair width	26"
B Chair depth	24"
C Chair height	40" - 50"
D Seat height	23" - 33"
E Backrest width	19"
F Seat depth	18"

Manufacturing Standards

Texto chair (stool):

- Low back following the curve of the back;
- Upholstered seat;
- Choice of black nylon or polished aluminum stool base with casters;
- Choice of mechanism;
- Choice of adjustable or fixed arms;
- 55 lbs weight and 10ft³ volume.

Option: Back height adjustment (R).

Fabric finishes: Selection of fabrics or vinyl by the customer from the supplier of their choice.

Number of yards for COM fabric:

Code	Total
TEXTO	1,3

Options

Chair options



See [Appendix F](#) for complete options

Prices

Code	GRA	GR1	COM GR2	GR3	GR4	GR5	GR6	GR7	GR8	GR9	GR10	GR11	GR12	Cuir Leather
TX	992	1022	1054	1085	1124	1162	1201	1241	1279	1318	1357	1434	1511	1554

Width	Back	Base	Mechanism	Options
1 - 2 \$0	L \$0	TN \$0 TC \$160	11 \$0 31 \$28 51 \$55	R \$33
NA \$0	AS - AD - AW - AG - AR - AP - FT - FG - FD \$138		AX - AY \$220 AZ - FZ \$281	H - S - G - M \$0

How to Order

													Combination of Colors				
													Fabrics <i>See the fabric chart Logiflex grade</i>				
LC-	TX	1 2	-	L	WW	-	TN TC	11, 31, 51	R	-	NA AS, AS, AD, AW, AG, AR, AP, FT, FG, FS, FD, AX, AY, AZ, FZ	-	H S G M	supplier	pattern	color	
Example	LC-	TX	1	-	L	WW	-	TN	11	R	-	NA	-	H	ENNIS	LOFT	AQUA

Task Seating

Texto - Stool - Medium back

TEXTO

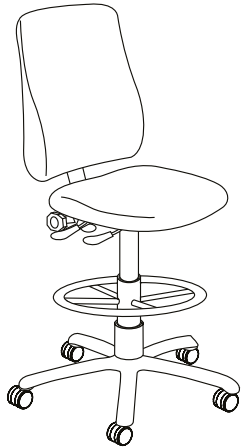

A Chair width	26"
B Chair depth	24"
C Chair height	44" - 54"
D Seat height	23" - 33"
E Backrest width	19"
F Seat depth	18"

Manufacturing Standards

Texto chair (stool):

- Medium back following the curve of the back;
- Upholstered seat;
- Choice of black nylon or polished aluminum stool base with casters;
- Choice of mechanism;
- Choice of adjustable or fixed arms;
- 55 lbs weight and 10ft³ volume.

Option: Back height adjustment (R).

Fabric finishes: Selection of fabrics or vinyl by the customer from the supplier of their choice.

Number of yards for COM fabric:

Code	Total
TEXTO	1,5

Options

Chair options



See [Appendix F](#) for complete options

Prices

Code	GRA	GR1	COM GR2	GR3	GR4	GR5	GR6	GR7	GR8	GR9	GR10	GR11	GR12	Cuir Leather
TX	1018	1056	1092	1129	1175	1222	1267	1313	1360	1404	1451	1543	1635	1629

Width	Back	Base		Mechanism			Options
1 - 2 \$0	M \$0	TN \$0	TC \$160	11 \$0	31 \$28	51 \$55	R \$33
Arms							
NA \$0	AS - AD - AW - AG - AR - AP - FT - FG - FD \$138			AX - AY \$220	AZ - FZ \$281	Legs	
H - S - G - M \$0							

How to Order

													Combination of Colors		
													Fabrics <i>See the fabric chart Logiflex grade</i>		
LC-	TX	1 2	-	M	WW	-	TN TC	11, 31, 51	R	NA, AS, AD, AW, AG, AR, AP, FT, FG, FS, FD, AX, AY, AZ, FZ	H S G M	supplier	pattern	color	
Example	LC-	TX	1	-	M	WW	-	TN	11	R	-	ENNIS	LOFT	AQUA	

Task Seating

Texto - Visitor chair with sled base - Low back

TEXTO

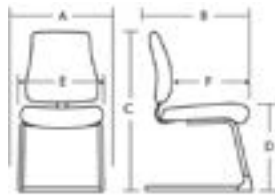
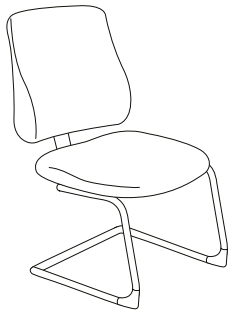

A Chair width	23"
B Chair depth	24"
C Chair height	35"
D Seat height	18"
E Backrest width	19"
F Seat depth	18"

Manufacturing Standards

Texto chair:

- Low back following the curve of the back;
- Upholstered seat;
- Sled base;
- Choice of adjustable or fixed arms;
- 40 lbs weight and 10ft³ volume.

Fabric finishes: Selection of fabrics or vinyl by the customer from the supplier of their choice.

Number of yards for COM fabric:

Code	Total
TEXTO	1,3

Options

Chair options



See [Appendix F](#) for complete options

Prices

Code	GRA	GR1	COM GR2	GR3	GR4	GR5	GR6	GR7	GR8	GR9	GR10	GR11	GR12	Cuir Leather
TX2	771	802	834	865	903	942	979	1021	1060	1098	1136	1214	1293	1469

Back

L
\$0

Arms

NA
\$0

AS - AD - AR - AP - FT - FG - FD
\$138

AZ - FZ
\$281

How to Order

Combination of Colors

NA, AS, AD,
AR, AP, FT,
FG, FD, AZ,
FZ

Fabrics
See the fabric chart
Logiflex grade

LC-	TX2	-	L	WW	-	01	-	-	-	N			
serie	back	Structure	Sled base	Arms	Legs	supplier	pattern	color					

Example LC- TX2 - L WW - 01 - NA - N ENNIS LOFT AQUA

Task Seating

Texto - Visitor chair with sled base - Medium back

TEXTO

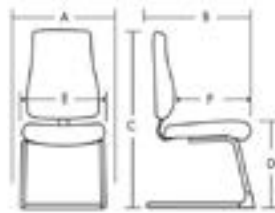
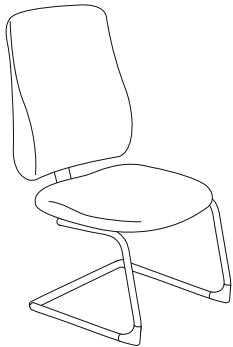

A Chair width	23"
B Chair depth	24"
C Chair height	39"
D Seat height	18"
E Backrest width	19"
F Seat depth	18"

Manufacturing Standards

Texto chair:

- Medium back following the curve of the back;
- Upholstered seat;
- Sled base;
- Choice of adjustable or fixed arms;
- 40 lbs weight and 10ft³ volume.

Fabric finishes: Selection of fabrics or vinyl by the customer from the supplier of their choice.

Number of yards for COM fabric:

Code	Total
TEXTO	1,5

Options

Chair options



See [Appendix F](#) for complete options

Prices

Code	GRA	GR1	COM GR2	GR3	GR4	GR5	GR6	GR7	GR8	GR9	GR10	GR11	GR12	Cuir Leather
TX2	799	835	871	909	955	1001	1047	1092	1137	1184	1230	1322	1425	1542

Back

M
\$0

Arms

NA
\$0

AS - AD - AR - AP - FT - FG - FD
\$138

AZ - FZ
\$281

How to Order

Combination of Colors

NA, AS, AD,
AR, AP, FT,
FG, FD, AZ,
FZ

Fabrics
See the fabric chart
Logiflex grade

LC-	TX2	-	M	WW	-	01	-	-	-	N			
serie	back		Structure	Sled base		Arms		Legs	supplier	pattern	color		

Example

LC-	TX2	-	M	WW	-	01	-	NA	-	N	ENNIS	LOFT	AQUA
-----	-----	---	---	----	---	----	---	----	---	---	-------	------	------

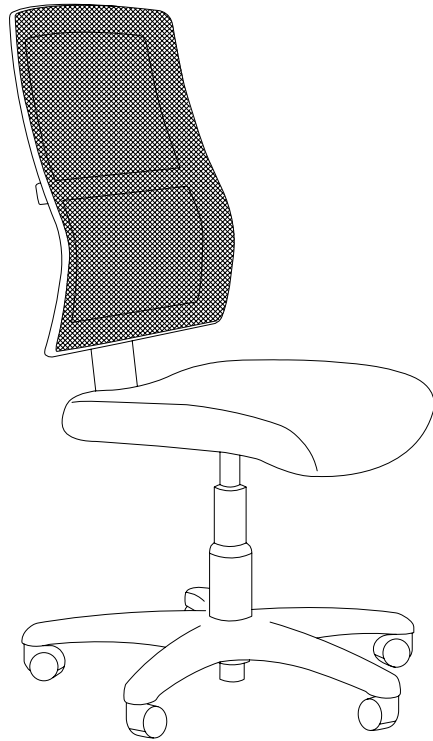

Texto Mesh Task Seating

With fabric mesh backrest and adjustable lumbar support, the Texto Mesh is the perfect office chair.



Appendix - TEXTO MESH - Options

Chair width



2 **Standard seat**



3 **Large seat (+2")**
\$160

Chair base



VN **Black nylon tapered base**



ZN **Black nylon rounded base**



VC **Aluminium tapered base**
\$160



ZC **Aluminium rounded base**
\$160



01 **Sled base**



TN **Aluminium rounded stool base**



TC **Aluminium rounded stool base**
\$160

Mechanisms

Mecanism 10 - 11 - 20 - 21

Mecanism 31
\$28

Mecanism 41 - 51
\$55

Mecanism 71
\$116

Options

S **Seat sliding option**
\$83















R **Back height Adjustment option**
\$33

F **Combined options**
\$116





Task Seating

Appendix - TEXTO MESH - Options

Arms

	NA • No arm		AG Adjustable arms \$138
	AD Adjustable arms \$138		AP Adjustable arms \$138
	AS Adjustable arms \$138		AR Adjustable arms \$138
	FD Closed fixed arms \$138		AW Adjustable arms with pivot \$138
	FG Open fixed arms \$138		AX Adjustable arms with multi-axis armrests \$220
	FT Bras fixes courbés ouverts \$138		AY Adjustable arms with multi-axis and pivot armrests \$220
	AZ Adjustable arms with multi-axis and pivot armrests \$281		
	FZ Fixed arms \$281		

Legs

	H Casters for carpeting
	S Casters for hand surfaces
	G Nylon glides
	M Mixed (3 casters, 2 glides)

Mesh Fabrics

	MA06 Aero Mesh Black PMS Black 6 C (#101820)
	MA16 Graphite PMS Cool Gray 9 C (#75787B)
	MA26 Aluminium PMS #7537 C
	MA60 Sangria PMS #2041 C

Task Seating

Texto Mesh - Chair - Medium Back

TXM2

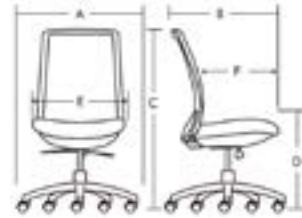
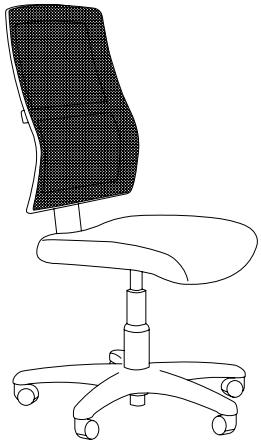

A Chair width	26"
B Chair depth	24"
C Chair height	39" - 44"
D Seat height	17" - 22"
E Backrest width	19"
F Seat depth	18"

Manufacturing Standards

Texto Mesh chair:

- Medium back following the curve of the back;
- Upholstered seat;
- Choice of black nylon or aluminum base with casters;
- Choice of mechanism;
- Choice of adjustable or fixed arms;
- 40 lbs weight and 10ft³ volume.

Options: Back height adjustment (R), seat sliding (S).

Fabric finishes: Selection of fabrics or vinyl by the customer from the supplier of their choice.

Number of yards for COM fabric:

Code	Total
TEXTO	0,9

Options

Chair options



See [Appendix F](#) for complete options

Prices

Code	GRA	GR1	COM	GR2	GR3	GR4	GR5	GR6	GR7	GR8	GR9	GR10	GR11	GR12	Cuir Leather
TXM	835	859	883	908	937	967	997	1026	1058	1087	1117	1178	1239	1098	

Width

2	3
\$0	\$160

Base

ZN - VN	ZC - VC
\$0	\$160

Mechanism

10 - 11 - 20 - 21	31	41 - 51	71
\$0	\$28	\$55	\$116

Options

R	S	F
\$33	\$83	\$116

Arms

NA	AS - AD - AW - AG - AR - AP - FT - FG - FD	AX - AY	AZ - FZ
\$0	\$138	\$220	\$281

Legs

H - S - G
\$0

How to Order

LC-	TXM		-	MWE	-													
serie	width			High + Structure		Base	Mechanism	Option	arms	legs	supplier	pattern	color		Mesh fabric			
Example	LC-	TXM	2	-	MWE	-	ZN	10	R	-	NA	-	H	ENNIS	LOFT	AQUA	-	MA06

Task Seating

Texto Mesh - Stool - Medium back

TXM2

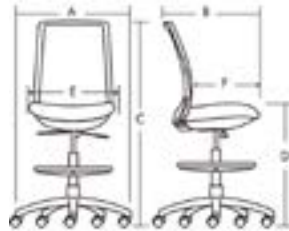
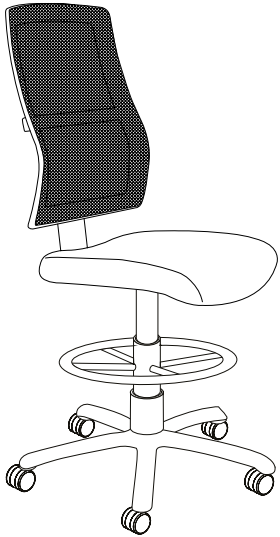

A Chair width	26"
B Chair depth	24"
C Chair height	45" - 55"
D Seat height	23" - 33"
E Backrest width	19"
F Seat depth	18"

Manufacturing Standards

Texto Mesh chair (stool):

- Medium back following the curve of the back;
- Upholstered seat;
- Choice of black nylon or polished aluminum stool base with casters;
- Choice of mechanism;
- Choice of adjustable or fixed arms;
- 55 lbs weight and 10ft³ volume.

Option: Back height adjustment (R).

Fabric finishes: Selection of fabrics or vinyl by the customer from the supplier of their choice.

Number of yards for COM fabric:

Code	Total
TEXTO	0,9

Options

Chair options



See [Appendix F](#) for complete options

Prices

Code	GRA	GR1	COM	GR2	GR3	GR4	GR5	GR6	GR7	GR8	GR9	GR10	GR11	GR12	Cuir Leather
TXM2	1015	1040	1063	1087	1117	1148	1178	1207	1239	1266	1298	1357	1418	1278	

Base

TN	TC
\$0	\$160

Mechanism

11	31	51
\$0	\$28	\$55

Options

R
\$33

Arms

NA	AS - AD - AW - AG - AR - AP - FT - FG - FD	AX - AY	AZ - FZ
\$0	\$138	\$220	\$281

Legs

H - S - G - M
\$0

How to Order

										Combination of Colors							
										Fabrics <i>See the fabric chart Logiflex grade</i>							
LC-	TXM2	-	MWE	-	TN	11, 31, 51	R	NA, AS, AD, AW, AG, AR, AP, FT, FG, FD, AX, AY, AZ, FZ	H S G M	MA06 MA16 MA26 MA60	supplier	pattern	color	Mesh fabric			
serie	High + Structure	Base	Mechanism	Option	arms	legs	supplier	pattern	color	Mesh fabric							
Example	LC-	TXM2	-	MWE	-	TN	11	R	-	NA	-	H	ENNIS	LOFT	AQUA	-	MA06

Task Seating

Texto Mesh - Visitor chair with sled base - Medium back

TXM2

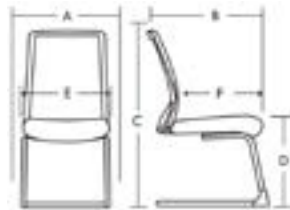
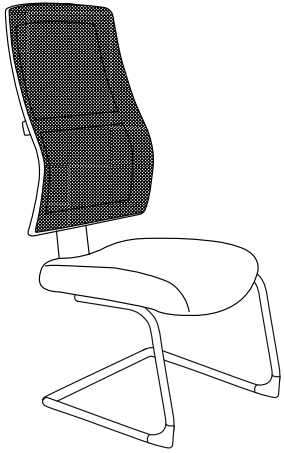

A Chair width	23"
B Chair depth	24"
C Chair height	40"
D Seat height	18"
E Backrest width	19"
F Seat depth	18"

Manufacturing Standards

Texto Mesh chair:

- Medium back following the curve of the back;
- Upholstered seat;
- Sled base;
- Choice of adjustable or fixed arms;
- 40 lbs weight and 10ft³ volume.

Fabric finishes: Selection of fabrics or vinyl by the customer from the supplier of their choice.

Number of yards for COM fabric:

Code	Total
TEXTO	0,9

Options

Chair options



See [Appendix F](#) for complete options

Prices

Code	GRA	GR1	COM	GR2	GR3	GR4	GR5	GR6	GR7	GR8	GR9	GR10	GR11	GR12	Cuir Leather
TXM2	794	818	844	867	898	926	957	988	1018	1046	1079	1136	1198	1058	

Arms

NA
\$0

AS - AD - AR - AP - FT - FG - FD
\$138

AZ - FZ
\$281

How to Order

Combination of Colors

NA, AS, AD,
AR, AP, FT,
FG, FD, AZ,
FZ

Fabrics
See the fabric chart
Logiflex grade

MA06
MA16
MA26
MA60

LC-	TXM2	-	MWE	-	01	-		-	N						
	serie		High + Structure		sled base		arms		legs	supplier	pattern	color		Mesh fabric	

Example LC- TXM2 - MWE - 01 - NA - N ENNIS LOFT AQUA - MA06

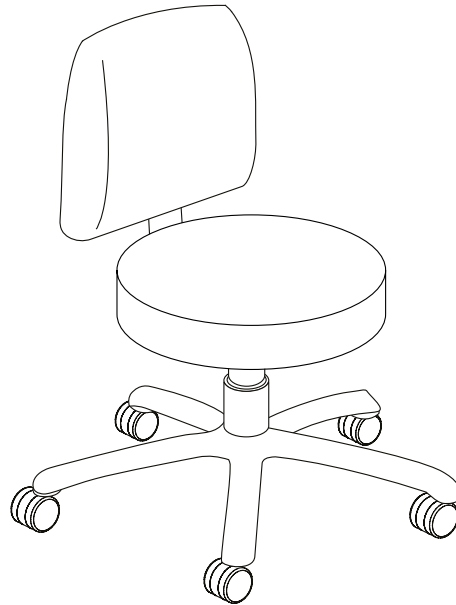

Texto Lab Laboratory Seating

A round seat and different backrest options make the Texto Lab a versatile chair that doesn't take up much space. It can easily be tucked under a counter, and a stool version is available with a footrest.

Appendix - TEXTO LAB - Options

Chair back



X No back



T T-shaped back



C Contour back



L Low back

Chair base



ZN Black nylon rounded base



ZC Aluminium rounded base
\$160



TN Aluminium rounded stool base



TC Aluminium rounded stool base
\$160

Mechanisms

Mecanism 11

Mecanism 31
\$28

Mecanism 51
\$55

Option

R Back height Adjustment option
\$33

Legs



H Casters for carpeting



S Casters for hand surfaces



G Nylon glides



M Mixed (3 casters, 2 glides)

Task Seating

Texto Lab - Chair - No back

TXR

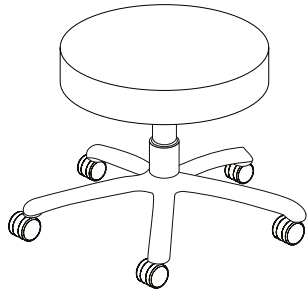

A Chair width	26"
B Chair depth	17,5"
C Chair high (cyl.24)	15,5" - 20,5"
C Chair high (cyl.30)	17" - 24,5"

Manufacturing Standards

- Texto Lab chair:
- No back;
 - Upholstered seat;
 - Choice of black nylon or aluminum base with casters;
 - Choice of cylinder;
 - 20 lbs weight and 6ft³ volume.

Fabric finishes: Selection of fabrics or vinyl by the customer from the supplier of their choice.

Number of yards for COM fabric:

Code	Total
TEXTO	0,7

Options

Chair options



See [Appendix F](#) for complete options

Prices

Code	GRA	GR1	COM GR2	GR3	GR4	GR5	GR6	GR7	GR8	GR9	GR10	GR11	GR12	Cuir Leather
TXR	491	509	528	547	569	593	616	638	661	685	707	754	800	802

Back	Base	Cylinder	Legs
X \$0	ZN \$0 ZC \$160	24 - 30 \$0	H - S - G - M \$0

How to Order

Combination of Colors

LC-	TXR	-	X	WW	-	ZN ZC	18 24	13	-	NA	-	H S G M			
serie	back		Structure	Base	Cylinder	Mechanism	arms	legs	supplier	pattern	color				

Fabrics
 See the fabric chart
 Logiflex grade

Example

LC-	TXR	-	X	WW	-	ZN	18	13	-	NA	-	H	ENNIS	LOFT	AQUA
-----	-----	---	---	----	---	----	----	----	---	----	---	---	-------	------	------

Task Seating

Texto Lab - Chair - T-shaped back

TXR

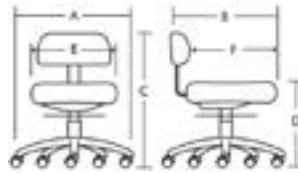
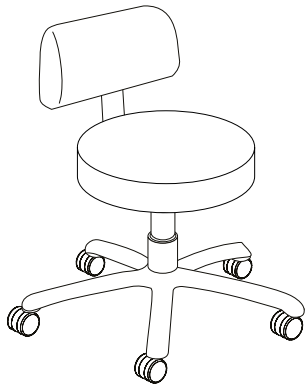

A Chair width	26"
B Chair depth	21"
C Chair high (cyl.24)	25,5" - 30,5"
C Chair high (cyl.30)	27" - 34,5"
D Seat height (cyl.24)	15,5" - 20,5"
D Seat height (cyl.30)	17" - 24,5"
E Back width	17,5"
F Seat depth	17,5"

Manufacturing Standards

- Texto Lab chair:
- T-shaped back;
 - Upholstered seat;
 - Choice of black nylon or aluminum base with casters;
 - Choice of cylinder;
 - 20 lbs weight and 6ft³ volume.

Fabric finishes: Selection of fabrics or vinyl by the customer from the supplier of their choice.

Number of yards for COM fabric:

Code	Total
TEXTO	0,7

Options

Chair options



See [Appendix F](#) for complete options

Prices

Code	GRA	GR1	COM GR2	GR3	GR4	GR5	GR6	GR7	GR8	GR9	GR10	GR11	GR12	Cuir Leather
TXR	584	603	622	639	662	686	708	732	755	778	801	847	893	895

Back	Base	Cylinder	Legs
T \$0	ZN \$0 ZC \$160	24 - 30 \$0	H - S - G - M \$0

How to Order

Combination of Colors

LC-	TXR	-	T	WW	-	ZN	18	13	-	NA	-	H	ENNIS	LOFT	AQUA
	serie		back	Structure		Base	Cylinder	Mechanism		arms		legs	supplier	pattern	color

Example LC- TXR - T WW - ZN 18 13 - NA - H ENNIS LOFT AQUA

Task Seating

Texto Lab - Chair - Contour back

TXR

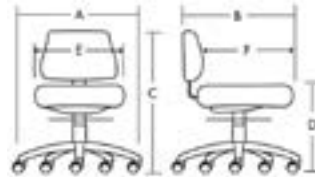
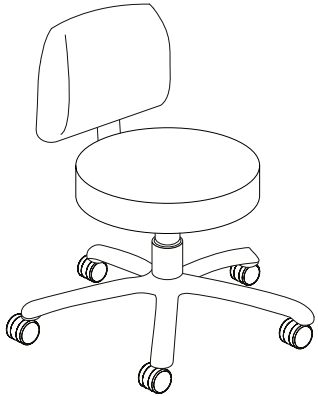

A Chair width	26"
B Chair depth	21"
C Chair high (cyl.24)	26,5" - 31,5"
C Chair high (cyl.30)	28" - 35,5"
D Seat height (cyl.24)	16,5" - 21,5"
D Seat height (cyl.30)	18" - 25,5"
E Back width	17,5"
F Seat depth	17,5"

Manufacturing Standards

Texto Lab chair:

- Contour back;
- Upholstered seat;
- Choice of black nylon or aluminum base with casters;
- Choice of cylinder;
- Choice of mechanism;
- 30 lbs weight and 10ft³ volume.

Option: Back height adjustment (R).

Fabric finishes: Selection of fabrics or vinyl by the customer from the supplier of their choice.

Number of yards for COM fabric:

Code	Total
TEXTO	0,95

Options

Chair options



See [Appendix F](#) for complete options

Prices

Code	GRA	GR1	COM GR2	GR3	GR4	GR5	GR6	GR7	GR8	GR9	GR10	GR11	GR12	Cuir Leather
TXR	684	708	734	759	792	824	855	888	920	950	983	1046	1111	1122

Back	Base	Cylinder	Mechanism	Option	Legs
C	ZN ZC	18 - 24	11 31 51	R	H - S - G - M
\$0	\$0 \$160	\$0	\$0 \$28 \$55	\$33	\$0

How to Order

													Combination of Colors				
													Fabrics <i>See the fabric chart Logiflex grade</i>				
LC-	TXR	-	C	WW	-	ZN ZC	18 24	11, 31, 51	R	-	NA	-	H S G M	supplier	pattern	color	
serie	back	Structure	Base	Cylinder	Mechanism	Option	Arms	Legs	supplier	pattern	color						
Exemple	LC-	TXR	-	C	WW	-	ZN	18	11	R	-	NA	-	H	ENNIS	LOFT	AQUA

Task Seating

Texto Lab - Chair - Low back

TXR

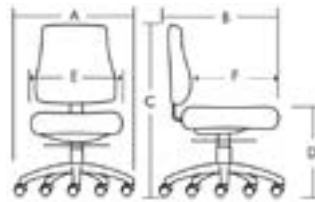
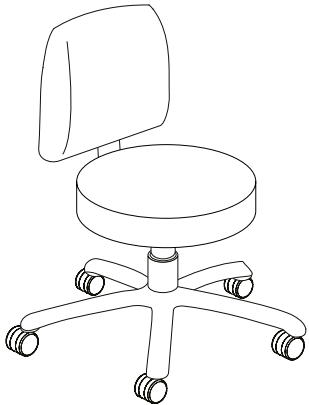

A Chair width	26"
B Chair depth	24"
C Chair high (cyl.24)	33,5" - 38,5"
C Chair high (cyl.30)	35" - 42,5"
D Seat height (cyl.24)	16,5" - 21,5"
D Seat height (cyl.30)	18" - 25,5"
E Back width	17,5"
F Seat depth	17,5"

Manufacturing Standards

Texto Lab chair:

- Low back following the curve of the back;
- Upholstered seat;
- Choice of black nylon or aluminum base with casters;
- Choice of cylinder;
- Choice of mechanism;
- 40 lbs weight and 10ft³ volume.

Option: Back height adjustment (R).

Fabric finishes: Selection of fabrics or vinyl by the customer from the supplier of their choice.

Number of yards for COM fabric:

Code	Total
TEXTO	1,3

Options

Chair options

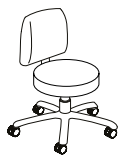

See [Appendix F](#) for complete options

Prices

Code	GRA	GR1	COM GR2	GR3	GR4	GR5	GR6	GR7	GR8	GR9	GR10	GR11	GR12	Cuir Leather
TXR	778	814	849	883	928	972	1018	1062	1106	1150	1194	1284	1371	1411

Back	Base	Cylinder	Mechanism	Option	Legs
L	ZN ZC	18 - 24	11 31 51	R	H - S - G - M
\$0	\$0 \$160	\$0	\$0 \$28 \$55	\$33	\$0

How to Order

													Combination of Colors				
													Fabrics <i>See the fabric chart Logiflex grade</i>				
LC-	TXR	-	L	WW	-	ZN ZC	18 24	11, 31, 51	R	-	NA	-	H S G M				
serie	back		Structure			Base	Cylinder	Mechanism	Option		Arms		Legs	supplier	pattern	color	
Example	LC-	TXR	-	L	WW	-	ZN	18	11	R	-	NA	-	H	ENNIS	LOFT	AQUA

Task Seating

Texto Lab - Stool - No back

TXR

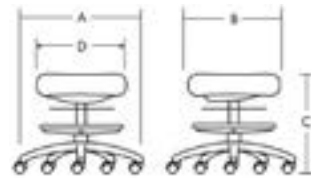
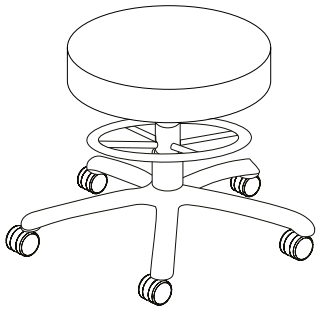

A Chair width	26"
B Chair depth	17,5"
C Chair high (cyl.24)	17" - 24,5"
C Chair high (cyl.30)	22" - 32"
D Back width	17,5"

Manufacturing Standards

Texto Lab chair (stool):

- No back;
- Upholstered seat;
- Choice of black nylon or polished aluminum stool base with casters;
- Choice of cylinder;
- 30 lbs weight and 6ft³ volume.

Fabric finishes: Selection of fabrics or vinyl by the customer from the supplier of their choice.

Number of yards for COM fabric:

Code	Total
TEXTO	0,7

Options

Chair options

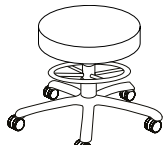

See [Appendix F](#) for complete options

Prices

Code	GRA	GR1	COM GR2	GR3	GR4	GR5	GR6	GR7	GR8	GR9	GR10	GR11	GR12	Cuir Leather
TXR	671	690	707	726	749	772	795	818	840	865	888	932	979	983

Back

X

\$0

Base

TN

\$0

TC

\$160

Cylinder

24 - 30

\$0

Legs

H - S - G - M

\$0

How to Order

Combination of Colors

Fabrics

See the [fabric chart](#)
Logiflex grade

LC-	TXR	-	X	WW	-	TN	24	13	-	NA	-	H	S	G	M	supplier	pattern	color

Example LC- TXR - X WW - TN 24 13 - NA - H ENNIS LOFT AQUA

Task Seating

Texto Lab - Stool - T-shaped back

TXR

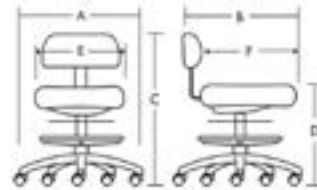
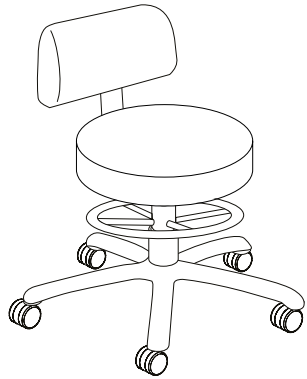

A Chair width	26"
B Chair depth	21"
C Chair high (cyl.24)	27" - 34,5"
C Chair high (cyl.30)	32" - 42"
D Seat height (cyl.24)	17" - 24,5"
D Seat height (cyl.30)	22" - 32"
E Back width	17,5"
F Seat depth	17,5"

Manufacturing Standards

Texto Lab chair (stool):

- T-shaped back;
- Upholstered seat;
- Choice of black nylon or polished aluminum stool base with casters;
- Choice of cylinder;
- 40 lbs weight and 10ft³ volume.

Fabric finishes: Selection of fabrics or vinyl by the customer from the supplier of their choice.

Number of yards for COM fabric:

Code	Total
TEXTO	0,8

Options

Chair options



See [Appendix F](#) for complete options

Prices

Code	GRA	GR1	COM GR2	GR3	GR4	GR5	GR6	GR7	GR8	GR9	GR10	GR11	GR12	Cuir Leather
TXR	765	783	801	821	842	867	890	913	934	959	3247	1025	1071	1075

Back

T

\$0

Base

TN

\$0

TC

\$160

Cylinder

24 - 30

\$0

Legs

H - S - G - M

\$0

How to Order

Combination of Colors

Fabrics

See the [fabric chart](#)
Logiflex grade

LC-	TXR	-	T	WW	-	TN	24	13	-	NA	-	H	S	G	M			
	serie		back	Structure		Base	Cylinder	Mechanism		Arms		Legs	supplier	pattern	color			

Example

LC-	TXR	-	T	WW	-	TN	24	13	-	NA	-	H	ENNIS	LOFT	AQUA
-----	-----	---	---	----	---	----	----	----	---	----	---	---	-------	------	------

Task Seating

Texto Lab - Stool - Contour back

TXR

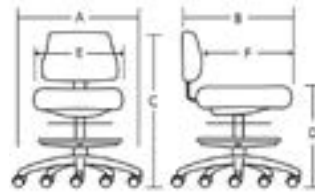
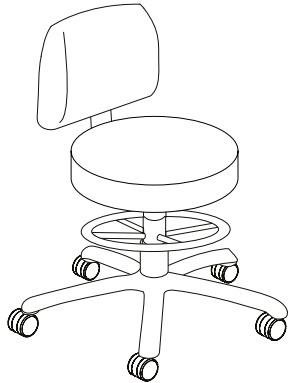

A Chair width	26"
B Chair depth	21"
C Chair high (cyl.24)	27" - 34,5"
C Chair high (cyl.30)	32" - 42"
D Seat height (cyl.24)	17" - 24,5"
D Seat height (cyl.30)	22" - 32"
E Back width	17,5"
F Seat depth	17,5"

Manufacturing Standards

Texto Lab chair (stool):

- Contour back;
- Upholstered seat;
- Choice of black nylon or polished aluminum stool base with casters;
- Choice of cylinder;
- Choice of mechanism;
- 30 lbs weight and 10ft³ volume.

Option: Back height adjustment (R).

Fabric finishes: Selection of fabrics or vinyl by the customer from the supplier of their choice.

Number of yards for COM fabric:

Code	Total
TEXTO	0,95

Options

Chair options

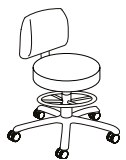

See [Appendix F](#) for complete options

Prices

Code	GRA	GR1	COM GR2	GR3	GR4	GR5	GR6	GR7	GR8	GR9	GR10	GR11	GR12	Cuir Leather
TXR	864	890	915	939	971	1002	1036	1067	1099	1131	1162	1227	1290	1302

Back	Base	Cylinder	Mechanism	Options	Legs
C	TN TC	24 - 30	11 31 51	R	H - S - G - M
\$0	\$0 \$160	\$0	\$0 \$28 \$55	\$33	\$0

How to Order

													Combination of Colors				
													Fabrics <i>See the fabric chart Logiflex grade</i>				
LC-	TXR	-	C	WW	-	TN TC	24 30	11, 31, 51	R	-	NA	-	H S G M	supplier	pattern	color	
serie	back	Structure	Base	Cylinder	Mechanism	Option	Arms	Legs	supplier	pattern	color	supplier	pattern	color	supplier	pattern	color
Example	LC-	TXR	-	C	WW	-	TN	24	11	R	-	NA	-	H	ENNIS	LOFT	AQUA

Task Seating

Texto Lab - Stool - Low back

TXR

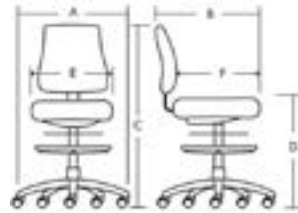
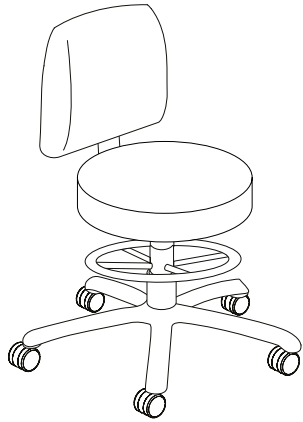

A Chair width	26"
B Chair depth	21"
C Chair high (cyl.24)	27" - 34,5"
C Chair high (cyl.30)	32" - 42"
D Seat height (cyl.24)	17" - 24,5"
D Seat height (cyl.30)	22" - 32"
E Back width	17,5"
F Seat depth	17,5"

Manufacturing Standards

Texto Lab chair (stool):

- Low back following the curve of the back;
- Upholstered seat;
- Choice of black nylon or polished aluminum stool base with casters;
- Choice of cylinder;
- Choice of mechanism;
- 30 lbs weight and 10ft³ volume.

Option: Back height adjustment (R).

Fabric finishes: Selection of fabrics or vinyl by the customer from the supplier of their choice.

Number of yards for COM fabric:

Code	Total
TEXTO	0,95

Options

Chair options

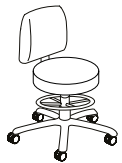

See [Appendix F](#) for complete options

Prices

Code	GRA	GR1	COM GR2	GR3	GR4	GR5	GR6	GR7	GR8	GR9	GR10	GR11	GR12	Cuir Leather
TXR	959	993	1029	1064	1109	1154	1197	1241	1286	1330	1373	1462	1551	1593

Back	Base	Cylinder	Mechanism	Options	Legs
L	TN TC	24 - 30	11 31 51	R	H - S - G - M
\$0	\$0 \$160	\$0	\$0 \$28 \$55	\$33	\$0

How to Order

													Combination of Colors				
													Fabrics <i>See the fabric chart Logiflex grade</i>				
LC-	TXR	-	L	WW	-	TN TC	24 30	11, 31, 51	R	-	NA	-	H S G M				
serie	back		Structure			Base	Cylinder	Mechanism	Option		Arms		Legs	supplier	pattern	color	
Example	LC-	TXR	-	L	WW	-	TN	24	11	R	-	NA	-	H	ENNIS	LOFT	AQUA

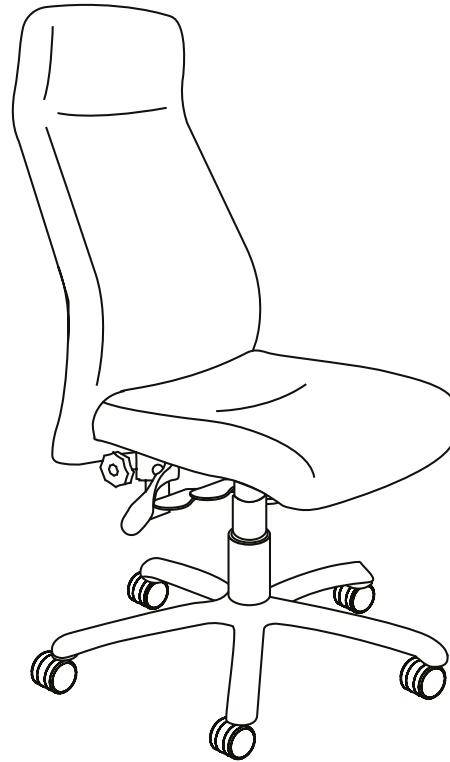

Elie Task Seating

The elegant and prestigious Elie Chair is the perfect choice for executives. The sled base option means that it can also be used for guests, and it fits perfectly with any decor.



Appendix - ELIE - Options

Chair backs



M Medium back



H High back

Chair bases



VN Black nylon tapered base



ZN Black nylon rounded base



VC Aluminium tapered base
\$160



ZC Aluminium rounded base
\$160



01 Sled base

Mechanism

Mechanism 10 - 11 - 20 - 21

Mechanism 31
\$28

Mechanism 41 - 51
\$55

Options

S Seat sliding option
\$83

Arms



NA
• No arms



AD Adjustable arms
\$138



AS Adjustable arms
\$138



FD Closed fixed arms
\$138



FG Open fixed arms
\$138



FT Open curved fixed arms
\$138



AZ Adjustable arms with multi-axis
and pivot armrests
\$281



FZ Fixed arms
\$281

Legs



H Casters for carpeting



S Casters for hard surfaces



G Nylon glides

Task Seating

Elie - Chair - Medium back

ELIE

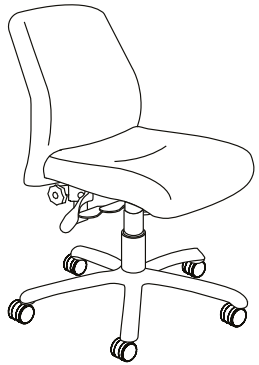

A Chair width	26"
B Chair depth	24,5"
C Chair height	38,5" - 43,5"
D Seat height	17,5" - 22,5"
E Backrest width	19"
F Seat depth	19"

Manufacturing Standards

- Elie chair:
- Medium back following the curve of the back;
 - Upholstered seat;
 - Choice of black nylon or aluminum base with casters;
 - Choice of mechanism;
 - Choice of adjustable or fixed arms;
 - 45 lbs weight and 13,5ft³ volume.

Option: Seat sliding (S).

Fabric finishes: Selection of fabrics or vinyl by the customer from the supplier of their choice.

Number of yards for COM fabric:

Code	Total
ELIE	2.1

Options

Chair options



See [Appendix F](#) for complete options

Prices

Code	GRA	GR1	COM GR2	GR3	GR4	GR5	GR6	GR7	GR8	GR9	GR10	GR11	GR12	Cuir Leather
EE	1093	1125	1169	1213	1267	1322	1376	1431	1485	1540	1595	1704	1812	1770

Back	Bases	Mechanisms	Options
M \$0	ZN - VN \$0 ZC - VC \$160	10 - 11 - 20 - 21 \$0 31 \$28 41 - 51 \$55	S \$83
Arms	Legs		
NA \$0 AS - AD - FT - FG - FD \$138 AZ - FZ \$281	H - S - G \$0		

How to Order

											Combination of Colors					
LC-	EE	-	M	WW	-	ZN VN VC	10, 11, 20, 21, 31, 41, 51	S	NA, AS, AD, FT, FG, FD, AZ, FZ	H S G	Fabrics <i>See the fabric chart Logiflex grade</i>					
série	back	structure	base	Mechanism	option	arm	leg	supplier	pattern	color						
Example	LC-	EE	-	M	WW	-	ZN	11	S	-	NA	-	H	ENNIS	LOFT	AQUA

Task Seating

Elie - Chair - High back

ELIE

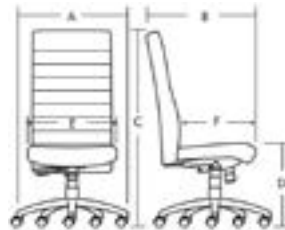
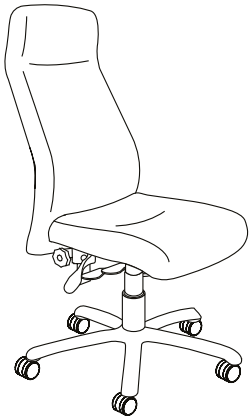

A Chair width	26"
B Chair depth	25"
C Chair height	47,5" - 52,5"
D Seat height	17,5" - 22,5"
E Backrest width	19"
F Seat depth	19"

Manufacturing Standards

Elie chair:

- High back following the curve of the back;
- Upholstered seat;
- Choice of black nylon or aluminum base with casters;
- Choice of mechanism;
- Choice of adjustable or fixed arms;
- 45 lbs weight and 13,5ft³ volume.

Option: Seat sliding (S).

Fabric finishes: Selection of fabrics or vinyl by the customer from the supplier of their choice.

Number of yards for COM fabric:

Code	Total
ELIE	2,3

Options

Chair options



See [Appendix F](#) for complete options

Prices

Code	GRA	GR1	COM GR2	GR3	GR4	GR5	GR6	GR7	GR8	GR9	GR10	GR11	GR12	Cuir Leather
EE	1294	1331	1382	1432	1494	1557	1619	1682	1745	1807	1869	1994	2120	2154

Back

H
\$0

Bases

ZN - VN \$0
ZC - VC \$160

Mechanisms

10 - 11 - 20 - 21 \$0
31 \$28
41 - 51 \$55

Options

S
\$83

Arms

NA \$0
AS - AD - FT - FG - FD \$138

Legs

AZ - FZ \$281
H - S - G \$0

How to Order



Combination of Colors

ZN
VN
VC

10, 11, 20,
21, 31, 41, 51

S

NA, AS, AD,
FT, FG, FD,
AZ, FZ

H
S
G

Fabrics
See the fabric chart
Logiflex grade

LC-	EE	-	H	WW	-									
série	back	structure	base	Mechanism	option	arm	leg	supplier	pattern	color				

Example	LC-	EE	-	H	WW	-	ZN	11	S	-	NA	-	H	ENNIS	LOFT	AQUA
----------------	-----	----	---	---	----	---	----	----	---	---	----	---	---	-------	------	------

Task Seating

Elie - Visitor chair with sled base - Medium back

ELIE

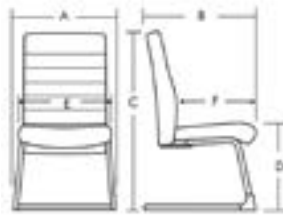
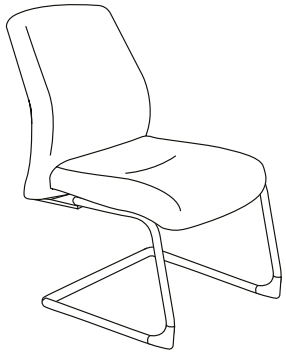

A Chair width	24"
B Chair depth	24,5"
C Chair height	39"
D Seat height	18"
E Backrest width	19"
F Seat depth	19"

Manufacturing Standards

- Elie chair:
- Medium back following the curve of the back;
 - Upholstered seat;
 - Sled base;
 - Choice of adjustable or fixed arms;
 - 45 lbs weight and 13,5ft³ volume.

Fabric finishes: Selection of fabrics or vinyl by the customer from the supplier of their choice.

Number of yards for COM fabric:

Code	Total
ELIE	2,1

Options

Chair options



See [Appendix F](#) for complete options

Prices

Code	GRA	GR1	COM GR2	GR3	GR4	GR5	GR6	GR7	GR8	GR9	GR10	GR11	GR12	Cuir Leather
EE	1055	1087	1131	1175	1229	1284	1338	1393	1447	1502	1557	1665	1773	1731

Arms

NA	AS - AD - FT - FG - FD	AZ - FZ
\$0	\$138	\$281

How to Order

Combination of Colors

NA, AS, AD, FT, FG, FD, AZ, FZ

Fabrics
See the fabric chart
Logiflex grade

LC-	EE	-	MWW	-	01	-	N			
serie	height + structure	sled base	arms	legs	supplier	pattern	color			

Example

LC-	EE	-	MWW	-	01	-	NA	-	N	ENNIS	LOFT	AQUA
-----	----	---	-----	---	----	---	----	---	---	-------	------	------

Accessories

SIT - Electrical Accessories

QIBL

Wireless Charger

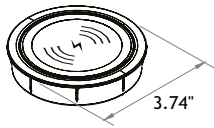

- Air charger wireless;
- Qi compatible device;
- 72" power cable with electric plug;
- Finish: Black.



Code	\$	Description
QIBL	624	

MH3C

Connectivity unit

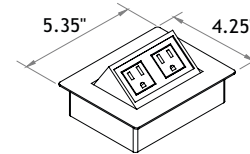

- Retractable connectivity unit with 2 electrical outlets;
- 72" or 120" power cable with electric plug;
- Finish: Satin Nickel.



Code	\$	Description
MH3C	401	Satin Nickel, 72" power cable
MH3C120	415	Satin Nickel, 120" power cable

QIRE

Qi Adapter

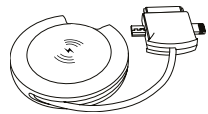

- Receiver to adapt devices not Qi compatible.
- Built-in connections for Apple 30 pin and lightning, Micro-USB.

Code	\$	Description
QIRE	171	

MH3D

Connectivity unit

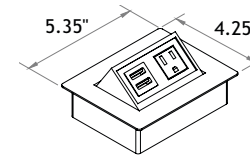

- Retractable connectivity unit with 1 electrical outlet and 2 USB (chargers);
- 72" or 120" power cable with electric plug;
- Finish: Satin Nickel.



Code	\$	Description
MH3DSN	401	Satin Nickel, 72" power cable
MH3DSN120	415	Satin Nickel, 120" power cable
MH3DBL	401	Black, 72" power cable
MH3DBL120	415	Black, 120" power cable
MH3DWH	401	White, 72" power cable
MH3DWH120	415	White, 120" power cable

QIIP

Transmitter for iPhone

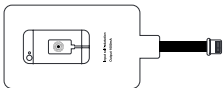

- Receiver for phones without Qi technology;
- For wireless charge devices;
- Adapter for Apple lightning port.

Code	\$	Description
QIIP	112	

As our product line is constantly evolving and expanding, we recommend that you visit logiflex.ca for updates.

logiflex

1235 St-Roch N., Sherbrooke QC J1N 0H2 Canada
T : 1.877.864.9323 | F : 1.800.474.7830 | logiflex.ca

May 22, 2023 | USA

LOGIFLEX | SEATING

