

SEATING

Price List
CANADA 2023



logiflex

Table of Contents

Introduction	3	Modular Seating	23	Chairs	91
Update Summary	4	SIT - Bench	24	Madrid	92
Product Map	5	SIT - Corner Bench	26	STACK6	99
Our social responsibility	8	SIT - Occasional Tables	27	Cart	100
Conditions of Sale	8	Infiniti	36	Sedia - Chairs	101
How to Use the Price List	9	Clara	51	Milan Bold	103
Appendix A: Colors and Finishes	10	Leo	55	Milan	104
Appendix B: Upholstery Specification	12				
Appendix C : SIT	14	Soft Seating	61	Task Chairs	108
Appendix D : Kick plate Colors	15	Alpha	62	Cyrus	109
Appendix E : Wood Color Selection	15	Bulexi	65	Texto	113
Appendix F : Backs/Seats Options for Chairs	16	Dean	68	Texto Mesh	124
Appendix G : Base Options for Chairs	17	Flint	71	Texto Lab	130
Appendix H : Mechanism Options for Chairs	18	Magog	74	Elie	140
Appendix I : Chairs Options	19	Orford	75		
Appendix J : Arms Options for Chairs	20	Stelli	76	Accessories	145
Appendix K : Legs Chairs Options	22	Taylor	80	SIT - Electrical Accessories	146
		Slim	83		

Update Summary

The Seating price list presents these principal modifications:

DATE	SECTION	MODIFICATIONS
February 1, 2023	All the Price List	<ul style="list-style-type: none"> All prices have been increased by approximately 5%. Removal of Alpha, Amigo, Axis and Suavo chairs. Addition of Elie, Texto, Texto Lab and Texto Mesh chairs. Addition of cart XO-10. Modification of Madrid, Stack6 and Cyrus chairs. New certification Indoor Advantage Gold (replace Greenguard).

Previous updates:

DATE	SECTION	MODIFICATIONS
July 1, 2022	All the Price List	<ul style="list-style-type: none"> All prices have been increased by approximately 5%.
	Appendix A	<ul style="list-style-type: none"> Color availability chart update for the HPL.
February 1, 2022	All the Price List	<ul style="list-style-type: none"> All prices have been increased by approximately 6%.
	Chairs	<ul style="list-style-type: none"> Price adjustment for the Cyrus chair 500EA5AB & 500EA5SB. Addition of the black metal for Madrid chair.
	Modular Seating	<ul style="list-style-type: none"> Modification of the dimensions for Infiniti BA26, BADI26 & BADE26
	Conditions of Sales	<ul style="list-style-type: none"> The order modification / cancellation deadline is changed to 48 hours.
October 1, 2021	Appendix A	<ul style="list-style-type: none"> Color availability chart update.
July 1, 2021	All the Price List	<ul style="list-style-type: none"> All prices have been increased by approximately 6%.
May 27, 2021	Chairs	<ul style="list-style-type: none"> Addition of the Stackable Chair STACK6.

Introduction



Product Map

Modular Seating

SIT - Bench	p. 24
-------------	-------

SIT - Occasional Tables	p. 27
-------------------------	-------

Fillers	p. 35
---------	-------

Electrical Accessories	p. 146
------------------------	--------

Infiniti	p. 36
----------	-------

Clara	p. 51
-------	-------

Leo	p. 55
-----	-------

Introduction



Product Map

Armchairs

Alpha p. 62

Bulexi p. 65

Dean p. 68

Flint p. 71

Magog p. 74

Orford p. 75

Stelli p. 76

Taylor p. 80

Slim p. 83

Introduction

Product Map

Chairs

Madrid p. 92



STACK6 p. 99

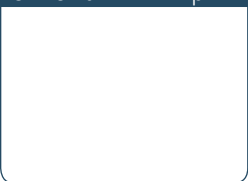

Cart p. 100



Sedia p. 101

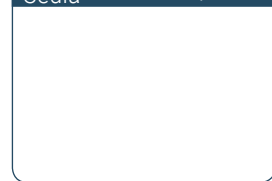

Milan Bold p. 103

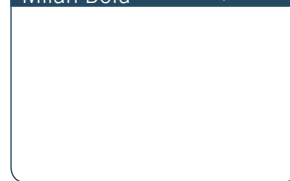

Milan p. 104



Task Chairs

Cyrus p. 109



Texto p. 113



Texto Mesh p. 124



Texto Lab p. 130



Elie p. 140





Our social responsibility

At Logiflex, we have chosen to be a responsible North American manufacturer by implementing initiatives for sustainable development. As much as possible, we source local materials and partner with suppliers who prioritize clean manufacturing processes. We also consolidate goods during transport to reduce our fuel consumption and we continually make changes that help reduce our waste production.

The company is ISO 9001 certified.

You can consult our eco-responsible approach as well as all our certifications in the [Certifications](#) section of our website. Find out how our products can help you obtain LEED credits and the Logiflex products that are Indoor Advantage Gold certified.

Conditions of Sale

Prices

The amounts listed in this document are suggested retail prices and may be changed without notice. Applicable taxes are not included. If you have an open and active account with Logiflex, merchandise will be invoiced at the prices prevailing at the time of shipment. A deposit may be requested if the opening of your account has not been completed or if your account has become inactive.

Terms of Payment

Net 30 days F.O.B. Sherbrooke, Quebec. The invoice will be assigned the shipping date and is payable 30 days from that date. Logiflex remains the owner of the merchandise until the invoice is paid in full.

Customized Products (Special Items)

Price requests for customized products or special items can be submitted via the ["Private Space"](#) section of our website, at www.logiflex.ca. Our quotations department will study your request and send you a quotation and a technical drawing for approval as soon as possible. Modifications to quotations or technical drawings can be requested the same way. The approved quotation(s) and technical drawing(s) can then be attached to your purchase order.

Orders

An official purchase order must be issued for all purchases. Your

purchase order must contain the following information:

- Your company letterhead
- Your reference number
- The delivery address (with contact name, email and phone number)
- The complete product codes
- Furniture colour(s)
- Quantities
- Descriptions
- Retail prices and net prices
- Project registration number (if applicable), and your approved quotation and technical drawing (for special items).

Please note that a quotation cannot serve as a purchase order.

Returns

All returns must first be approved by Logiflex. If the return is accepted, a Logiflex customer service representative will send you an official return authorization form in order to facilitate procedures between you, the carrier, and the Logiflex merchandise reception clerk. Additional costs for shipping or other expenses may be applied following any merchandise returns.

Modifications and/or Cancellations

You have 48 hours from the time we acknowledge receipt of your order to make any requests for corrections or modifications. You may cancel your order during this same 48-hour period. If you would like to modify or cancel your order after this 48-hour verification period, please check with a Logiflex customer service representative. Orders cannot be changed or cancelled if production has already begun or if Logiflex has already received the raw materials.

Liability

Logiflex's liability ends once the carrier has delivered all items in good condition. A delivery receipt signed by the customer acknowledges that the shipment is complete and has been received in good condition.

Claims

Logiflex recommends inspecting the shipment before signing the carrier's delivery receipt. You must notify Logiflex of any incomplete shipments or damaged furniture within 30 days after delivery. Requests to replace damaged products can be made via the ["Private Space"](#) section of our website, at www.logiflex.ca. Our after-sales service department will examine your request and help you correct the situation.

Changes

Logiflex reserves the right to make changes to the materials, accessories, components, specifications and designs, and to discontinue collections and/or models, at any time and without prior notice.

Storage and/or Shipping Fees

According to the terms Logiflex set forth in the transport policy. The transport policy can be consulted online in the Private Space.

Items Delivered Disassembled

Madrid chairs are delivered disassembled.

Warranty

Logiflex guarantees to the original purchaser that Logiflex products are free from defects in design, materials and workmanship for the product's lifetime, with certain exceptions.

You may consult the full warranty on the website:

[Logiflex Warranty](#)

Introduction

How to Use the Price List

Interactive Menu

Product line: SIT - Bench
 Product group: Modular Seating
 Product name: SIT - Corner Bench with Back
 Product code: CBD

Product Information

Corner bench with short back (CBD)
 Corner bench with medium back (CBM)
 Corner bench with high back (CBH)

Manufacturing Standards

- Lacquered Russian plywood kick plate;
- 1" laminate construction;
- Firm density antibacterial foam;
- Single row of top stitching.

Kick Plate: Offered in the following 4 colors: Polar White, Mink Grey, Slate and Jet Black.

Dimensions:

Code	Total width	Total depth	Total height
CBD	26.75"	26.75"	29"
CBM	26.75"	26.75"	36"
CBH	26.75"	26.75"	48"

Number of yards for COM fabric:

Code	One fabric only	Combination of fabrics Bench	Back
CBD	4.5	2	2.75
CBM	5.25	2	3
CBH	6.25	2	4.5

Note: It is recommend that you include a layout with all orders and that you choose a solid fabric color for the bench portion.

Options

Connectivity **Connectivity Position**

MH3C MH3D L R LR

How to Order

SIT		Combination of Colors		Finishes		Fabric	
series	code	connectivity	position	kick plate	supplier	pattern	color
Example	SIT	CBD	MH3C	L	W	ENNIS	LOFT AQUA

Prices

Code	COM	GR1	GR2	GR3	GR4	GR5	GR6
CBD	****	****	****	****	****	****	****
CBM	****	****	****	****	****	****	****
CBH	****	****	****	****	****	****	****

Ordering instructions:

- Standard Product Code:** Details as per the price listed
- Options, if desired (\$):** Always after the product code
- Combination of Colors:** Laminate finishes and fabric choices

Navigation buttons: Previous View, Previous Page, Next Page, Product Map, Table of Contents

Additional Product Information and Notes: Product-specific manufacturing standards

Product Code: CBD, CBM, CBH

Prices: ****

Blue text hyperlink: See the Logiflex Graded-in List

Introduction



Appendix A: Colors and Finishes

How to specify your laminate colors

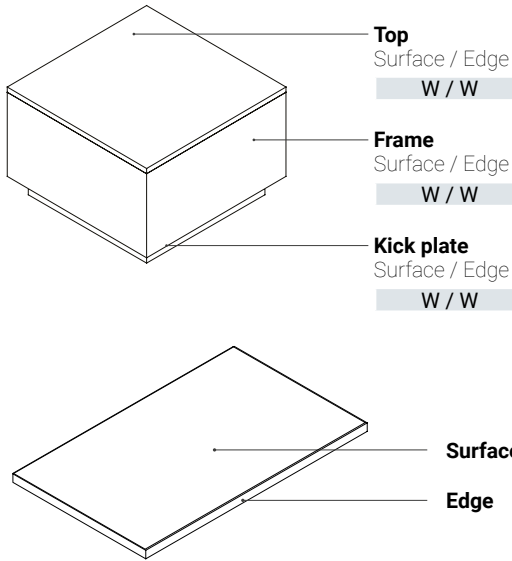

The edge is always the same color as the laminate surface color.

SIT Stretching Upholstery

To know which fabrics have been approved to be used in the SIT collection, refer to our [Upholstery Guide](#).

Availability Chart

FINI FINISH	CODE	COLOR COULEUR	THICKNESS ÉPAISSEUR			HPL	PANVAL CODE
			5/8"	1"	1-5/8"		
OMNIA	DOO	Dosha	•	•		•	K77
	COO	Cosmos	•	•		•	K78
AURA	GIA	Ginger Root Gingembre	•	•		•	H72
	HAA	Haze Brume	•	•	•	•	H57
	OHA	Ohm	•	•	•	•	K69
	STA	Storm Tempête	•	•	•	•	H58
	TUA	Tundra	•	•		•	H75
LYRA	ASY	Asha	•	•		•	K47
	CIY	Chiffon Mousseline **	•	•	•	•	K60
	KAY	Kali	•	•		•	K46
SUPERMAT	IGS	Ingot grey Gris lingot	•	•			828
	WGS	Willow grey Gris saule	•	•			802
DOLOMITE	AU	Audacity Audace **	•	•	•	•	241
	B	Jet Black Noir intense *	•	•		•	888 S405-CA
	BC	Brown cherry Cerisier brun	•	•	•	•	207
	C	Slate Ardoise *	•	•		•	801
	DR	Driftwood Bois de rive	•	•		•	744
	G	Mink Grey Gris vison	•	•		•	805 OU-927
	NM	Natural Maple Érable naturel	•	•	•	•	206
	PO	Porto	•	•		•	913 OU-648
	SW	Smoked Walnut Noyer fumé	•	•	•	•	G21
	TO	Tobacco	•	•		•	205
	W	Polar White Blanc polaire	•	•	•	•	555 459-CA
	WK	Whisky	•	•	•	•	245
	HIGH GLOSS SUPER LUSTRE	W-H	Polar White - fronts Blanc polaire - façades	•			

* Non recommended color for work surfaces.

** For conference tables with 2 or more parts, we do not recommend the use of colors with irregular and contrasted woodgrain like Chiffon, Audacity or Coastal Pear as it results in a pronounced wood grain mismatch.

Colors may vary from 2% to 5% between tfl and hpl laminates due to different technical applications.

See our complete [Colors & Finishes Guide](#)

New



Appendix A: Colors and Finishes

12 Wood Stains

Logiflex offers varnish and stain selection among the following 12 colors on all wood applications. The selection available may vary depending on the collections: please refer to the product pages for the selection available by collection. For example, the wooden Madrid chair is only available in Golden Wheat.

Knots and color variation can occur between different wood components of the same piece of furniture, or between different pieces of furniture. This variation is due to the natural characteristics of the wood, and is more contrasting for pale wood colors like Golden Wheat.



WW White Wash



GW Golden Wheat



SD Sand



AT Apricot



PN Pecan



BR Brandy



CT Chestnut



CF Coffee



ES Espresso



BO Bordeaux



BW Black Wash



BK Bark

Introduction



Appendix B: Upholstery Specification

Logiflex offers two options for upholstery specification:

Option 1 :	Customers may specify an upholstery from any supplier. Logiflex will then confirm upholstery grade and seat cost.
Option 2 :	Customers may select and purchase upholstery of their choice and ship upholstery to Logiflex (COM)

Option 1 : Specified Upholstery

Customers may consult the websites of our principal suppliers to visualize their complete product range. It is then possible to consult the graded-in list available on Logiflex.ca to be informed of the appropriate Logiflex grade.

Website of the upholstery supplier gives essential information to the maintenance, availability, quality and performance of the selected upholstery. In all cases, the upholstery supplier's warranty will apply.

Information to provide with the order:

Customer name
Purchase order number
Upholstery supplier name
Pattern name/number
Color name/number
Number of yards to order

Principal suppliers:

Momentum Textiles	themomgroup.com
Ennis Fabrics	ennisfabrics.com
Maharam	maharam.com
Designtex	designtex
Mayer Fabrics	mayerfabrics.com

See our Graded-In Program at:

logiflex.ca/medias/documents/logiflex-graded-in.pdf

Graded-in List:

Seat cost depends of selected upholstery. Grade is not established according to upholstery quality or performance, but to its purchase cost. In order to help customers researches, a graded-in list presenting the entire collections of Logiflex's principal suppliers has been prepared. It is possible to consult Logiflex graded-in list by visiting logiflex.ca

Note: The graded-in list is based on information at time of the publication of this document. As upholstery suppliers can discontinue products or increase their prices at their discretion, this list communicated for information purposes only and can not be considered as a sale commitment by Logiflex.

Option 2 : Customer's Own Material (COM)

Logiflex offers the option of providing your own upholstery. The price will be based on the cushion grade 2.

Orders with a COM fabric must be written clearly and indicate the color, pattern, width of the fabric and the manufacturer or distributor. The customer is responsible for providing a 12" x 12" sample to Logiflex for approval of the upholstery. Furthermore, Logiflex reserves the right to refuse any upholstery that does not meet Logiflex selection criteria.

COM fabrics must be delivered to the Logiflex factory with freight and duties paid. For COM orders, the order's delivery date is set once the fabric is received by Logiflex. All charges to COM acquisition on the customer's behalf will be passed onto the customer.

Logiflex does not assume responsibility for upholstery availability, quality, performance or appearance. In addition, the Logiflex warranty excludes customer's own materials.

COM upholstery delivery:

The following information must be included with the COM upholstery delivery and be communicated to the account manager along with the purchase order:

Customer name
Purchase order number
Upholstery supplier name
Pattern name/number
Color name/number
Number of yards delivered

Shipping address:

Logiflex
Attn: Receiver
1235 St-Roch North Road
Sherbrooke Quebec
Canada J1N 0H2

Note: A late reception of fabric may cause delivery delays.

Upholstery Quantities:

The quantities of fabric yardage to order for each piece of furniture is indicated in the "Manufacturing Standard" section on the product page indicating the amount of yards required.

Where this option is available, you will see the following table in the "Manufacturing Standard" section on the product page indicating the amount of yards required:

Example:

Number of yards for COM fabric:

Code	Total	Back	Seat	Frame
BD	3.25	1.25	2	1.25
BM	3.5	1.75	2	1.25
BH	4	2.25	2	1.25

Note: It is recommend that you include a layout with all orders and that you choose a solid fabric color for the seat portion.



Appendix B: Upholstery Specification *(continued)*

Seams

Different top stitchings are available for different armchair models.

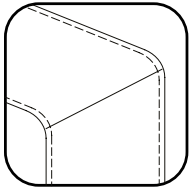

PQS

Single Top Stitch

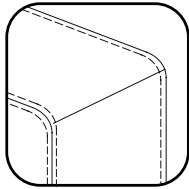

PQD

Double Top
Stitch

Combining Fabrics

Different fabrics can be specified for the bench and back of the same seat at no extra cost.

Where this option is available, you will see the **Combination of Colors** indicator illustrations.

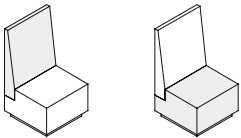

Example:

Backrest: ENNIS / BALANCE / #9009 GR1

Seat: ENNIS / ORNAMENTAL / #302 GR3

The price will be that of the highest-grade fabric chosen.

Application of Upholstery

Application of upholstery will follow the directional orientation of its pattern. Explicit instructions must be given to the customer's account manager if a specific direction is desired. Logiflex will not be responsible of problems related to upholstery direction or positioning unless formal instructions has been given along with the purchase order.

Instruction references:

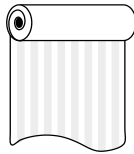

Up the Roll

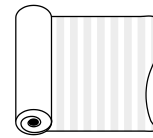

Railroaded
(across the roll)

Leather

All leathers used are "cowhide".

Please note that the warranty does not apply on leather's natural imperfections, such as: scars, marks, and difference in stain within a leather skin or different skins. This specification also applies for standard leather GR5 and Italian leather GR7 and up.

Polyurethane foam

The polyurethane foam used in the manufacturing of our armchairs is antibacterial.

Different densities exist and will vary from one armchair model to the other. Medium-density foam is used for back and seating parts, while the firmer-density foam is used for armrest parts.

CAL 117 Flammability standards

The foam used meets or exceeds the flammability standards of the California Technical Bulletin 117 norms.

CAL 133 Flammability standards

It is possible to order chairs or soft seating that comply with the technical bulletin California 133 (CAL 133) used primarily in public buildings without sprinkler systems. In order to be compliant, the fabrics must be certified CAL 117 and a fire blocking material, which prevents fire from spreading, must be installed under the fabric by Logiflex.

To obtain a certificate from an independent laboratory, you must pay the price of the compliant product to be tested plus a cost to cover the transportation, testing and the issuing of the certificate

Customers interested in ordering a CAL 133 compliant product are encouraged to contact customer service for pricing and instructions.

Introduction



Appendix C : SIT

Manufacturing Standards

Levelers

All modules with a kick plate sit on white nylon levelers.

Fasteners

All modules with a kick plate come with 2 fasteners to join to other modules.

Dimensions

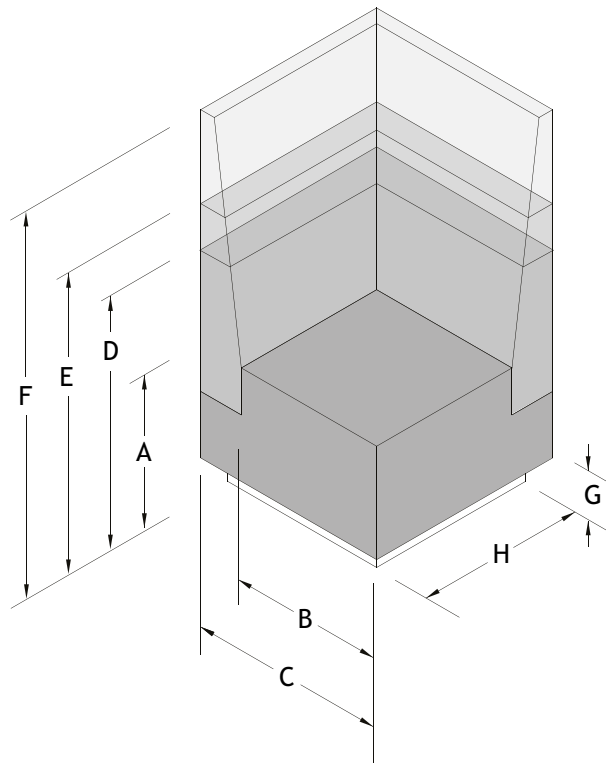

A. Bench height	18" *
B. Bench depth to back	20-3/4" *
C. Bench depth to panel	26-3/4" *
D. Short back height	29"
E. Medium back height	36"
F. High back height	48"
G. Kick plate height (Angle of back 8°)	3-1/2"
H. Kick plate width	22"

* Dimensions may vary depending on selected fabric thickness.

Wiring Management

All kick plates include a half-round machine-cut on all four sides for feeding cables from one module to the next.

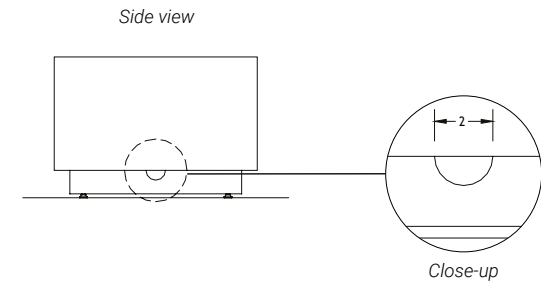

Installation example

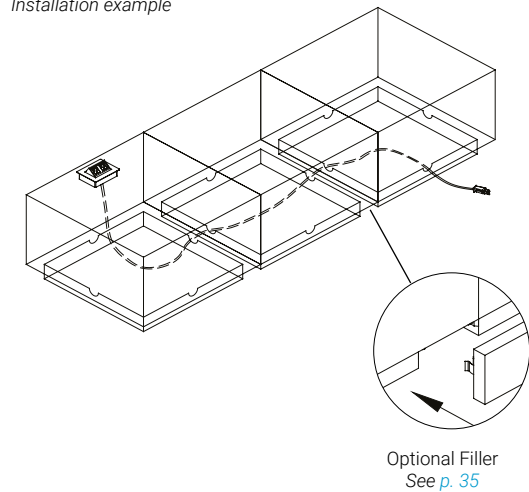

Introduction



Appendix C : SIT

MH3 - Connectivity - positions

Benches and tables

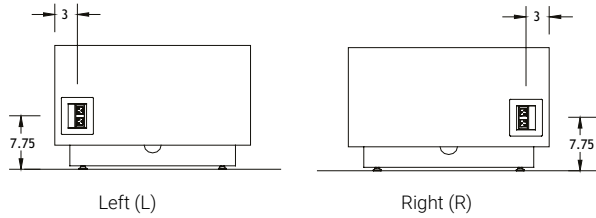

Benches with notch(es)

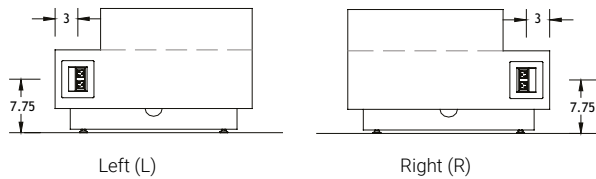
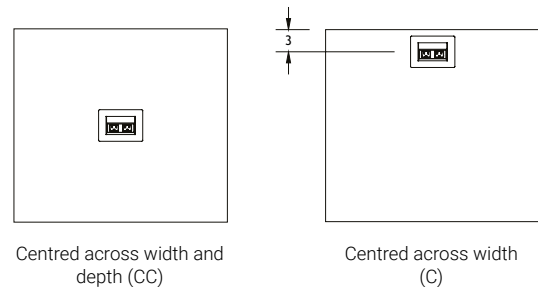
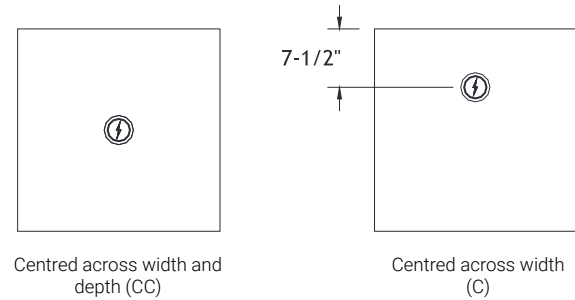

Table tops



Qi - Connectivity - positions



Appendix D : Kick plate Colors

Logiflex offers a selection among the following colors for the SIT collection kick plates:



Appendix E : Wood Color Selection

Logiflex offers varnish and stain selection among the following colors:

- GW** Golden Wheat
- WW** White Wash
- CT** Chestnut
- ES** Espresso
- AT** Apricot
- BW** Black Wash
- PN** Pecan
- CF** Coffee
- BR** Brandy
- BK** Bark
- SD** Sand
- BO** Bordeaux

* Madrid chairs are only available in Golden Wheat (GW)



Appendix F : Backs/Seats Options for Chairs

Seat Width

Available for chairs:

Width	Cyrus	Texto	Texto Mesh	Texto Lab	Elie
Narrow seat		TX1			
Standard seat		TX2	TXM2		
Large seat		TX3	TXM3		

● Not available for chairs with stool height.



- 1 Narrow seat (-2")**
- Width seat: 17"
 - Width backrest: 16 1/2"
 - Depth seat: 17"

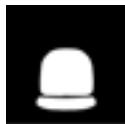

- 2 Standard seat**
- Width seat: 19"
 - Width backrest: 18 1/2"
 - Depth seat: 18"



- 3 Large seat (+2")**
- Width seat: 21"
 - Width backrest: 18 1/2"
 - Depth seat: 18"
 - "Heavy duty" type cylinder with a thrust of 450 Newton.
 - Reinforced fixing of the backrest bar to the structure.
- \$145

Back Height

Available for chairs:

Height	Cyrus	Texto	Texto Mesh	Texto Lab	Elie
L - Low		o		o	
M - Medium		o			o
D - Director		o			
H - High		o			o
T - T Shaped back				o	
C - Contour back				o	
X - No back				o	

*For backrest heights, see product pages



L Low back

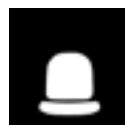

M Medium back



D Director back



H High back with headrest



T T shaped back



C Contour back



X No back



Appendix G : Base Options for Chairs

Chairs Options

Available for chairs:

Code	Cyrus	Texto	Texto Mesh	Texto Lab	Elie
VN	o	o	o		o
ZN	o	o	o	o	o
VC	o	o	o		o
ZC	o	o	o	o	o
TN		o	o	o	
TC		o	o	o	
01	o	o	o		o



VN Black nylon tapered base
 • 27" diameter



ZN Black nylon rounded base
 • 27" diameter



VC Aluminum tapered base
 • 27" diameter
 \$145



ZC Aluminum rounded base
 • 27" diameter
 \$145



TN Black nylon rounded stool base
 • 27" diameter
 • 10 5/8" cylinder
 • 60° footrest, 20" diameter
 • Height-adjustable



TC Aluminum rounded stool base
 • 27" diameter
 • 10 5/8" cylinder
 • 360° footrest, 20" diameter
 • Height-adjustable
 \$145



01 Sled base

Appendix H : Mechanism Options for Chairs

Mechanisms

Available for chairs:

Code	Cyrus	Texto	Texto Mesh	Texto Lab	Elie
10		o	o		o
11		o	o	o	o
20		o	o		o
21		o	o		o
31		o	o	o	o
41	o	o	o		o
51		o	o	o	o
71		o	o		
76F		o			

* Mechanisms 31 and 51 for stools: the tilt function is not included for safety reasons. Only the mechanism 51 allows adjustment of the seat angle.



Mechanism 10

- Adjustable height (screw)
- 360° swivel on column axis



Mechanism 11 13

- Adjustable height (gas cylinder)
- 360° swivel on column axis



Mechanism 31

- Adjustable height (gas cylinder)
- 360° swivel on column axis
- Backward tilt from 3° to 18° (center pivot)
- Adjustable tilt tension
- Tilt lock to one position, at 3°
- Adjustable angle on back from 86° to 121°

\$25



Mechanism 41

- Adjustable height (gas cylinder)
- 360° swivel on column axis
- Synchro tilt of seat from -1° to 10° (center pivot) and of back from 90° to 110°
- Adjustable tilt tension
- Tilt lock in 5 positions

\$50



Mechanism 20

- Adjustable height (screw)
- 360° swivel on column axis
- Tilt lock to one position, at 3°

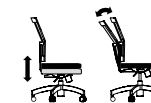

Mechanism 21

- Adjustable height (gas cylinder)
- 360° swivel on column axis
- Tilt lock to one position, at 3°
- Backward tilt from 3° to 20° (center pivot)



Mechanism 51

- Adjustable height (gas cylinder)
- 360° swivel on column axis
- Backward tilt from 3° to 17° (center pivot)
- Adjustable tilt tension
- Tilt lock in all positions
- Adjustable backrest angle from 80° to 108°

\$50



Mechanism 71

- 360° swivel on column axis.
- Adjustable height (gas cylinder)
- 20° backward tilt starting from initial position adjustable between -4° to 5°
- Adjustable tilt tension
- Tilt lock in all positions
- Adjustable backrest angle from 89° to 105°

\$105



Mechanism 76F

- Adjustable height (gas cylinder)
- 360° swivel on column axis
- 20° backward tilt starting from initial position adjustable between -4° to 5°
- Adjustable tilt tension
- Tilt lock in all positions
- Adjustable backrest angle from 89° to 105°
- Adjustable depthseat of 2-1/2"
- Adjustable backrest of 4"

\$155



Appendix I : Chairs Options

Options

Available for chairs:

Code	Cyrus	Texto	Texto Mesh	Texto Lab	Elie
R		o	o	o	
S		o	o		o
F		o			

R Back height adjustment option

This option allows a backrest adjustment of 3". The option is available on certain mechanisms only, add "R" after the mechanism code (ex. mechanism #21 becomes #21R).

\$30

S Seat sliding option

This option allows a front-to-back sliding seat adjustment of 2 ½", to adjust the seat depth. The option is available on certain mechanisms only, add "S" after the mechanism code (ex. mechanism #21 becomes #21S) and add \$72. Not available on X-Large seat widths.

\$75

F Combined options

Backrest height adjustment & sliding seat. The option is available on certain mechanisms only, add "F" after the mechanism code (ex. mechanism #21 becomes #21F) and add \$99. Not available on X-Large seat widths.

\$105

Introduction

Appendix J : Arms Options for Chairs

Arms

Available for chairs:

Code	Cyrus	Texto	Texto Mesh	Texto Lab	Elie
NA	o	o	o		o
AD	o	o	o		o
AG		o	o		
AP		o	o		
AR		o	o		
AS	o	o	o		o
AW		o	o		
AX		o	o		
AY		o	o		
AZ	o	o	o		o
FD	o	o	o		o
FG	o	o	o		o
FT		o	o		o
FZ	o	o	o		o
F7	o				
F61	o				

No Arm



- NA**
- No arm

Adjustable Arms



AG \$125



AP \$125



AR \$125

Adjustable arms

- Black nylon arm, steel attachment with urethane armrest.
- Medium firmness (3/5).
- Height adjustment of 3" using a lever.
- 3" width adjustment.



AD \$125

Adjustable arms

- Black nylon arm, steel attachment with urethane armrest.
- Medium firmness (3/5).
- Height adjustment of 3" using a lever.



AX \$200

Adjustable arms with multi-axis armrests

- Black nylon arm, steel attachment with urethane armrest.
- Medium firmness (3/5).
- Height adjustment of 3" using a lever.
- 3" width adjustment.



AS \$125

Adjustable arms

- Black nylon arm, steel attachment with urethane armrest.
- Medium firmness (3/5).
- Height adjustment of 3" using a push button.



AY \$200

Adjustable arms with multi-axis and pivot armrests

- Black nylon arm, steel attachment with urethane armrest.
- Medium firmness (3/5).
- Height adjustment of 3" using a lever.
- Lateral and front-to-back armrest adjustment.
- Pivot of -30° to +30°.
- 3" width adjustment on certain models.



AW \$125

Adjustable arms with pivot

- Black nylon arm, steel attachment with urethane armrest.
- Medium firmness (3/5).
- Height adjustment of 3" using a lever.
- Pivot of -30° to +30°.
- 3" width adjustment.



AZ \$255

Adjustable arms with multi-axis and pivot armrests

- Black nylon arm, polished aluminum attachment with urethane armrest.
- Medium firmness (3/5).
- Height adjustment of 2 3/4" using a push button.
- Pivot of -30° to +30°.
- Front/back adjustment of 2".



Appendix J : Arms Options for Chairs

Fixed Arms



FD \$125



FG \$125

Open/Closed fixed arms

- Reinforced steel frame covered in urethane.
- Medium firmness (4/5).
- 3" width adjustment on certain models.



FT \$125

Open curved fixed arms

- Reinforced steel frame covered in urethane.
- Medium firmness (3/5).
- 3" width adjustment on certain models



FZ \$255

Fixed arms

- Polished aluminum frame arm.
- Medium firmness (4/5).
- Armrest upholstered with the same fabric as the chair.
- Not adjustable.



F7 \$255

Fixed aluminum arms

- Black polyurethane cover



F61 \$125

Fixed T shaped arm

- Black polyurethane pad



Appendix K : Legs Chairs Options

Legs

Available for chairs:

Code	Cyrus	Texto	Texto Mesh	Texto Lab	Elie	Madrid
H	o	o	o	o	o	
S	o	o	o	o	o	
G	o	o	o	o	o	
M		o	o	o		
T						o



H Casters for carpeting

- Lightly textured black nylon.
- 2" diameter with double drum.
- For VN and VC bases, the caster has a 2 3/8" diameter.



M Mixed (3 casters, 2 glides)

- For 5-prong bases for stools (TN, TC and TB), a mixed option can be specified: 3 "H" casters and 2 "G" glides will be installed on the base.



S Casters for hard surfaces

- Lightly textured black nylon.
- 2" diameter with double drum.
- The center of the caster is nylon covered in ultra-soft urethane for a smoother rolling motion.
- For VN and VC bases, the caster has a 2 3/8" diameter



T Teflon glides



G Nylon glides

- Lightly textured black nylon.
- 2" high.
- On VN and VC bases, the glide is 2 3/8" high.

Modular Seating

SIT - Bench

B

Bench with kick plate

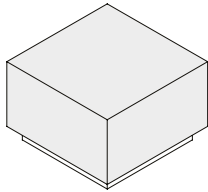

BC

Bench with ball casters

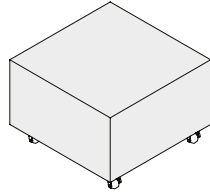

Manufacturing Standards

- **B**: Lacquered Russian plywood kick plate;
- **BC**: 4 Ball casters with breaks;
- 1" laminate construction;
- Firm density antibacterial foam;
- Single row of top stitching.

Note: MH3 are not available on the bench with ball casters.

Kick Plate: Offered in the following 4 colors: Polar White, Mink Grey, Slate and Jet Black.

Dimensions:

Code	Total width	Total depth	Total height
B	26.25"	26.25"	18"
BC	26.25"	26.25"	18"

Number of yards for COM fabric:

Code	Total	Seat	Frame
B	1.75	.75	1.25
BC	1.75	.75	1.25

Note: It is recommend that you include a layout with all orders.

Combination of Colors

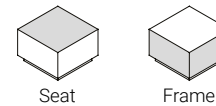

Options

Connectivity



\$397 \$397

Connectivity Position

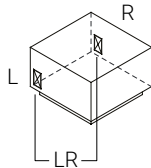

Prices

Code	GRA	GR1	COM GR2	GR3	GR4	GR5	GR6	GR7	GR8	GR9	GR10	GR11	GR12	Cuir Leather
B	976	1005	1044	1082	1130	1178	1226	1275	1323	1371	1419	1515	1611	1531
BC	944	973	1012	1050	1098	1146	1194	1243	1291	1339	1387	1483	1579	1499

How to Order

SIT	B BC	MH3C MH3D	L R LR	Combination of Colors				
				Finishes	Fabric <i>See the Logiflex Graded-in List</i>			
series	code	connectivity	position	kick plate	supplier	pattern	color	
Example	SIT	B	MH3C	L	W	ENNIS	LOFT	AQUA

Modular Seating

SIT - Bench with Back

BD

Bench with short back

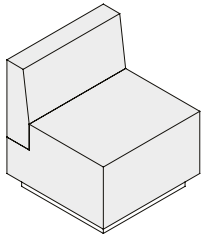

BM

Bench with medium back

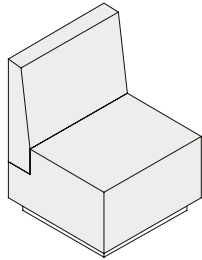

BH

Bench with high back

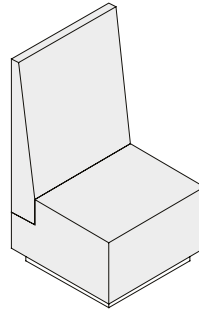

Manufacturing Standards

- Lacquered Russian plywood kick plate;
- 1" laminate construction;
- Firm density antibacterial foam;
- Single row of top stitching.

Kick Plate: Offered in the following 4 colors: Polar White, Mink Grey, Slate and Jet Black.

Dimensions:

Code	Total width	Total depth	Total height
BD	26.25"	26.25"	29"
BM	26.25"	26.25"	36"
BH	26.25"	26.25"	48"

Number of yards for COM fabric:

Code	Total	Back	Seat	Frame
BD	3.25	1.25	1	1.25
BM	3.5	1.75	1	1.25
BH	4	2.25	1	1.25

Note: It is recommended that you include a layout with all orders and that you choose a solid fabric color for the seat portion.

Combination of Colors

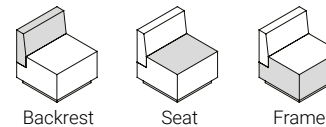

Options

Connectivity



\$397 \$397

Connectivity Position

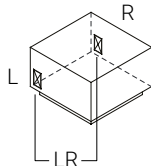

Prices

Code	GRA	GR1	COM GR2	GR3	GR4	GR5	GR6	GR7	GR8	GR9	GR10	GR11	GR12	Cuir Leather
BD	1318	1372	1444	1515	1604	1694	1783	1873	1962	2051	2141	2319	2498	2349
BM	1408	1466	1543	1620	1716	1813	1909	2005	2101	2198	2294	2486	2679	2518
BH	1480	1546	1634	1722	1832	1942	2052	2162	2272	2382	2492	2712	2932	2749

How to Order

SIT	BD BM BH	MH3C MH3D	L R LR	Combination of Colors				
				Finishes	Fabric <i>See the Logiflex Graded-in List</i>			
series	code	connectivity	position	kick plate	supplier	pattern	color	
Example	SIT	BD	MH3C	L	W	ENNIS	LOFT	AQUA

Modular Seating

SIT - Corner Bench with Back

CBD

Corner bench with short back

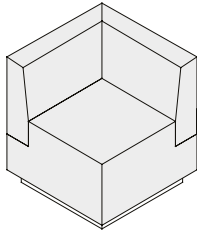

CBM

Corner bench with medium back

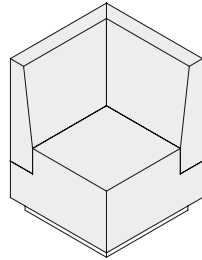

CBH

Corner bench with high back

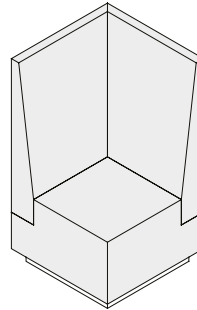

Manufacturing Standards

- Lacquered Russian plywood kick plate;
- 1" laminate construction;
- Firm density antibacterial foam;
- Single row of top stitching.

Kick Plate: Offered in the following 4 colors: Polar White, Mink Grey, Slate and Jet Black.

Dimensions:

Code	Total width	Total depth	Total height
CBD	26.25"	26.25"	29"
CBM	26.25"	26.25"	36"
CBH	26.25"	26.25"	48"

Number of yards for COM fabric:

Code	Total	Backrest	Seat	Frame
CBD	4.5	2.75	.75	1.25
CBM	5.25	3	.75	1.25
CBH	6.25	4.5	.75	1.25

Note: It is recommend that you include a layout with all orders and that you choose a solid fabric color for the seat portion.

Combination of Colors

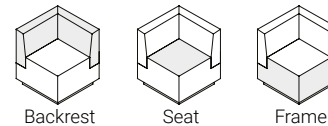

Options

Connectivity



\$397 \$397

Connectivity Position

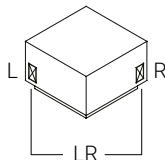

Prices

Code	GRA	GR1	COM GR2	GR3	GR4	GR5	GR6	GR7	GR8	GR9	GR10	GR11	GR12	Cuir Leather
CBD	1589	1663	1762	1861	1985	2109	2232	2356	2480	2604	2727	2975	3222	3016
CBM	1985	2072	2188	2303	2447	2592	2736	2881	3025	3169	3314	3602	3891	3651
CBH	2220	2323	2461	2598	2770	2942	3114	3286	3457	3629	3801	4145	4489	4202

How to Order

SIT	CBD CBM CBH	MH3C MH3D	L R LR	Combination of Colors				
				Finishes	Fabric <i>See the Logiflex Graded-in List</i>			
series	code	connectivity	position	kick plate	supplier	pattern	color	
Example	SIT	CBD	MH3C	L	W	ENNIS	LOFT	AQUA

Modular Seating

SIT - Occasional Table with Laminate Frame

T

Laminate frame

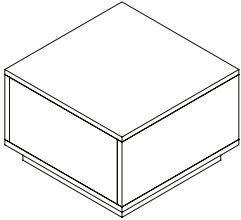

Combination of Colors

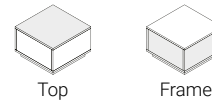

Manufacturing Standards

- 1" laminate top and frame;
- Lacquered Russian plywood kick plate;
- 1" laminate construction.

Kick Plate: Offered in the following 4 colors: Polar White, Mink Grey, Slate and Jet Black.

Dimensions:

Code	Total width	Total depth	Total height
T	26.25"	26.25"	18"

Note: It is recommend that you include a layout with all orders.

Options

Marker Board



MB
\$222

Connectivity



\$397 \$397

Connectivity Position

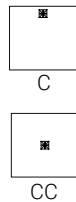
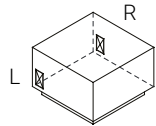

Air Charger

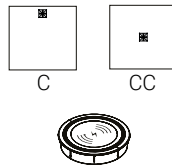

\$617

How to Order

							Combination of Colors			
							Finishes <i>See the Logiflex Color Guide</i>			
SIT	T	MB	MH3C MH3D	L R C CC	QIBL	C CC				
series	code	marker board	connectivity	position	Qi (Appx. B)	Qi position	top	frame	kick plate	
Example	SIT	T	MB	MH3C	L	QIBL	CC	W	W	W

Modular Seating

SIT - Occasional Table with Fabric Frame

FT

Fabric frame

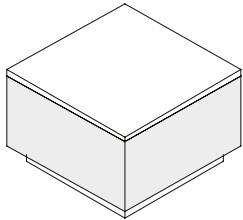

Combination of Colors

Laminate Fabric

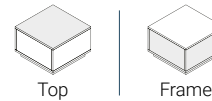

Manufacturing Standards

- 1" laminate top;
- Fabric frame
- Lacquered Russian plywood kick plate;
- 1" laminate construction.

Kick Plate: Offered in the following 4 colors: Polar White, Mink Grey, Slate and Jet Black.

Dimensions:

Code	Total width	Total depth	Total height
FT	26.25"	26.25"	18"

Number of yards for COM fabric:

Code	Total	Frame
FT	1.25	1.25

Note: It is recommend that you include a layout with all orders.

Options

Marker Board



MB
\$222

Connectivity



\$397



\$397

Connectivity Position

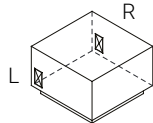

C



CC

Air Charger

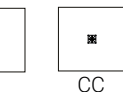

\$617

Prices

Code	GRA	GR1	COM GR2	GR3	GR4	GR5	GR6	GR7	GR8	GR9	GR10	GR11	GR12	Cuir Leather
FT	802	823	851	878	912	947	981	1016	1050	1084	1119	1187	1256	1199

How to Order

		Combination of Colors										
SIT	FT	MB	MH3C MH3D	L R C CC	QIBL	C CC	Finishes <i>See the Logiflex Color Guide</i>		Fabric <i>See the Logiflex Graded-in List</i>			
series	code	marker board	connectivity	position	Qi (Appx. B)	Qi position	top	kick plate	supplier	pattern	color	
Example	SIT	FT	MB	MH3C	L	QIBL	CC	W	W	ENNIS	LOFT	AQUA

Modular Seating

SIT - Bookshelf Tables with Laminate Frame

TB1

Open on 1 side

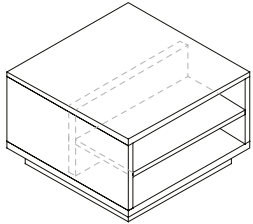

TB2

Open on 2 sides

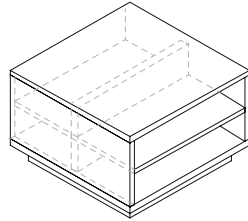

Combination of Colors

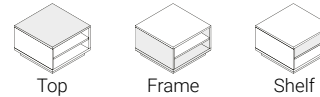

Manufacturing Standards

- 1" laminate top;
- Bookshelf with 1 fixed shelf per open side;
- Vertical central separator;
- Lacquered Russian plywood kick plate;
- 1" laminate construction.

Kick Plate: Offered in the following 4 colors: Polar White, Mink Grey, Slate and Jet Black.

Dimensions:

Code	Total width	Total depth	Total height
TB1	26.25"	26.25"	18"
TB2	26.25"	26.25"	18"

Note: It is recommend that you include a layout with all orders.

Options

Marker Board



MB
\$222

Prices

Code	Price
TB1	799
TB2	799

How to Order

TB1
TB2

+

MB

Combination of Colors

Finishes
See the Logiflex Color Guide

SIT	top	frame	shelf	kick plate
series				
code				
marker board				

Example SIT TB1 MB W W W W

Modular Seating

SIT - Occasional Table with Laminate Frame on Casters

TC

Laminate frame

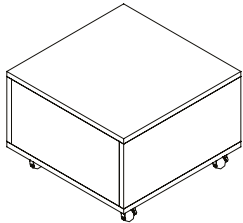

Manufacturing Standards

- 1" laminate top and frame;
- Four ball castors with breaks;
- 1" laminate construction.

Dimensions:

Code	Total width	Total depth	Total height
TC	26.25"	26.25"	18"

Note: It is recommend that you include a layout with all orders.

Combination of Colors

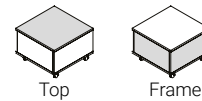

Options

Marker Board



MB
\$222

Prices

Code	Price
TC	705

How to Order



Combination of Colors

Finishes

[See the Logiflex Color Guide](#)

SIT	TC	MB	top	frame	
series	code	marker board			
Example	SIT	TC	MB	W	W

Modular Seating

SIT - Occasional Table with Fabric Frame on Casters

FTC

Fabric frame

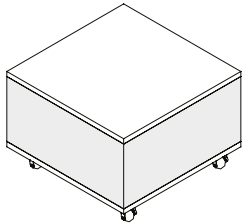

Manufacturing Standards

- 1" laminate top;
- Fabric frame
- Four ball castors with breaks;
- 1" laminate construction.

Dimensions:

Code	Total width	Total depth	Total height
FTC	26.25"	26.25"	18"

Number of yards for COM fabric:

Code	Total	Frame
FTC	1.25	1.25

Combination of Colors

Laminate | Fabric

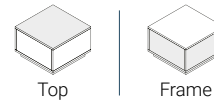

Options

Marker Board



MB
\$222

Prices

Code	GRA	GR1	COM GR2	GR3	GR4	GR5	GR6	GR7	GR8	GR9	GR10	GR11	GR12	Cuir Leather
FTC	790	811	839	866	900	935	969	1004	1038	1072	1107	1175	1244	1187

How to Order



Combination of Colors

Finishes
See the
Logiflex Color
Guide

Fabric
See the Logiflex Graded-in List

SIT	FTC	MB	Combination of Colors			
series	code	marker board	top	supplier	pattern	color
Example SIT	FTC	MB	W	ENNIS	LOFT	AQUA

Modular Seating

SIT - Bookshelf Tables with Laminate Frame on Casters

TBC2

Open on 2 sides

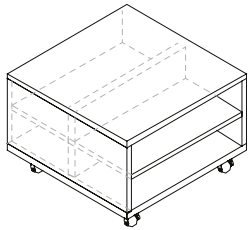

Combination of Colors

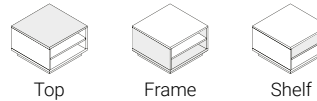

Top

Frame

Shelf

Manufacturing Standards

- 1" laminate top;
- Bookshelf with 1 fixed shelf per open side;
- Vertical central separator;
- Four ball castors with breaks;
- 1" laminate construction.

Dimensions:

Code	Total width	Total depth	Total height
TBC2	26.25"	26.25"	18"

Note: It is recommend that you include a layout with all orders.

Options

Marker Board



MB
\$222

Prices

Code	
TBC2	714

How to Order



Combination of Colors

Finishes [See the Logiflex Color Guide](#)

SIT	TBC2	MB			
series	code	marker board	top	frame	shelf
SIT	TBC2	MB	W	W	W

Example

Modular Seating

SIT - Bench with Fabric Frame and Built-in Table with Laminate Frame

26BT

Laminate frame table

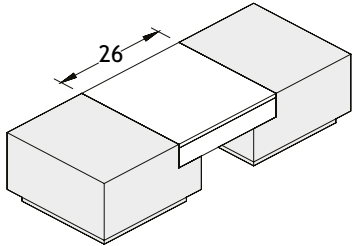

38BT

Laminate frame table

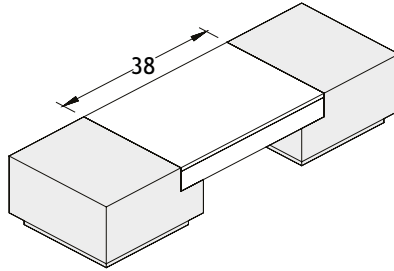

Manufacturing Standards

- 1" laminate top;
- 2 fabric benches;
- 1 built-in table with 1" 1" laminate top and frame;
- Lacquered Russian plywood kick plate;
- Firm density antibacterial foam;
- 1" laminate construction.

Kick Plate: Offered in the following 4 colors: Polar White, Mink Grey, Slate and Jet Black.

Dimensions:

Code	Largeur totale	Profondeur totale	Total height	Table length
26BT	66"	26.25"	18"	26"
38BT	78"	26.25"	18"	38"

Number of yards for COM fabric:

Code	Total	Seat	Frame
26BT	2.75	1	2.25
38BT	2.75	1	2.25

Note: It is recommend that you include a layout with all orders and that you choose a solid fabric color for the seat portion.

Combination of Colors

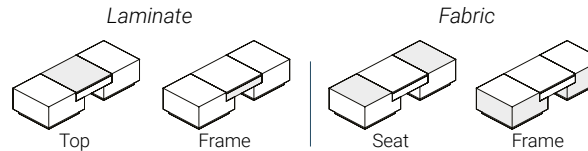

Options

Connectivity



\$397 \$397

Connectivity Position



Left



Right



C



CC

Air Charger



C



CC



\$617

\$

Prices

Code	GRA	GR1	COM GR2	GR3	GR4	GR5	GR6	GR7	GR8	GR9	GR10	GR11	GR12	Cuir Leather
26BT	2056	2101	2162	2222	2298	2373	2449	2525	2600	2676	2751	2903	3054	2928
38BT	2132	2177	2238	2298	2374	2449	2525	2601	2676	2752	2827	2979	3130	3004

How to Order

Combination of Colors

Finishes
See the Logiflex Color Guide

Fabric
See the Logiflex Graded-in List

SIT	26BT 38BT	MH3C MH3D	L R C CC	QIBL	C CC	top	frame	kick plate	supplier	pattern	color	
series	code	connectivity	position	Qi (Appx. B)	Qi position							
Example	SIT	26BT	MH3C	L	QIBL	CC	W	W	W	ENNIS	LOFT	AQUA

Modular Seating

SIT - Bench with Fabric Frame and Built-in Table with Fabric Frame

26BFT

Fabric frame table

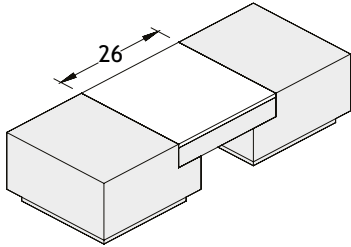

38BFT

Fabric frame table

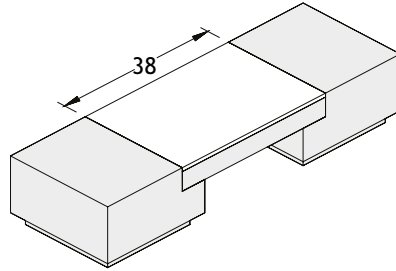

Manufacturing Standards

- 1" laminate top;
- 2 fabric benches;
- 1 built-in table with 1" laminate top and fabric frame;
- Lacquered Russian plywood kick plate;
- Firm density antibacterial foam;
- 1" laminate construction.

Kick Plate: Offered in the following 4 colors: Polar White, Mink Grey, Slate and Jet Black.

Dimensions:

Code	Largeur totale	Profondeur totale	Total height	Table length
26BFT	66"	26.25"	18"	26"
38BFT	78"	26.25"	18"	38"

Number of yards for COM fabric:

Code	Total	Seat	Frame
26BFT	3.5	1	2.5
38BFT	3.75	1	2.75

Note: It is recommend that you include a layout with all orders and that you choose a solid fabric color for the seat portion.

Combination of Colors

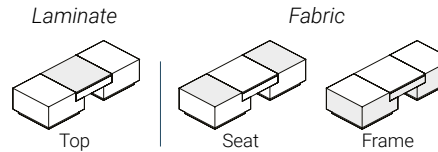

Options

Connectivity



\$397



\$397

Connectivity Position



Left



Right



C



CC

Air Charger



C



CC



\$617

\$

Prices

Code	GRA	GR1	COM GR2	GR3	GR4	GR5	GR6	GR7	GR8	GR9	GR10	GR11	GR12	Cuir Leather
26BFT	2484	2542	2619	2696	2792	2889	2985	3081	3177	3274	3370	3562	3755	3594
38BFT	2530	2592	2675	2757	2860	2963	3066	3170	3273	3376	3479	3685	3891	3720

How to Order

						Combination of Colors					
						Finishes		Fabric			
						See the Logiflex Color Guide		See the Logiflex Graded-in List			
SIT	26BFT 38BFT	MH3C MH3D	L R C CC	QIBL	C CC	top	kick plate	supplier	pattern	color	
series	code	connectivity	position	Qi (Appx. B)	Qi position						
Example	SIT	26BFT	MH3C	L	QIBL	CC	W	W	ENNIS	LOFT	AQUA

Modular Seating

SIT - Space Filler for Benches

FILLER4

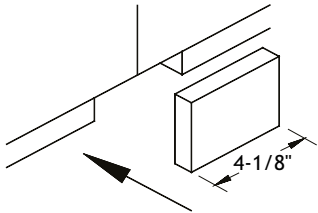

Manufacturing Standards

- 4-1/8" removable joint for junctions between kick plates;
- Lacquered Russian plywood.

Note: For best results, order 2 fillers for each module junction.

Prices

Code	
FILLER4	39

How to Order

FILLER4

code

Example **FILLER4**

Modular Seating

Infiniti - Square Bench

BC26

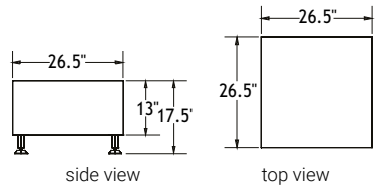
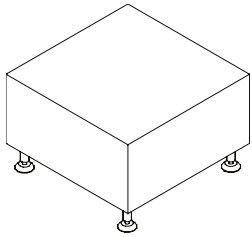

Manufacturing Standards

- 4 brushed chrome metal legs;
- Single top stitching;
- Elastic straps on seat;
- Firm density foam on seat;
- 1/2" thick polyester on the sides of the frame;
- Frame made out of plywood and hardwood..

Combination of Colors

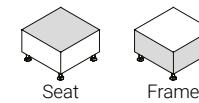

Number of yards for COM fabric:

Code	Total	Seat	Frame
BC26	2.5	.75	1.75

Note: It is recommend that you include a layout with all orders and that you choose a solid fabric color for the seat portion.



Prices

Code	GRA	GR1	COM GR2	GR3	GR4	GR5	GR6	GR7	GR8	GR9	GR10	GR11	GR12	Cuir Leather
BC26	929	970	1025	1080	1149	1218	1286	1355	1424	1493	1561	1699	1836	1722

How to Order

Fabric
See the Logiflex Graded-in List

SS	BC26	PQS			
series	code	top stitching	supplier	pattern	color

Example **SS** **BC26** **PQS** **ENNIS** **LOFT** **AQUA**

Modular Seating

Infiniti - Arched Bench

BA26

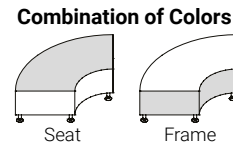
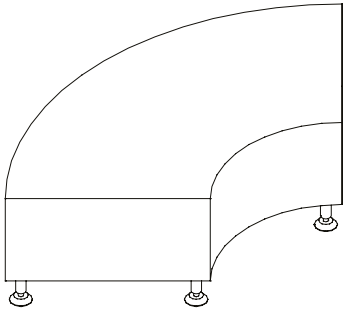

Manufacturing Standards

- 5 brushed chrome metal legs;
- Single top stitching;
- Elastic straps on seat;
- Firm density foam on seat;
- 1/2" thick polyester on the sides of the frame;
- Frame made out of plywood and hardwood..

Number of yards for COM fabric:

Code	Total	Seat	Frame
BA26	3	1.75	1.75

Note: It is recommend that you include a layout with all orders and that you choose a solid fabric color for the seat portion.

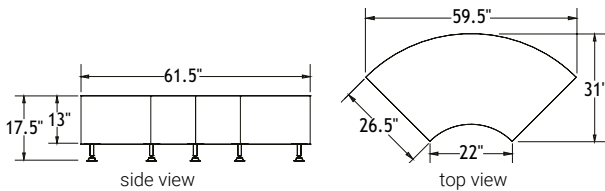

Prices

Code	GRA	GR1	COM	GR2	GR3	GR4	GR5	GR6	GR7	GR8	GR9	GR10	GR11	GR12	Cuir Leather
BA26	1585	1635	1701	1767	1850	1932	2015	2097	2180	2262	2345	2510	2675	2537	

How to Order

Fabric
See the Logiflex Graded-in List

SS	BA26	PQS			
series	code	top stitching	supplier	pattern	color

Example SS BA26 PQS ENNIS LOFT AQUA

Modular Seating

Infiniti - Oval Bench

B026

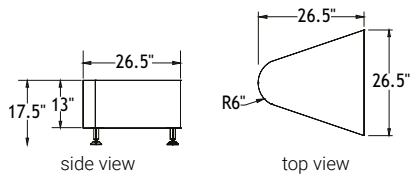
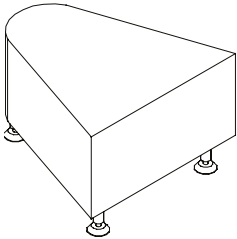

Manufacturing Standards

- 3 brushed chrome metal legs;
- Single top stitching;
- Elastic straps on seat;
- Firm density foam on seat;
- 1/2" thick polyester on the sides of the frame;
- Frame made out of plywood and hardwood..

Combination of Colors

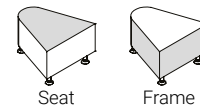

Number of yards for COM fabric:

Code	Total	Seat	Base
B026	2.25	1	1.25

Note: It is recommend that you include a layout with all orders and that you choose a solid fabric color for the seat portion.



Prices

Code	GRA	GR1	COM GR2	GR3	GR4	GR5	GR6	GR7	GR8	GR9	GR10	GR11	GR12	Cuir Leather
B026	889	926	976	1025	1087	1149	1211	1273	1334	1396	1458	1582	1706	1603

How to Order

Fabric
See the Logiflex Graded-in List

SS	B026	PQS			
series	code	top stitching	supplier	pattern	color

Example

SS	B026	PQS	ENNIS	LOFT	AQUA
----	------	-----	-------	------	------

Modular Seating

Infiniti - Square Bench with Padded Arm

BCB26

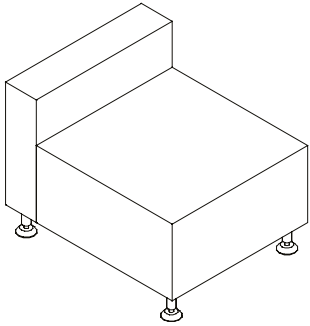

Combination of Colors

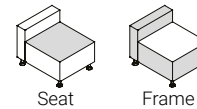

Manufacturing Standards

- 4 brushed chrome metal legs;
- Single top stitching;
- Elastic straps on seat;
- Firm density foam on seat and frame;
- 1/2" thick polyester on the sides of the frame;
- Seat and frame made out of recycled materials.

Number of yards for COM fabric:

Code	Total	Seat	Frame
BCB26	3	,75	2,25

Note: It is recommend that you include a layout with all orders and that you choose a solid fabric color for the seat portion.

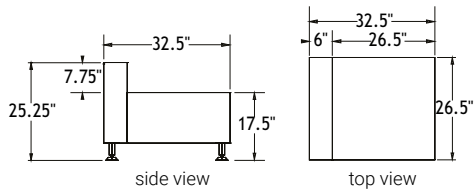

Prices

Code	GRA	GR1	COM GR2	GR3	GR4	GR5	GR6	GR7	GR8	GR9	GR10	GR11	GR12	Cuir Leather
BCB26	1252	1302	1368	1434	1517	1599	1682	1764	1847	1929	2012	2177	2342	2204

How to Order

Fabric
See the Logiflex Graded-in List

SS	BCB26	PQS			
series	code	top stitching	supplier	pattern	color

Example SS BCB26 PQS ENNIS LOFT AQUA

Modular Seating

Infiniti - Square Bench with Padded Arm and Laminate Panel

BCBM26

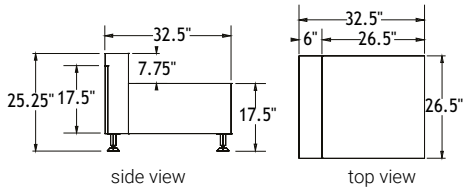
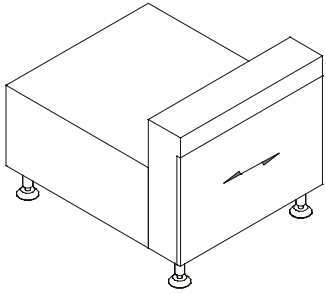

Manufacturing Standards

- 4 brushed chrome metal legs;
- Single top stitching;
- Elastic straps on seat;
- Firm density foam on seat and frame;
- 1/2" thick polyester on the sides of the frame;
- 5/8" thick laminate panel back, 17-1/2"H x 26-1/2"L (choice of Logiflex wood finish laminate color);
- Seat and frame made out of recycled materials.

Combination of Colors

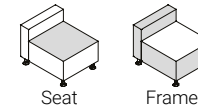

Number of yards for COM fabric:

Code	Total	Seat	Frame
BCBM26	2.75	.75	2

Note: It is recommend that you include a layout with all orders and that you choose a solid fabric color for the seat portion.



Prices

BCBM26

Code	GRA	GR1	COM GR2	GR3	GR4	GR5	GR6	GR7	GR8	GR9	GR10	GR11	GR12	Cuir Leather
BCBM26	1434	1479	1540	1600	1676	1751	1827	1903	1978	2054	2129	2281	2432	2306

BCBM26 - High Gloss Finish

Code	GRA	GR1	COM GR2	GR3	GR4	GR5	GR6	GR7	GR8	GR9	GR10	GR11	GR12	Cuir Leather
BCBM26	1580	1625	1686	1746	1822	1897	1973	2049	2124	2200	2275	2427	2578	2452

How to Order

Finishes
See the Logiflex Color Guide

Fabric
See the Logiflex Graded-in List

SS	BCBM26	PQS				
series	code	top stitching	supplier	pattern	color	laminat panel

Example	SS	BCBM26	PQS	ENNIS	LOFT	AQUA	GIA
----------------	----	--------	-----	-------	------	------	-----

Modular Seating

Infiniti - Square Bench with Backrest

BCD26

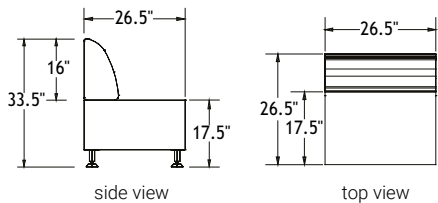
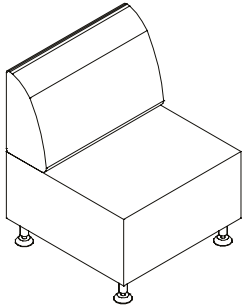

Combination of Colors

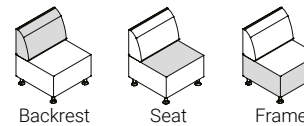

Manufacturing Standards

- 4 brushed chrome metal legs;
- Single top stitching;
- Elastic straps on seat and backrest;
- Firm density foam on seat and backrest;
- 1/2" thick polyester on the sides of the frame;
- Seat and backrest frames made out of recycled materials.

Number of yards for COM fabric:

Code	Total	Backrest	Seat	Frame
BCD26	3.5	1.25	1	1.5

Note: It is recommend that you include a layout with all orders and that you choose a solid fabric color for the seat portion.



Prices

Code	GRA	GR1	COM	GR2	GR3	GR4	GR5	GR6	GR7	GR8	GR9	GR10	GR11	GR12	Cuir Leather
BCD26	1333	1391	1468	1545	1641	1738	1834	1930	2026	2123	2219	2411	2604	2443	

How to Order

Fabric
See the Logiflex Graded-in List

SS	BCD26	PQS			
series	code	top stitching	supplier	pattern	color

Example SS BCD26 PQS ENNIS LOFT AQUA

Modular Seating

Infiniti - Arched Bench with Inner Backrest

BADI26

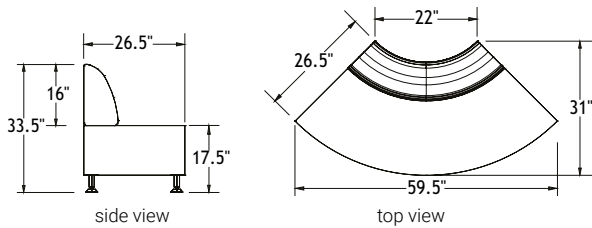
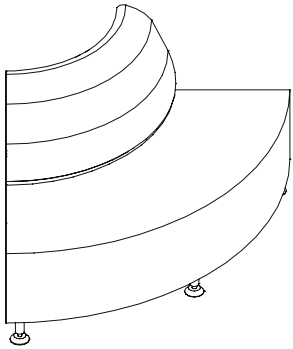

Manufacturing Standards

- 5 brushed chrome metal legs;
- Single top stitching;
- Elastic straps on seat and backrest;
- Firm density foam on seat and backrest;
- 1/2" thick polyester on the sides of the frame;
- Seat and backrest frames made out of recycled materials.

Combination of Colors

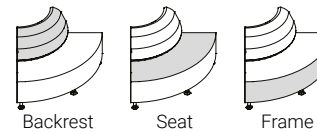

Number of yards for COM fabric:

Code	Total	Backrest	Seat	Frame
BADI26	4.25	1.25	1.75	1.75

Note: It is recommend that you include a layout with all orders and that you choose a solid fabric color for the seat portion.

Prices

Code	GRA	GR1	COM GR2	GR3	GR4	GR5	GR6	GR7	GR8	GR9	GR10	GR11	GR12	Cuir Leather
BADI26	2240	2310	2404	2497	2614	2731	2848	2965	3081	3198	3315	3549	3783	3588

How to Order

Fabric
See the Logiflex Graded-in List

SS	BADI26	PQS			
series	code	top stitching	supplier	pattern	color

Example

SS	BADI26	PQS	ENNIS	LOFT	AQUA
----	--------	-----	-------	------	------

Modular Seating

Infiniti - Arched Bench with Outer Backrest

BADE26

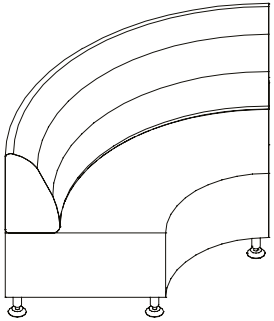

Combination of Colors

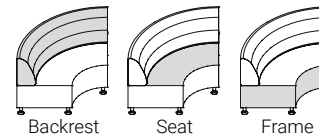

Manufacturing Standards

- 5 brushed chrome metal legs;
- Single top stitching;
- Elastic straps on seat and backrest;
- Firm density foam on seat and backrest;
- 1/2" thick polyester on the sides of the frame;
- Seat and backrest frames made out of recycled materials.

Number of yards for COM fabric:

Code	Total	Backrest	Seat	Frame
BADE26	5.5	2.5	1.75	1.75

Note: It is recommend that you include a layout with all orders and that you choose a solid fabric color for the seat portion.

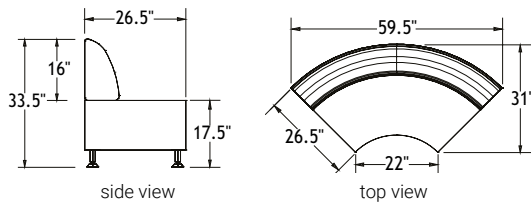

Prices																
Code	GRA	GR1	COM			GR3	GR4	GR5	GR6	GR7	GR8	GR9	GR10	GR11	GR12	Cuir Leather
BADE26	2315	2406	2527	2648	2799	2951	3102	3253	3404	3556	3707	4009	4312	4060		

How to Order

Fabric
See the Logiflex Graded-in List

SS	BADE26	PQS			
series	code	top stitching	supplier	pattern	color

Example SS BADE26 PQS ENNIS LOFT AQUA

Modular Seating

Infiniti - Corner Bench with Backrest

BCCD26

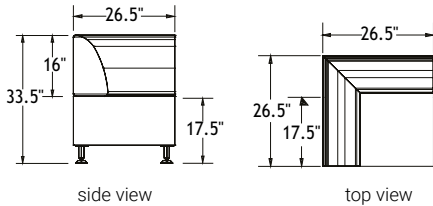
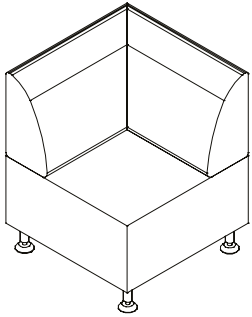

Combination of Colors

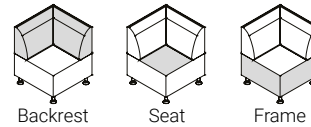

Manufacturing Standards

- 4 brushed chrome metal legs;
- Single top stitching;
- Elastic straps on seat and backrest;
- Firm density foam on seat and backrest;
- 1/2" thick polyester on the sides of the frame;
- Seat and backrest frames made out of recycled materials.

Number of yards for COM fabric:

Code	Total	Backrest	Seat	Frame
BCCD26	5	2.5	.75	1.75

Note: It is recommend that you include a layout with all orders and that you choose a solid fabric color for the seat portion.



Prices

Code	GRA	GR1	COM GR2	GR3	GR4	GR5	GR6	GR7	GR8	GR9	GR10	GR11	GR12	Cuir Leather
BCCD26	1459	1542	1652	1762	1900	2037	2175	2312	2450	2587	2725	3000	3275	3045

How to Order

Fabric
See the Logiflex Graded-in List

SS	BCCD26	PQS			
series	code	top stitching	supplier	pattern	color

Example **SS** **BCCD26** **PQS** **ENNIS** **LOFT** **AQUA**

Modular Seating

Infiniti - Rectangular Bench

BC36

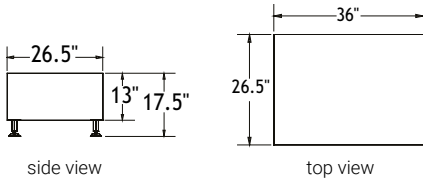
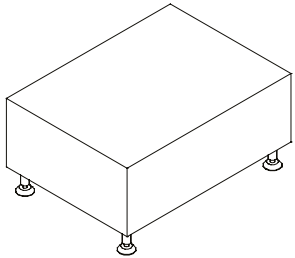

Combination of Colors

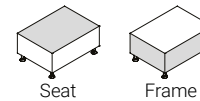

Manufacturing Standards

- 4 brushed chrome metal legs;
- Single top stitching;
- Elastic straps on seat;
- Firm density foam on seat;
- 1/2" thick polyester on the sides of the frame;
- Frame made out of plywood and hardwood..

Number of yards for COM fabric:

Code	Total	Seat	Frame
BC36	2.5	.75	1.75

Note: It is recommend that you include a layout with all orders and that you choose a solid fabric color for the seat portion.

Prices

Code	GRA	GR1	COM GR2	GR3	GR4	GR5	GR6	GR7	GR8	GR9	GR10	GR11	GR12	Cuir Leather
BC36	952	993	1048	1103	1172	1241	1309	1378	1447	1516	1584	1722	1859	1745

How to Order

Fabric
See the Logiflex Graded-in List

SS	BC36	PQS			
series	code	top stitching	supplier	pattern	color

Example SS BC36 PQS ENNIS LOFT AQUA

Modular Seating

Infiniti - Rectangular Bench with Backrest

BCD36

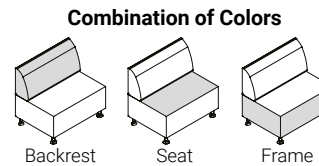
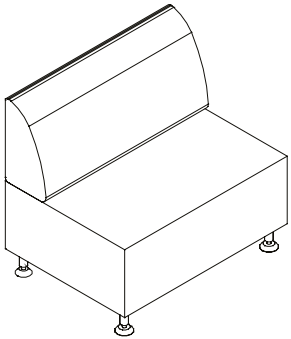

Manufacturing Standards

- 4 brushed chrome metal legs;
- Single top stitching;
- Elastic straps on seat and backrest;
- Firm density foam on seat and backrest;
- 1/2" thick polyester on the sides of the frame;
- Seat and backrest frames made out of recycled materials.

Number of yards for COM fabric:

Code	Total	Backrest	Seat	Frame
BCD36	3.75	1.25	.75	1.75

Note: It is recommend that you include a layout with all orders and that you choose a solid fabric color for the seat portion.

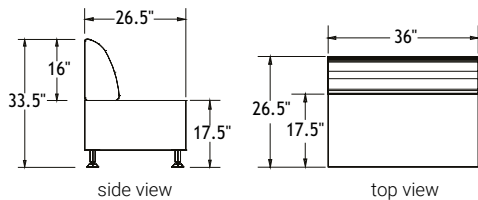

Prices

Code	GRA	GR1	COM			GR3	GR4	GR5	GR6	GR7	GR8	GR9	GR10	GR11	GR12	Cuir Leather
BCD36	1459	1521	1604	1686	1789	1892	1995	2099	2202	2305	2408	2614	2820	2649		

How to Order

Fabric
See the Logiflex Graded-in List

SS	BCD36	PQS			
series	code	top stitching	supplier	pattern	color

Example SS BCD36 PQS ENNIS LOFT AQUA

Modular Seating

Infiniti - Rectangular Bench

BC48

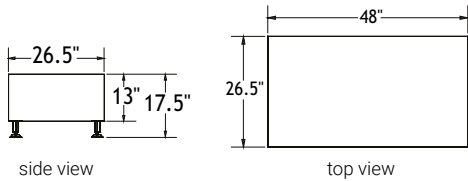
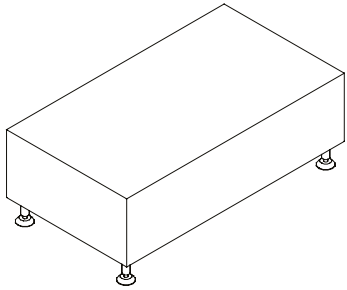

Manufacturing Standards

- 4 brushed chrome metal legs;
- Single top stitching;
- Elastic straps on seat;
- Firm density foam on seat;
- 1/2" thick polyester on the sides of the frame;
- Frame made out of plywood and hardwood..

Combination of Colors

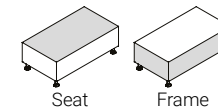

Number of yards for COM fabric:

Code	Total	Seat	Frame
BC48	2.75	.75	1.75

Note: It is recommend that you include a layout with all orders and that you choose a solid fabric color for the seat portion.



Prices

Code	GRA	GR1	COM GR2	GR3	GR4	GR5	GR6	GR7	GR8	GR9	GR10	GR11	GR12	Cuir Leather
BC48	1112	1157	1218	1278	1354	1429	1505	1581	1656	1732	1807	1959	2110	1984

How to Order

Fabric
See the Logiflex Graded-in List

SS	BC48	PQS			
series	code	top stitching	supplier	pattern	color

Example

SS	BC48	PQS	ENNIS	LOFT	AQUA
----	------	-----	-------	------	------

Modular Seating

Infiniti - Rectangular Bench with Backrest

BCD48

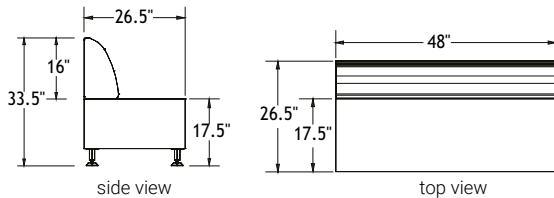
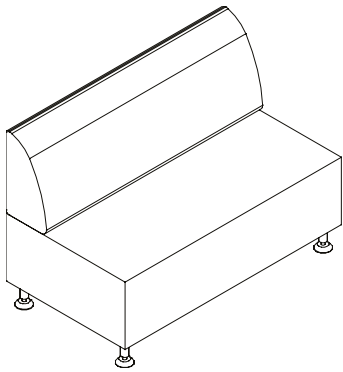

Combination of Colors

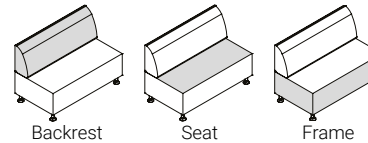

Manufacturing Standards

- 4 brushed chrome metal legs;
- Single top stitching;
- Elastic straps on seat and backrest;
- Firm density foam on seat and backrest;
- 1/2" thick polyester on the sides of the frame;
- Seat and backrest frames made out of recycled materials.

Number of yards for COM fabric:

Code	Total	Backrest	Seat	Frame
BCD48	4.5	2	.75	1.75

Note: It is recommend that you include a layout with all orders and that you choose a solid fabric color for the seat portion.

Prices

Code	GRA	GR1	COM	GR2	GR3	GR4	GR5	GR6	GR7	GR8	GR9	GR10	GR11	GR12	Cuir Leather
BCD48	1690	1764	1863	1962	2086	2210	2333	2457	2581	2705	2828	3076	3323	3117	

How to Order

Fabric
See the Logiflex Graded-in List

SS	BCD48	PQS			
series	code	top stitching	supplier	pattern	color

Example SS BCD48 PQS ENNIS LOFT AQUA

Modular Seating

Infiniti - Rectangular Bench with 30" Backrest on Left

BCDC48L

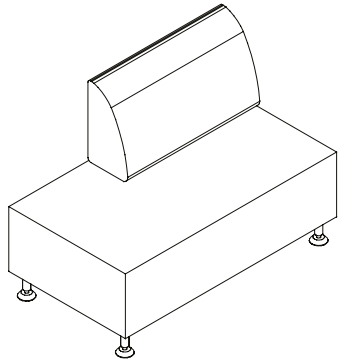

Combination of Colors

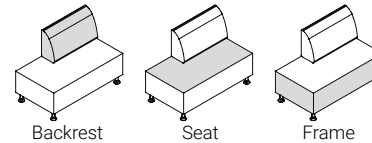

Manufacturing Standards

- 4 brushed chrome metal legs;
- Single top stitching;
- Elastic straps on seat and backrest;
- Firm density foam on seat and backrest;
- 1/2" thick polyester on the sides of the frame;
- Seat and backrest frames made out of recycled materials.

Number of yards for COM fabric:

Code	Total	Backrest	Seat	Frame
BCDC48L	4.5	2	.75	1.75

Note: It is recommend that you include a layout with all orders and that you choose a solid fabric color for the seat portion.

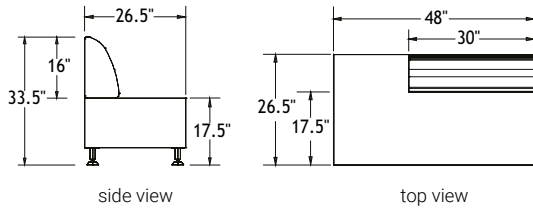

Prices															
Code	GRA	GR1	COM	GR2	GR3	GR4	GR5	GR6	GR7	GR8	GR9	GR10	GR11	GR12	Cuir Leather
BCDC48L	1648	1722	1821	1920	2044	2168	2291	2415	2539	2663	2786	3034	3281	3075	

How to Order

SS	BCDC48L	PQS	Fabric <i>See the Logiflex Graded-in List</i>			
series	code	top stitching	supplier	pattern	color	
Example	SS	BCDC48L	PQS	ENNIS	LOFT	AQUA

Modular Seating

Infiniti - Rectangular Bench with 30" Backrest on Right

BCDC48R

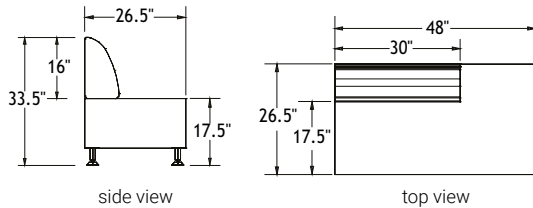
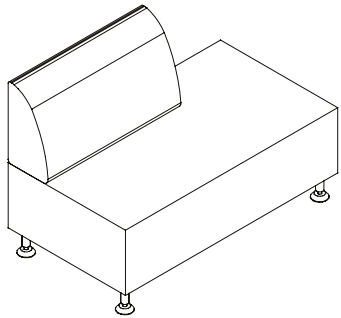

Manufacturing Standards

- 4 brushed chrome metal legs;
- Single top stitching;
- Elastic straps on seat and backrest;
- Firm density foam on seat and backrest;
- 1/2" thick polyester on the sides of the frame;
- Seat and backrest frames made out of recycled materials.

Combination of Colors

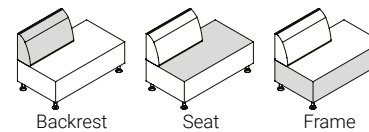

Number of yards for COM fabric:

Code	Total	Backrest	Seat	Frame
BCDC48R	4.5	2	.75	1.75

Note: It is recommend that you include a layout with all orders and that you choose a solid fabric color for the seat portion.



Prices

Code	GRA	GR1	COM GR2	GR3	GR4	GR5	GR6	GR7	GR8	GR9	GR10	GR11	GR12	Cuir Leather
BCDC48R	1648	1722	1821	1920	2044	2168	2291	2415	2539	2663	2786	3034	3281	3075

How to Order

Fabric
[See the Logiflex Graded-in List](#)

SS	BCDC48R	PQS			
series	code	top stitching	supplier	pattern	color

Example SS BCDC48R PQS ENNIS LOFT AQUA

Modular Seating

Clara - Circular Bench

CLA

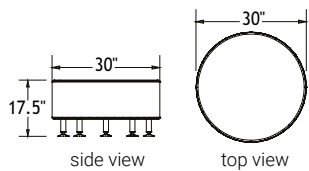
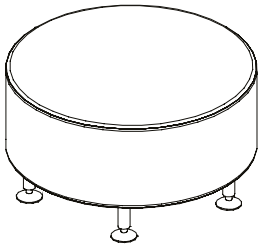

Combination of Colors

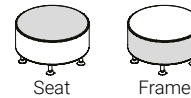

Manufacturing Standards

- 5 brushed chrome metal legs;
- Single top stitching;
- Firm density foam on seat;
- 1/2" thick polyester on the sides of the frame;
- Frame made out of recycled materials.

Number of yards for COM fabric:

Code	Total	Seat	Frame
CLA	1.75	1	1

Note: It is recommend that you include a layout with all orders and that you choose a solid fabric color for the seat portion.



Prices

Code	GRA	GR1	COM GR2	GR3	GR4	GR5	GR6	GR7	GR8	GR9	GR10	GR11	GR12	Cuir Leather
CLA	1178	1207	1246	1284	1332	1380	1428	1477	1525	1573	1621	1717	1813	1733

How to Order

Fabric
See the Logiflex Graded-in List

SS	CLA			
series	code	supplier	pattern	color

Example

SS	CLA	ENNIS	LOFT	AQUA
----	-----	-------	------	------

Modular Seating



Clara - Circular Single Nestle Bench

CLAS

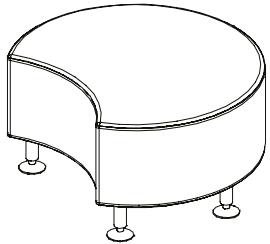

Manufacturing Standards

- 5 brushed chrome metal legs;
- Single top stitching;
- Firm density foam on seat;
- 1/2" thick polyester on the sides of the frame;
- Frame made out of recycled materials.

Combination of Colors

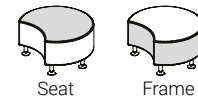

Number of yards for COM fabric:

Code	Total	Seat	Frame
CLAS	1.75	1	1

Note: It is recommend that you include a layout with all orders and that you choose a solid fabric color for the seat portion.

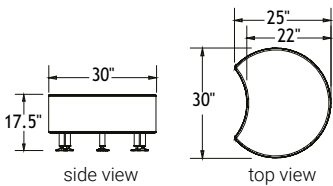

Prices														
Code	GRA	GR1	COM GR2	GR3	GR4	GR5	GR6	GR7	GR8	GR9	GR10	GR11	GR12	Cuir Leather
CLAS	1178	1207	1246	1284	1332	1380	1428	1477	1525	1573	1621	1717	1813	1733

How to Order

Fabric
See the Logiflex Graded-in List

SS	CLAS			
series	code	supplier	pattern	color

Example SS CLAS ENNIS LOFT AQUA

Modular Seating

Clara - Circular Double Nestle Bench

CLAD

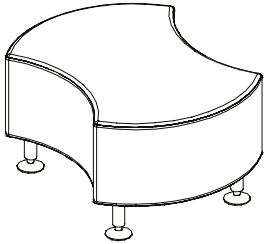

Manufacturing Standards

- 5 brushed chrome metal legs;
- Single top stitching;
- Firm density foam on seat;
- 1/2" thick polyester on the sides of the frame;
- Frame made out of recycled materials.

Combination of Colors

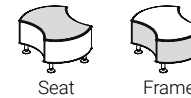

Number of yards for COM fabric:

Code	Total	Seat	Frame
CLAD	1.75	1	1

Note: It is recommend that you include a layout with all orders and that you choose a solid fabric color for the seat portion.

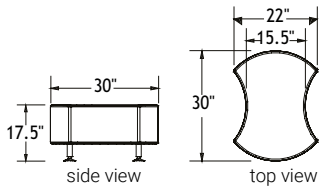

Prices

Code	GRA	GR1	COM GR2	GR3	GR4	GR5	GR6	GR7	GR8	GR9	GR10	GR11	GR12	Cuir Leather
CLAD	1178	1207	1246	1284	1332	1380	1428	1477	1525	1573	1621	1717	1813	1733

How to Order

Fabric
See the Logiflex Graded-in List

SS	CLAD			
series	code	supplier	pattern	color

Example **SS** **CLAD** **ENNIS** **LOFT** **AQUA**

Modular Seating

Clara - Circular Bench with Backrest

CLAB

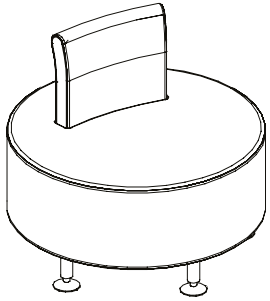

Combination of Colors

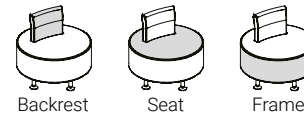

Manufacturing Standards

- 5 brushed chrome metal legs;
- Single top stitching;
- Elastic straps on backrest;
- Firm density foam on seat;
- 1/2" thick polyester on the sides of the frame;
- Frame made out of recycled materials.

Number of yards for COM fabric:

Code	Total	Backrest	Seat	Frame
CLAB	2	1	1	1

Note: It is recommend that you include a layout with all orders and that you choose a solid fabric color for the seat portion.

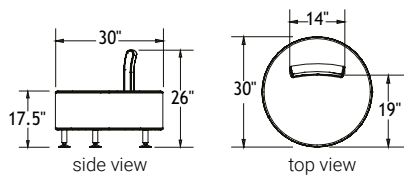

Prices

Code	GRA	GR1	COM	GR2	GR3	GR4	GR5	GR6	GR7	GR8	GR9	GR10	GR11	GR12	Cuir Leather
CLAB	2035	2068	2112	2156	2211	2266	2321	2376	2431	2486	2541	2651	2761	2669	

How to Order

Fabric
See the Logiflex Graded-in List

SS	CLAB			
series	code	supplier	pattern	color

Example SS CLAB ENNIS LOFT AQUA

Modular Seating

Leo - Circular Bench

LEO18

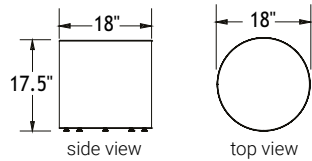
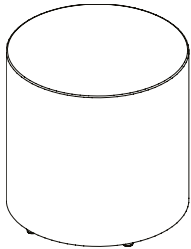

Manufacturing Standards

- Single top stitching;
- Firm density foam on seat;
- 1/2" thick polyester on the sides of the frame;
- Frame made out of recycled materials;
- On white nylon levelers;
- Total weight: 12.5 lbs.

Nylon Band: The height of the nylon band is 3-1/2" and is only offered in Momentum - Parable Shadow fabric.

Loop Handle: The interior fabric of the loop is in Momentum - Parable Shadow fabric.

Number of yards for COM fabric:

Code	Total	Seat	Frame
LEO18	1.25	.75	1.25

Note: It is recommend that you include a layout with all orders.

Combination of Colors

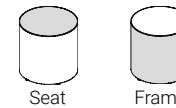

Options

Nylon Band

NYL
\$67

Loop Handle

LOOP
\$92

Prices

Code	GRA	GR1	COM GR2	GR3	GR4	GR5	GR6	GR7	GR8	GR9	GR10	GR11	GR12	Cuir Leather
LEO18	580	601	629	656	690	725	759	794	828	862	897	965	1034	977

How to Order

SS	LEO18	NYL	LOOP	Fabric <i>See the Logiflex Graded-in List</i>		
series	code	nylon band	loop handle	supplier	pattern	color
Example SS	LEO18	NYL	LOOP	ENNIS	LOFT	AQUA

Modular Seating

Leo - Circular Bench

LEO30

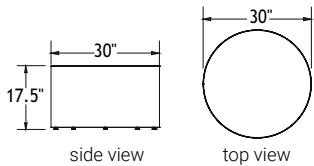
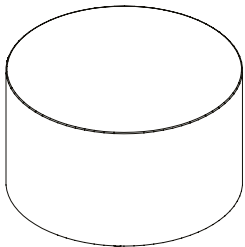

Manufacturing Standards

- Single top stitching;
- Firm density foam on seat;
- 1/2" thick polyester on the sides of the frame;
- Frame made out of recycled materials;
- On white nylon levelers.

Nylon Band: The height of the nylon band is 3-1/2" and is only offered in Momentum - Parable Shadow fabric.

Number of yards for COM fabric:

Code	Total	Seat	Frame
LEO30	2.25	1	1.25

Note: It is recommend that you include a layout with all orders.

Combination of Colors

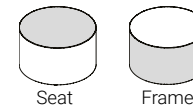

Options

Nylon Band

NYL
\$117

Prices

Code	GRA	GR1	COM GR2	GR3	GR4	GR5	GR6	GR7	GR8	GR9	GR10	GR11	GR12	Cuir Leather
LEO30	1036	1073	1123	1172	1234	1314	1358	1420	1481	1543	1605	1729	1853	1750

How to Order

SS	LEO30	NYL	Fabric <i>See the Logiflex Graded-in List</i>		
series	code	nylon band	supplier	pattern	color
Example SS	LEO30	NYL	ENNIS	LOFT	AQUA

Modular Seating

Leo - Circular Bench with Laminate Top

LEOT

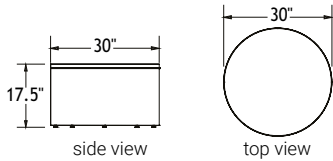
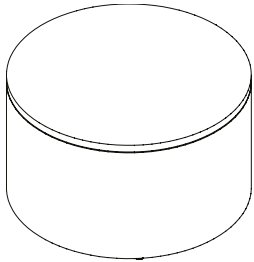

Combination of Colors

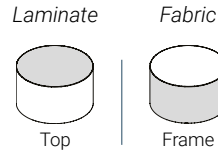

Manufacturing Standards

- 1" laminate top;
- 1/2" thick polyester on the sides of the frame;
- Frame made out of recycled materials;
- On white nylon levelers.

Nylon Band: The height of the nylon band is 3-1/2" and is only offered in Momentum - Parable Shadow fabric.

Number of yards for COM fabric:

Code	Total	Frame
LEOT	1.25	1.25

Note: It is recommend that you include a layout with all orders.

Options

Nylon Band

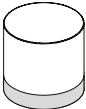

NYL
\$117

Marker Board



MB
\$222

Prices

Code	GRA	GR1	COM GR2	GR3	GR4	GR5	GR6	GR7	GR8	GR9	GR10	GR11	GR12	Cuir Leather
LEOT	1169	1190	1218	1245	1279	1314	1348	1383	1417	1451	1486	1554	1623	1566

How to Order

SS	LEOT	NYL	MB	Fabric <i>See the Logiflex Graded-in List</i>				Finishes <i>See the Logiflex Color Guide</i>
series	code	nylon band	marker board	supplier	pattern	color	top	
Example SS	LEOT	NYL	MB	ENNIS	LOFT	AQUA	GIA	

Modular Seating

Leo - Square Bench

LEOC18

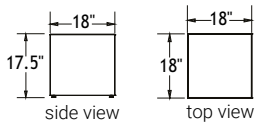
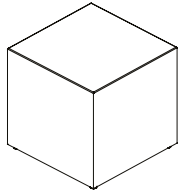

Combination of Colors

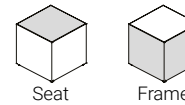

Manufacturing Standards

- Single top stitching;
- Firm density foam on seat;
- 1/2" thick polyester on the sides of the frame;
- Frame made out of recycled materials;
- On white nylon levelers;
- Total weight: 14.5 lbs.

Nylon Band: The height of the nylon band is 3-1/2" and is only offered in Momentum - Parable Shadow fabric.

Loop Handle: The interior fabric of the loop is in Momentum - Parable Shadow fabric.

Number of yards for COM fabric:

Code	Total	Seat	Frame
LEOC18	2	.75	1.25

Note: It is recommend that you include a layout with all orders.

Options

Nylon Band

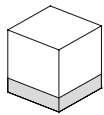

NYL
\$85

Loop Handle

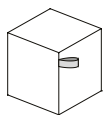

LOOP
\$92

Prices

Code	GRA	GR1	COM GR2	GR3	GR4	GR5	GR6	GR7	GR8	GR9	GR10	GR11	GR12	Cuir Leather
LEOC18	597	630	674	718	773	1395	883	938	993	1048	1103	1213	1323	1231

How to Order

SS	LEOC18	NYL	LOOP	Fabric <i>See the Logiflex Graded-in List</i>			
series	code	nylon band	loop handle	supplier	pattern	color	
Example	SS	LEOC18	NYL	LOOP	ENNIS	LOFT	AQUA

Modular Seating

Leo - Square Bench

LEOC30

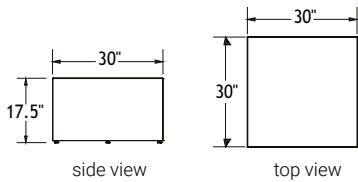
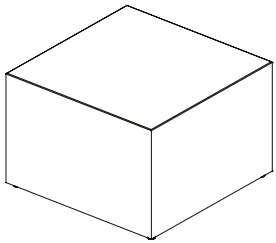

Manufacturing Standards

- Single top stitching;
- Firm density foam on seat;
- 1/2" thick polyester on the sides of the frame;
- Frame made out of recycled materials;
- On white nylon levelers.

Nylon Band: The height of the nylon band is 3-1/2" and is only offered in Momentum - Parable Shadow fabric.

Number of yards for COM fabric:

Code	Total	Seat	Frame
LEOC30	3.25	1	2.25

Note: It is recommend that you include a layout with all orders.

Combination of Colors

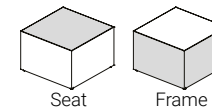

Options

Nylon Band

NYL
\$198

Prices

Code	GRA	GR1	COM GR2	GR3	GR4	GR5	GR6	GR7	GR8	GR9	GR10	GR11	GR12	Cuir Leather
LEOC30	1019	1073	1145	1216	1305	1395	1484	1574	1663	1752	1842	2020	2199	2050

How to Order

SS	LEOC30	NYL	Fabric <i>See the Logiflex Graded-in List</i>			
series	code	nylon band	supplier	pattern	color	
Example	SS	LEOC30	NYL	ENNIS	LOFT	AQUA

Modular Seating

Leo - Square Bench with Laminate Top

LEOCT

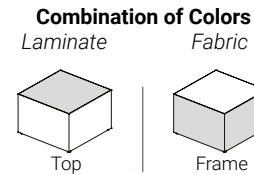
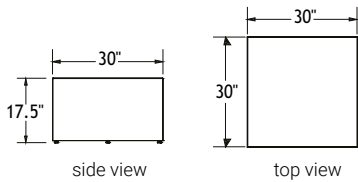
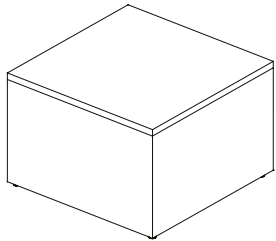

Manufacturing Standards

- 1" laminate top;
- 1/2" thick polyester on the sides of the frame;
- Frame made out of recycled materials;
- On white nylon levelers.

Nylon Band: The height of the nylon band is 3-1/2" and is only offered in Momentum - Parable Shadow fabric.

Number of yards for COM fabric:

Code	Total	Frame
LEOCT	2,25	2,25

Note: It is recommend that you include a layout with all orders.

Options

Nylon Band

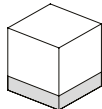

NYL
\$198

Marker Board



MB
\$222

Prices

Code	GRA	GR1	COM GR2	GR3	GR4	GR5	GR6	GR7	GR8	GR9	GR10	GR11	GR12	Cuir Leather
LEOCT	1153	1190	1240	1289	1351	1413	1475	1537	1598	1660	1722	1846	1970	1867

How to Order

SS	LEOCT	NYL	MB	Fabric <i>See the Logiflex Graded-in List</i>				Finishes <i>See the Logiflex Color Guide</i>
series	code	nylon band	marker board	supplier	pattern	color	top	
Example	SS	LEOCT	NYL	MB	ENNIS	LOFT	AQUA	GIA

Soft Seating

Alpha - Single Armchair

1403

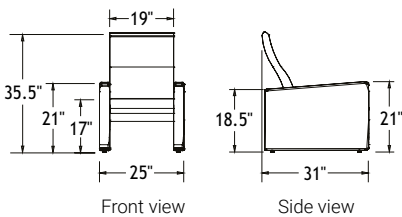
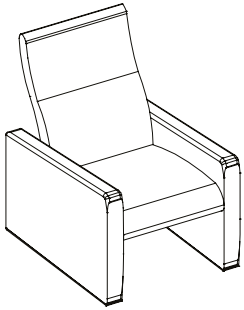

Combination of Colors

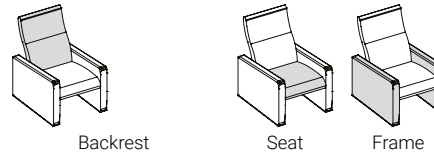

Manufacturing Standards

- 4 levelers, 7/8" diameter;
- Single top stitching;
- Medium-density foam on seat;
- 1" memory foam on backrest;
- Molded wood boards for seat and backrest;
- Rest of frame made out of recycled materials.

Number of yards for COM fabric:

Code	Total	Backrest	Seat	Frame
1403	4.25	1.75	1	1.5



Prices

Code	GRA	GR1	COM GR2	GR3	GR4	GR5	GR6	GR7	GR8	GR9	GR10	GR11	GR12	Cuir Leather
1403	1351	1425	1524	1623	1747	1871	1994	2118	2242	2366	2489	2737	2984	2778

How to Order

Fabric

[See the Logiflex Graded-in List](#)

SS	1403	N			
series	code	leveler	supplier	pattern	color

Example

SS	1403	N	ENNIS	LOFT	AQUA
-----------	-------------	----------	--------------	-------------	-------------

Soft Seating

Alpha - Double Armchair

1405

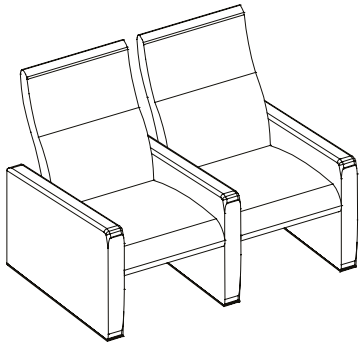

Combination of Colors

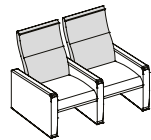

Backrest

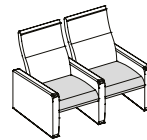

Seat

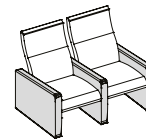

Frame

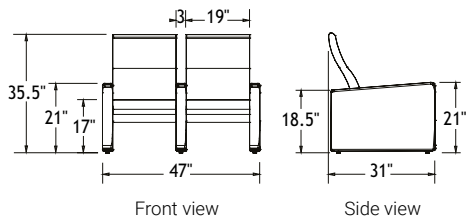

Manufacturing Standards

- 6 levelers, 7/8" diameter;
- Single top stitching;
- Medium-density foam on seat;
- 1" memory foam on backrest;
- Molded wood boards for seat and backrest;
- Rest of frame made out of recycled materials.

Number of yards for COM fabric:

Code	Total	Backrest	Seat	Frame
1405	5.5	1.75	1.5	2.25

Prices														
Code	GRA	GR1	COM GR2	GR3	GR4	GR5	GR6	GR7	GR8	GR9	GR10	GR11	GR12	Cuir Leather
1405	2249	2340	2461	2582	2733	2885	3036	3187	3338	3490	3641	3943	4246	3994

How to Order

Fabric

[See the Logiflex Graded-in List](#)

SS	1405	N			
series	code	leveler	supplier	pattern	color

Example	SS	1405	N	ENNIS	LOFT	AQUA
----------------	----	------	---	-------	------	------

Soft Seating

Alpha - Triple Armchair

1407

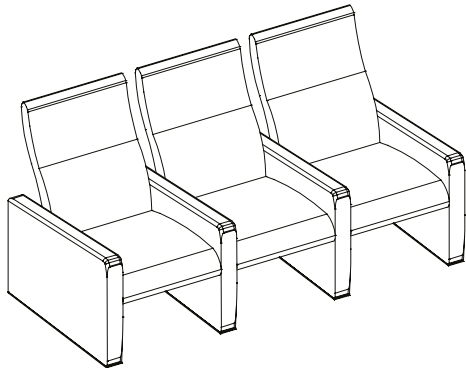

Combination of Colors

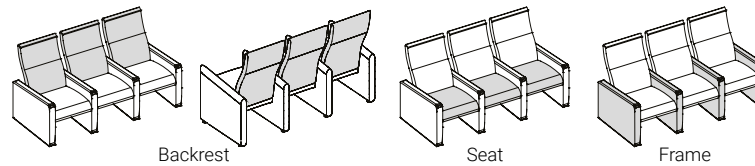

Manufacturing Standards

- 8 levelers, 7/8" diameter;
- Single top stitching;
- Medium-density foam on seat;
- 1" memory foam on backrest;
- Molded wood boards for seat and backrest;
- Rest of frame made out of recycled materials.

Number of yards for COM fabric:

Code	Total	Backrest	Seat	Frame
1407	8.75	3.5	2.25	3

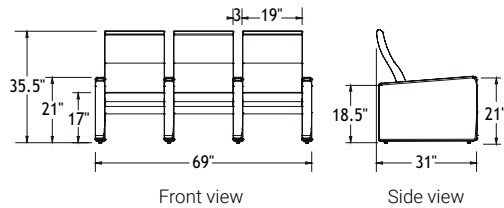

														Prices	
Code	GRA	GR1	COM		GR3	GR4	GR5	GR6	GR7	GR8	GR9	GR10	GR11	GR12	Cuir Leather
1407	2819	2963	3156	3348	3589	3829	4070	4311	4551	4792	5032	5514	5995	5594	

How to Order

Fabric
See the Logiflex Graded-in List

SS	1407	N			
series	code	leveler	supplier	pattern	color

Example	SS	1407	N	ENNIS	LOFT	AQUA
----------------	-----------	-------------	----------	--------------	-------------	-------------

Soft Seating

Bulexi - Armchair

5010

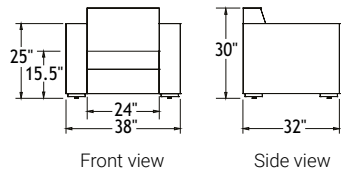
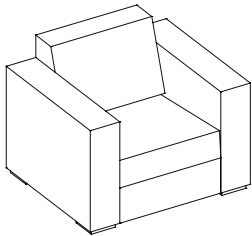

Manufacturing Standards

- Set of 4 wood legs BWL;
- Double top stitching;
- Elastic straps on backrest;
- 9 GA springs within the seat;
- Medium-density foam on the seat;
- Medium-density foam with 1" of memory foam for the backrest;
- All cushions are covered with stitched Dacron;
- Backrest cushions are fixed to the structure by a zipper;
- Made out of recycled materials, seating and backrest structure made of hardwood and plywood.

Option: Set of 4 chrome metal legs, BCHR.

Wood finishes: Available colors: White Wash WW, Golden Wheat GW, Sand SD, Apricot AT, Pecan PN, Brandy BR, Chestnut CT, Coffee CF, Espresso ES, Bordeaux BO, Black Wash BW and Bark BK.

Number of yards for COM fabric:

Code	Total	Backrest	Seat	Frame
5010	5.5	1.25	2	3.5

Combination of Colors

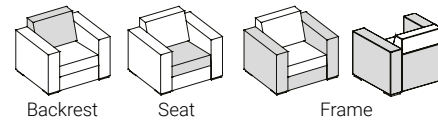

Prices														
Code	GRA	GR1	COM									Cuir	Leather	
			GR2	GR3	GR4	GR5	GR6	GR7	GR8	GR9	GR10	GR11	GR12	
5010 BWL	2288	2379	2500	2621	2772	2924	3075	3226	3377	3529	3680	3982	4285	4033
5010 BCHR	2676	2767	2888	3009	3160	3312	3463	3614	3765	3917	4068	4370	4673	4421

How to Order

		BCHR BWL (std)	Finishes <i>See the Logiflex Color Guide</i>	Fabric <i>See the Logiflex Graded-in List</i>			
SS	5010						
series	code	legs	leg color	supplier	pattern	color	
Example	SS	5010	BWL	BK	ENNIS	LOFT	AQUA

Soft Seating

Bulexi - Loveseat

5020

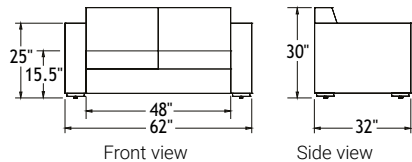
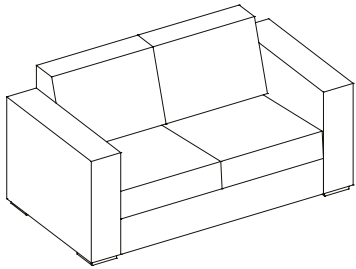

Combination of Colors

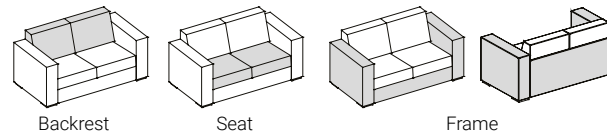

Manufacturing Standards

- Set of 4 wood legs BWL;
- Double top stitching;
- Elastic straps on backrest;
- 9 GA springs within the seat;
- Medium-density foam on the seat;
- Medium-density foam with 1" of memory foam for the backrest;
- All cushions are covered with stitched Dacron;
- Backrest cushions are fixed to the structure by a zipper;
- Made out of recycled materials, seating and backrest structure made of hardwood and plywood.

Option: Set of 4 chrome metal legs, BCHR.

Wood finishes: Available colors: White Wash WW, Golden Wheat GW, Sand SD, Apricot AT, Pecan PN, Brandy BR, Chestnut CT, Coffee CF, Espresso ES, Bordeaux BO, Black Wash BW and Bark BK.

Number of yards for COM fabric:

Code	Total	Backrest	Seat	Frame
5020	8	2.5	4	4

Prices														
Code	GRA	GR1	COM									GR12	Cuir Leather	
5020 BWL	3207	3339	3515	3691	3911	4131	4351	4571	4791	5011	5231	5671	6111	5744
5020 BCHR	3973	4105	4281	4457	4677	4897	5117	5337	5557	5777	5997	6437	6877	6510

How to Order

SS	5020	BCHR BWL (std)	Finishes See the Logiflex Color Guide	Fabric See the Logiflex Graded-in List		
series	code	legs	leg color	supplier	pattern	color
Example SS	5020	BWL	BK	ENNIS	LOFT	AQUA

Soft Seating

Bulexi - Sofa

5030

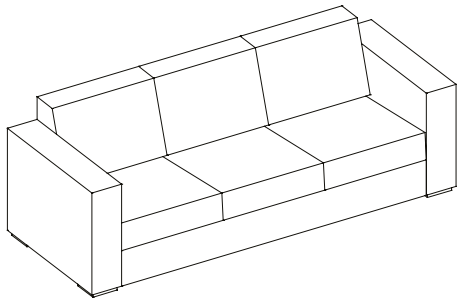

Combination of Colors

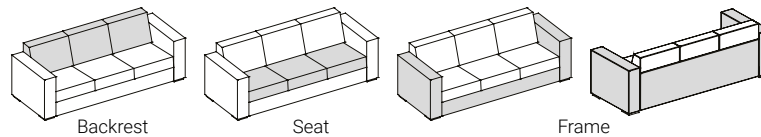

Manufacturing Standards

- Set of 4 wood legs BWL;
- Double top stitching;
- Elastic straps on backrest;
- 9 GA springs within the seat;
- Medium-density foam on the seat;
- Medium-density foam with 1" of memory foam for the backrest;
- All cushions are covered with stitched Dacron;
- Backrest cushions are fixed to the structure by a zipper;
- Made out of recycled materials, seating and backrest structure made of hardwood and plywood.

Option: Set of 4 chrome metal legs, BCHR.

Wood finishes: Available colors: White Wash WW, Golden Wheat GW, Sand SD, Apricot AT, Pecan PN, Brandy BR, Chestnut CT, Coffee CF, Espresso ES, Bordeaux BO, Black Wash BW and Bark BK.

Number of yards for COM fabric:

Code	Total	Backrest	Seat	Frame
5030	10.5	5	6	4.5

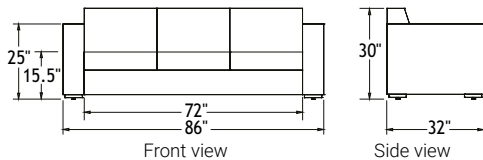

Prices														
Code	GRA	GR1	COM										Cuir Leather	
			GR2	GR3	GR4	GR5	GR6	GR7	GR8	GR9	GR10	GR11	GR12	
5030 BWL	4486	4659	4890	5121	5410	5699	5987	6276	6565	6854	7142	7720	8297	7816
5030 BCHR	5085	5258	5489	5720	6009	6298	6586	6875	7164	7453	7741	8319	8896	8415

How to Order

SS	5030	BCHR BWL (std)	Finishes See the Logiflex Color Guide	Fabric See the Logiflex Graded-in List			
series	code	legs	leg color	supplier	pattern	color	
Example	SS	5030	BWL	BK	ENNIS	LOFT	AQUA

Soft Seating

Dean - Armchair

DEA1

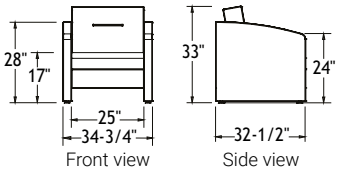
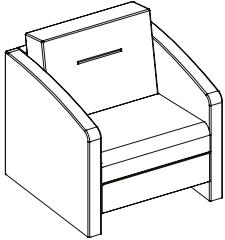

Combination of Colors

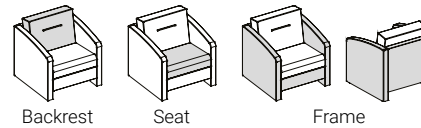

Manufacturing Standards

- Springs for the seat and backrest;
- Single top stitching;
- Medium-density foam;
- Frame made out of recycled and recyclable particles.

Option: Set of 4 metal oval legs in satin nickel finish, OVAMSN.

Number of yards for COM fabric:

Code	Total	Backrest	Seat	Frame
DEA1	5.75	1.25	1	3

Options

Legs

Set of 4 oval metal corner legs on leveler. Satin Nickel finish. 4"H



OVAMSN
\$0

Prices

Code	GRA	GR1	COM GR2	GR3	GR4	GR5	GR6	GR7	GR8	GR9	GR10	GR11	GR12	Cuir Leather
DEA1	1570	1665	1792	1918	2076	2234	2392	2551	2709	2867	3025	3341	3657	3394

How to Order

SS	DEA1	OVAMSN	Fabric <i>See the Logiflex Graded-in List</i>		
series	code	legs	supplier	pattern	color
Example SS	DEA1	OVAMSN	ENNIS	LOFT	AQUA

Soft Seating

Dean - Loveseat

DEA2

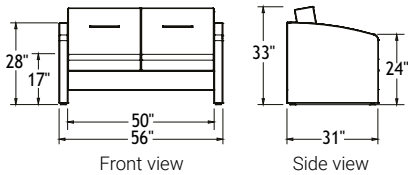
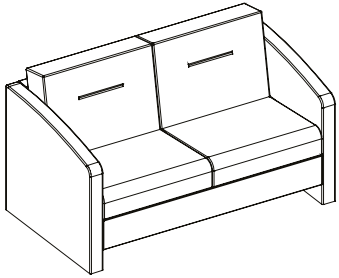

Combination of Colors

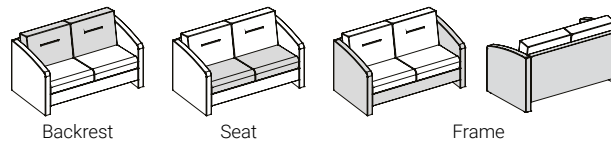

Manufacturing Standards

- Springs for the seat and backrest;
- Single top stitching;
- Medium-density foam;
- Frame made out of recycled and recyclable particles.

Option: Set of 4 metal oval legs in satin nickel finish, OVAMSN.

Number of yards for COM fabric:

Code	Total	Backrest	Seat	Frame
DEA2	7.75	2.5	1.75	3.75

Options

Legs

Set of 4 oval metal corner legs on leveler. Satin Nickel finish. 4"H



OVAMSN
\$0

Prices

Code	GRA	GR1	COM GR2	GR3	GR4	GR5	GR6	GR7	GR8	GR9	GR10	GR11	GR12	Cuir Leather
DEA2	2246	2374	2545	2715	2928	3141	3354	3568	3781	3994	4207	4633	5059	4704

How to Order

SS	DEA2	OVAMSN	Fabric <i>See the Logiflex Graded-in List</i>			
series	code	legs	supplier	pattern	color	
Example	SS	DEA2	OVAMSN	ENNIS	LOFT	AQUA

Soft Seating

Dean - Sofa

DEA3

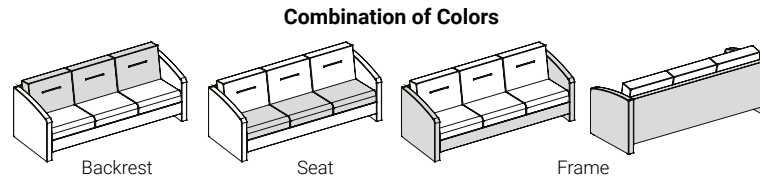
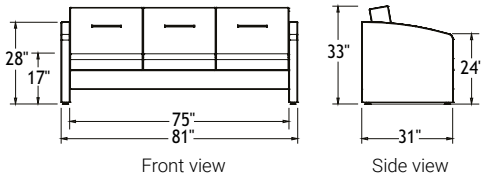
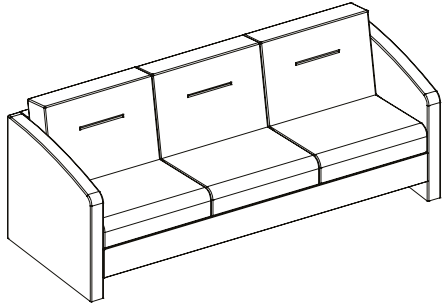

Combination of Colors

Manufacturing Standards

- Springs for the seat and backrest;
- Single top stitching;
- Medium-density foam;
- Frame made out of recycled and recyclable particles.

Option: Set of 4 metal oval legs in satin nickel finish, OVAMSN.

Number of yards for COM fabric:

Code	Total	Backrest	Seat	Frame
DEA3	10.5	3.5	2.75	4.25

Options

Legs

Set of 4 oval metal corner legs on leveler. Satin Nickel finish. 4"H



OVAMSN
\$0

Prices

Code	GRA	GR1	COM GR2	GR3	GR4	GR5	GR6	GR7	GR8	GR9	GR10	GR11	GR12	Cuir Leather
DEA3	3015	3188	3419	3650	3939	4228	4516	4805	5094	5383	5671	6249	6826	6345

How to Order

SS	DEA3	OVAMSN	Fabric <i>See the Logiflex Graded-in List</i>		
series	code	legs	supplier	pattern	color
Example SS	DEA3	OVAMSN	ENNIS	LOFT	AQUA

Soft Seating

Flint - Armchair

3010FBW

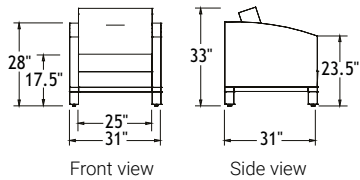
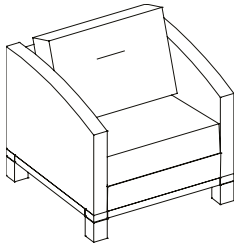

Manufacturing Standards

- Wooden base FBW with 4 legs;
- Single top stitching;
- 9 GA springs for the seat and 11 GA for the backrest;
- Medium-density foam on seat and backrest;
- Firm density foam on the top of the armrests;
- Frame made out of recycled materials and hardwood for seating base.

Wood finishes: Available colors: White Wash WW, Golden Wheat GW, Sand SD, Apricot AT, Pecan PN, Brandy BR, Chestnut CT, Coffee CF, Espresso ES, Bordeaux BO, Black Wash BW and Bark BK.

Number of yards for COM fabric:

Code	Total	Backrest	Seat	Frame
3010FBW	4	1.25	1	3

Combination of Colors

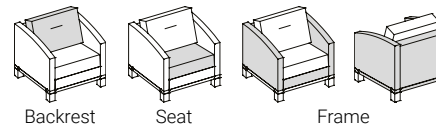

Options

Double Stitching

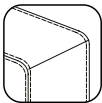

\$0

Prices

Code	GRA	GR1	COM	GR2	GR3	GR4	GR5	GR6	GR7	GR8	GR9	GR10	GR11	GR12	Cuir Leather
3010FBW	1742	1808	1896	1984	2094	2204	2314	2424	2534	2644	2754	2974	3194	3011	

How to Order

		+	Finishes <i>See the Logiflex Color Guide</i>	Fabric <i>See the Logiflex Graded-in List</i>			
SS	3010FBW	PQD PQS (std)					
series	code	top stitch	leg color	supplier	pattern	color	
Example	SS	3010FBW	PQS	BK	ENNIS	LOFT	AQUA

Soft Seating

Flint - Loveseat

3020FBW

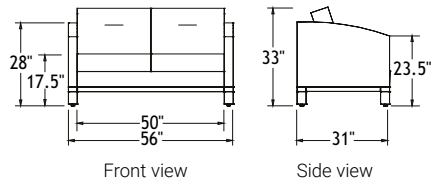
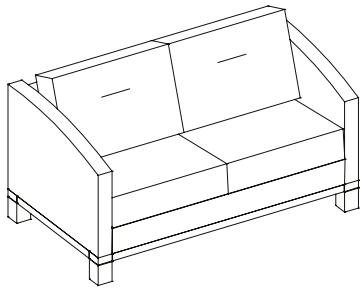

Combination of Colors

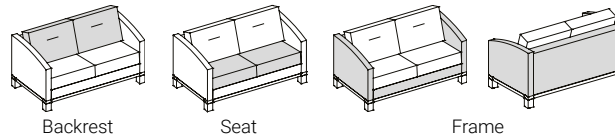

Manufacturing Standards

- Wooden base FBW with 4 legs;
- Single top stitching;
- 9 GA springs for the seat and 11 GA for the backrest;
- Medium-density foam on seat and backrest;
- Firm density foam on the top of the armrests;
- Frame made out of recycled materials and hardwood for seating base.

Wood finishes: Available colors: White Wash WW, Golden Wheat GW, Sand SD, Apricot AT, Pecan PN, Brandy BR, Chestnut CT, Coffee CF, Espresso ES, Bordeaux BO, Black Wash BW and Bark BK.

Number of yards for COM fabric:

Code	Total	Backrest	Seat	Frame
3020FBW	7.5	2.5	1.75	3.5

Options

Double Stitching

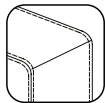

\$0

Prices

Code	GRA	GR1	COM GR2	GR3	GR4	GR5	GR6	GR7	GR8	GR9	GR10	GR11	GR12	Cuir Leather
3020FBW	2473	2597	2762	2927	3133	3340	3546	3752	3958	4165	4371	4783	5196	4852

How to Order

		+	Finishes <i>See the Logiflex Color Guide</i>	Fabric <i>See the Logiflex Graded-in List</i>			
SS	3020FBW	PQD PQS (std)					
series	code	top stitch	leg color	supplier	pattern	color	
Example	SS	3020FBW	PQS	BK	ENNIS	LOFT	AQUA

Soft Seating

Flint - Sofa

3030FBW

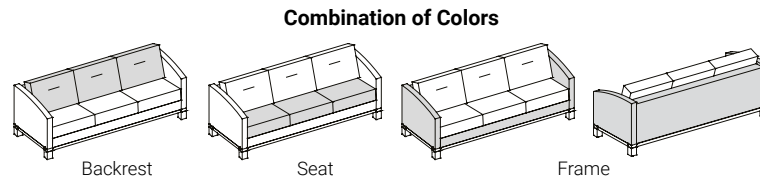
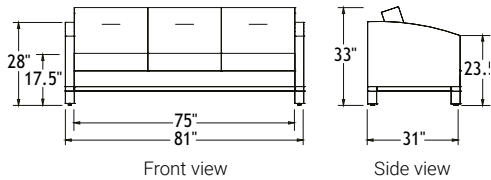
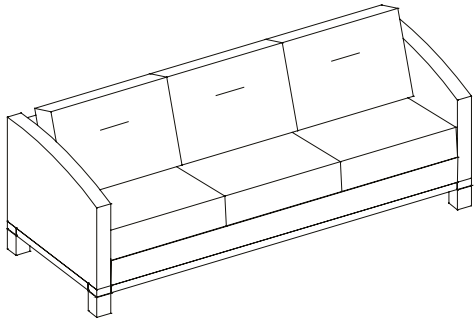

Combination of Colors

Manufacturing Standards

- Wooden base FBW with 4 legs;
- Single top stitching;
- 9 GA springs for the seat and 11 GA for the backrest;
- Medium-density foam on seat and backrest;
- Firm density foam on the top of the armrests;
- Frame made out of recycled materials and hardwood for seating base.

Wood finishes: Available colors: White Wash WW, Golden Wheat GW, Sand SD, Apricot AT, Pecan PN, Brandy BR, Chestnut CT, Coffee CF, Espresso ES, Bordeaux BO, Black Wash BW and Bark BK.

Number of yards for COM fabric:

Code	Total	Backrest	Seat	Frame
3030FBW	10.25	3.5	2.75	4.25

+ Options

Double Stitching

\$0

\$ Prices

Code	GRA	GR1	COM GR2	GR3	GR4	GR5	GR6	GR7	GR8	GR9	GR10	GR11	GR12	Cuir Leather
3030FBW	3238	3407	3633	3858	4140	4422	4704	4986	5267	5549	5831	6395	6959	6489

How to Order

SS	3030FBW	PQD PQS (std)	Finishes See the Logiflex Color Guide	Fabric See the Logiflex Graded-in List		
series	code	top stitch	leg color	supplier	pattern	color
Example SS	3030FBW	PQS	BK	ENNIS	LOFT	AQUA

Soft Seating

Magog - Armchair

MAG

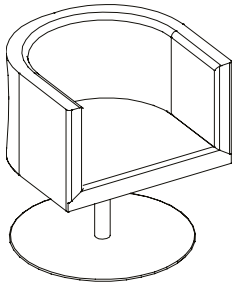

Manufacturing Standards

- 180° swivel armchair that returns to its initial position;
- Single top stitching;
- Medium-density foam;
- Circular base (24" diameter) with glides.

Combination of Colors

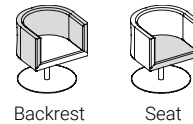

Number of yards for COM fabric:

Code	Total	Backrest	Seat
MAG	4.25	3.25	1

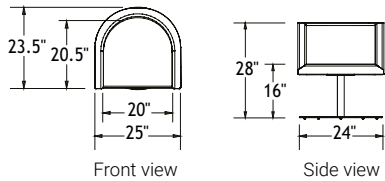

Prices														
Code	GRA	GR1	GR2	GR3	GR4	GR5	GR6	GR7	GR8	GR9	GR10	GR11	GR12	Cuir Leather
MAG SN	2230	2300	2394	2487	2604	2721	2838	2955	3071	3188	3305	3539	3773	3578
MAG BL	2230	2300	2394	2487	2604	2721	2838	2955	3071	3188	3305	3539	3773	3578
MAG CHR	2920	2990	3084	3177	3294	3411	3528	3645	3761	3878	3995	4229	4463	4268

How to Order

SS	MAG	BL SN CHR	Fabric <i>See the Logiflex Graded-in List</i>		
series	code	base	supplier	pattern	color
SS	MAG	CHR	ENNIS	LOFT	AQUA

Example

Soft Seating

Orford - Armchair

ORF

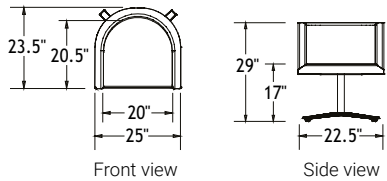
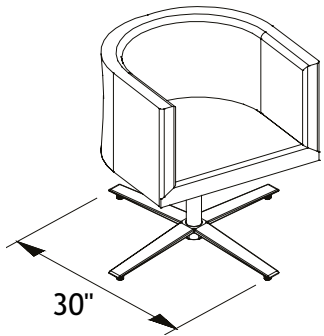

Manufacturing Standards

- 180° swivel armchair that returns to its initial position;
- Single top stitching;
- Medium-density foam;
- Aluminum base with glides;
- Footing dimension: 30" wide.

Combination of Colors

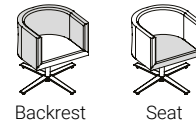

Number of yards for COM fabric:

Code	Total	Backrest	Seat
ORF	4.25	3.25	1

Prices

Code	GRA	GR1	COM GR2	GR3	GR4	GR5	GR6	GR7	GR8	GR9	GR10	GR11	GR12	Cuir Leather
ORF SN	2809	2879	2973	3066	3183	3300	3417	3534	3650	3767	3884	4118	4352	4157
ORF BL	2809	2879	2973	3066	3183	3300	3417	3534	3650	3767	3884	4118	4352	4157
ORF CHR	3240	3310	3404	3497	3614	3731	3848	3965	4081	4198	4315	4549	4783	4588

How to Order

SS	ORF	BL SN CHR	Fabric <i>See the Logiflex Graded-in List</i>		
series	code	base	supplier	pattern	color
SS	ORF	CHR	ENNIS	LOFT	AQUA

Example

Soft Seating

Stelli - Armchair

6750

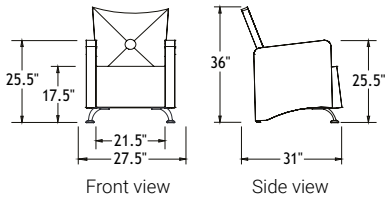
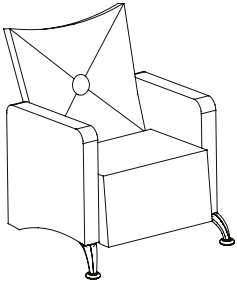

Combination of Colors

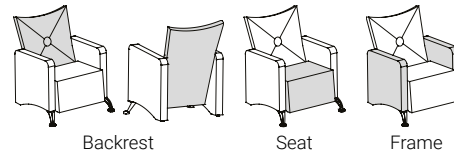

Manufacturing Standards

- 2 metal legs PM (brushed nickel finish) in front and 2 levelers in the back;
- Single top stitching;
- Elastic straps on seat and back;
- Medium-density foam on seat and backrest;
- Firm density foam on the top of the armrests;
- Standard button and "X" stitch in the backrest;
- Frame made out of recycled materials.

Wooden Legs option: 2 wooden legs, WL, 3" x 3" x 3-3/4" with levelers, choice of Logiflex wood finishes.

No Button: option to remove the button and the decorative "X" on the backrest.

Pivoting Shelf: 20" x 11-5/8" pivoting shelf of 3/4" hardwood.

Wood finishes: Available colors: White Wash WW, Golden Wheat GW, Sand SD, Apricot AT, Pecan PN, Brandy BR, Chestnut CT, Coffee CF, Espresso ES, Bordeaux BO, Black Wash BW and Bark BK.

Number of yards for COM fabric:

Code	Total	Backrest	Seat	Frame
6750	4,25	2,25	1,25	3,25

Options

2 Wooden Legs WL \$ 40 ea.	Double Stitching \$0	No Button SBX \$0	Pivoting Shelf Left SPL \$328	Right SPR \$328
--	------------------------------------	---	--	----------------------------------

Prices

Code	GRA	GR1	COM GR2	GR3	GR4	GR5	GR6	GR7	GR8	GR9	GR10	GR11	GR12	Cuir Leather
6750 PM	1664	1734	1828	1921	2038	2155	2272	2389	2505	2622	2739	2973	3207	3012
6750 WL	1754	1824	1918	2011	2128	2245	2362	2479	2595	2712	2829	3063	3297	3102

How to Order

SS	6750	WL PM (std)	PQS (std)	SBX	SPL SPR	Fabric <i>See the Logiflex Graded-in List</i>		
series	code	legs	top stitch	no button	pivoting shelf	supplier	pattern	color
Example SS	6750	PM	PQS			ENNIS	LOFT	AQUA

Soft Seating

Stelli - Loveseat

6753

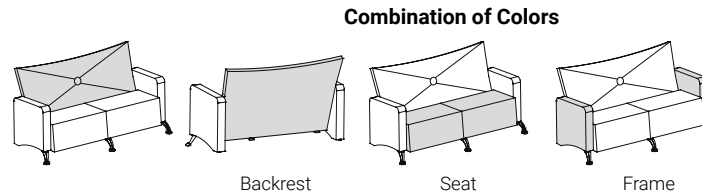
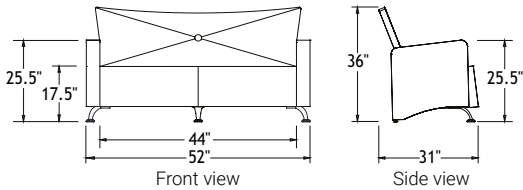
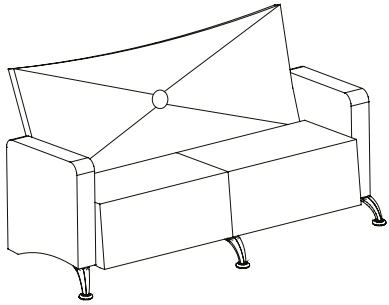

Manufacturing Standards

- 3 metal legs PM (brushed nickel finish) in front and 2 levelers in the back;
- Single top stitching;
- Elastic straps on seat and back;
- Medium-density foam on seat and backrest;
- Firm density foam on the top of the armrests;
- Standard button and "X" stitch in the backrest;
- Frame made out of recycled materials.

Wooden Legs option: 3 wooden legs, WL, 4" x 4" x 3-3/4" levelers, choice of Logiflex wood finishes.

No Button: option to remove the button and the decorative "X" on the backrest.

Pivoting Shelf: 20" x 11-5/8" pivoting shelf of 3/4" hardwood.

Wood finishes: Available colors: White Wash WW, Golden Wheat GW, Sand SD, Apricot AT, Pecan PN, Brandy BR, Chestnut CT, Coffee CF, Espresso ES, Bordeaux BO, Black Wash BW and Bark BK.

Number of yards for COM fabric:

Code	Total	Backrest	Seat	Frame
6753	6.75	4	1.75	3.5

Options

2 Wooden Legs	Double Stitching	No Button	Pivoting Shelf	
			Left	Right
WL \$ 40 ea.	\$0	SBX \$0	SPL \$328	SPR \$328

Prices

Code	COM												Cuir Leather	
	GRA	GR1	GR2	GR3	GR4	GR5	GR6	GR7	GR8	GR9	GR10	GR11		GR12
6753 PM	2435	2546	2695	2843	3029	3214	3400	3586	3771	3957	4142	4514	4885	4576
6753 WL	2572	2683	2832	2980	3166	3351	3537	3723	3908	4094	4279	4651	5022	4713

How to Order

SS	6753	WL PM (std)	PQD PQS (std)	SBX	SPL SPR	Fabric <i>See the Logiflex Graded-in List</i>		
series	code	legs	top stitch	no button	pivoting shelf	supplier	pattern	color
Example SS	6753	PM	PQS			ENNIS	LOFT	AQUA

Soft Seating

Stelli - Sofa

6757

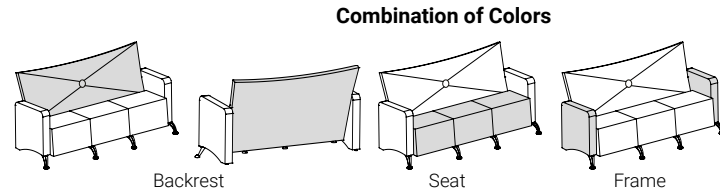
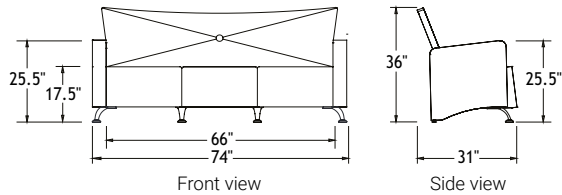
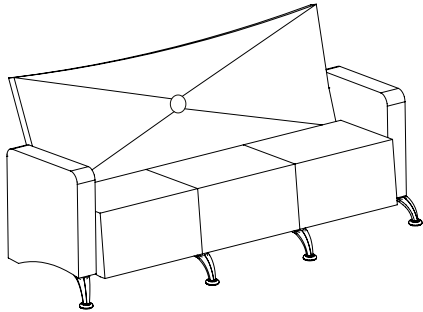

Manufacturing Standards

- 4 metal legs PM (brushed nickel finish) in front and 2 levelers in the back;
- Single top stitching;
- Elastic straps on seat and back;
- Medium-density foam on seat and backrest;
- Firm density foam on the top of the armrests;
- Standard button and "X" stitch in the backrest;
- Frame made out of recycled materials.

Wooden Legs option: 4 wooden legs, WL, 4" x 4" x 3-3/4" levelers, choice of Logiflex wood finishes.

No Button: option to remove the button and the decorative "X" on the backrest.

Pivoting Shelf: 20" x 11-5/8" pivoting shelf of 3/4" hardwood.

Wood finishes: Available colors: White Wash WW, Golden Wheat GW, Sand SD, Apricot AT, Pecan PN, Brandy BR, Chestnut CT, Coffee CF, Espresso ES, Bordeaux BO, Black Wash BW and Bark BK.

Number of yards for COM fabric:

Code	Total	Backrest	Seat	Frame
6757	10	5.5	2.5	3.5

Options

<p>2 Wooden Legs</p> <p>WL \$ 40 ea.</p>	<p>Double Stitching</p> <p>\$0</p>	<p>No Button</p> <p>SBX \$0</p>	<p>Pivoting Shelf</p> <p>Left Right</p> <p>SPL SPR \$328 \$328</p>
---	---	--	---

Prices

Code	GRA	GR1	COM GR2	GR3	GR4	GR5	GR6	GR7	GR8	GR9	GR10	GR11	GR12	Cuir Leather
6757 PM	2727	2892	3112	3332	3607	3882	4157	4432	4707	4982	5257	5807	6357	5899
6757 WL	2914	3079	3299	3519	3794	4069	4344	4619	4894	5169	5444	5994	6544	6086

How to Order

SS	6757	WL PM (std)	PQS (std)	SBX	SPL SPR	Fabric
series	code	legs	top stitch	no button	pivoting shelf	See the Logiflex Graded-in List
Example SS	6757	PM	PQS			ENNIS LOFT AQUA

Soft Seating

Stelli - Armchair

6759

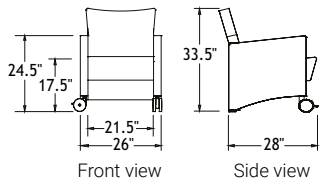
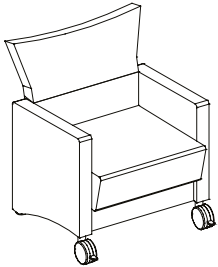

Manufacturing Standards

- 2 standard wheels in front and 2 levelers in the back;
- Single top stitching;
- Elastic straps on seat;
- Medium-density foam on seat and backrest;
- Firm density foam on top of the arms of the chair;
- Fabric handle in the top of the back;
- Frame made out of recycled materials.

Combination of Colors

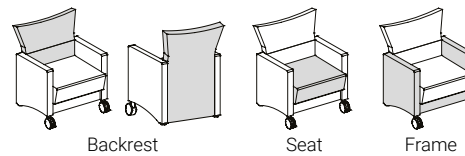

Number of yards for COM fabric:

Code	Total	Backrest	Seat	Frame
6759	4.25	2.25	1.25	3

Options

Double Stitching

\$0

Prices

Code	GRA	GR1	COM GR2	GR3	GR4	GR5	GR6	GR7	GR8	GR9	GR10	GR11	GR12	Cuir Leather
6759	1315	1385	1479	1572	1689	1806	1923	2040	2156	2273	2390	2624	2858	2663

How to Order

SS	6759	PQD PQS (std)	Fabric <i>See the Logiflex Graded-in List</i>		
series	code	top stitch	supplier	pattern	color
Example SS	6759	PQS	ENNIS	LOFT	AQUA

Soft Seating

Taylor - Armchair

TAY1

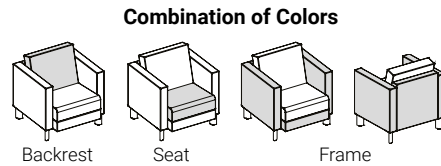
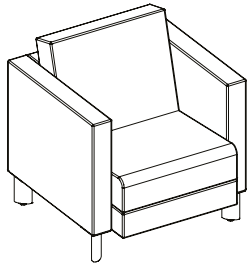

Manufacturing Standards

- Elastic straps on seat;
- Medium-density foam;
- Frame made out of recycled and recyclable particles;
- Oval metal legs 6" H, satin nickel finish.

Number of yards for COM fabric:

Code	Total	Backrest	Seat	Frame
TAY1	4	1	1	3.5

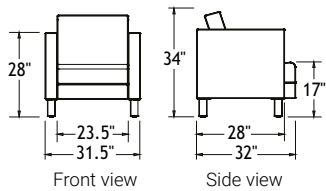

Prices

Code	GRA	GR1	COM GR2	GR3	GR4	GR5	GR6	GR7	GR8	GR9	GR10	GR11	GR12	Cuir Leather
TAY1	1213	1279	1367	1455	1565	1675	1785	1895	2005	2115	2225	2445	2665	2482

How to Order

Fabric
See the Logiflex Graded-in List

SS	TAY1			
series	code	supplier	pattern	color

Example

SS	TAY1	ENNIS	LOFT	AQUA
-----------	-------------	-------	------	------

Soft Seating

Taylor - Loveseat

TAY2

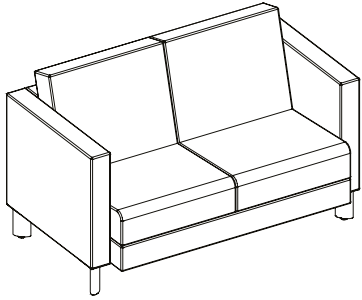

Combination of Colors

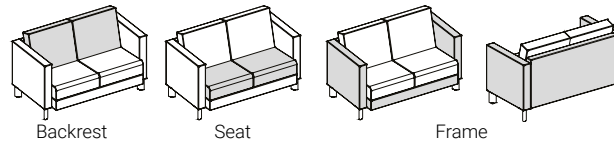

Manufacturing Standards

- Elastic straps on seat;
- Medium-density foam;
- Frame made out of recycled and recyclable particles;
- Oval metal legs 6" H, satin nickel finish.

Number of yards for COM fabric:

Code	Total	Backrest	Seat	Frame
TAY2	5.5	1.5	1.5	5

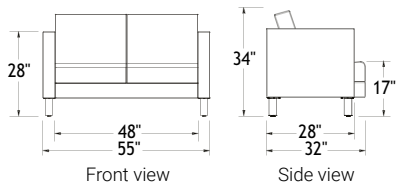

Prices														
Code	GRA	GR1	COM GR2	GR3	GR4	GR5	GR6	GR7	GR8	GR9	GR10	GR11	GR12	Cuir Leather
TAY2	1630	1721	1842	1963	2114	2266	2417	2568	2719	2871	3022	3324	3627	3375

How to Order

Fabric

[See the Logiflex Graded-in List](#)

SS	TAY2			
series	code	supplier	pattern	color

Example SS TAY2 ENNIS LOFT AQUA

Soft Seating

Taylor - Sofa

TAY3

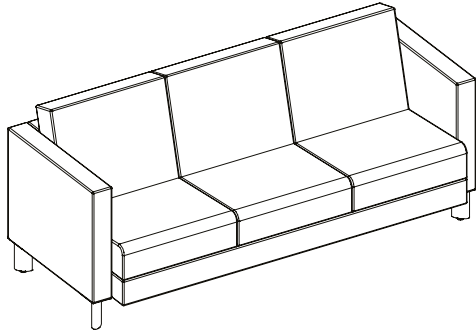

Combination of Colors

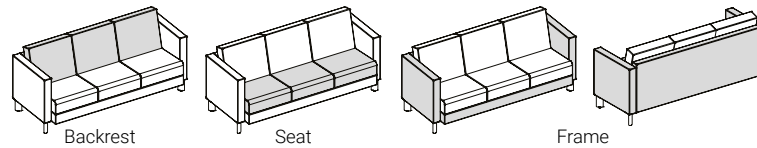

Manufacturing Standards

- Elastic straps on seat;
- Medium-density foam;
- Frame made out of recycled and recyclable particles;
- Oval metal legs 6" H, satin nickel finish.

Number of yards for COM fabric:

Code	Total	Backrest	Seat	Frame
TAY3	9	2	2.25	7

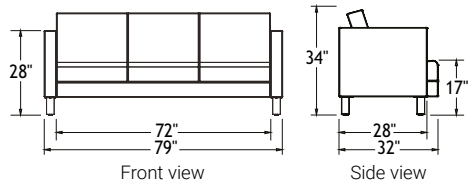

														Prices	
Code	GRA	GR1	COM	GR2	GR3	GR4	GR5	GR6	GR7	GR8	GR9	GR10	GR11	GR12	Cuir Leather
TAY3	2122	2271	2469	2667	2915	3162	3410	3657	3905	4152	4400	4895	5390	4977	

How to Order

Fabric

[See the Logiflex Graded-in List](#)

SS	TAY3			
series	code	supplier	pattern	color

Example SS TAY3 ENNIS LOFT AQUA

Soft Seating

Slim - Lounge Armchair

SL1AB

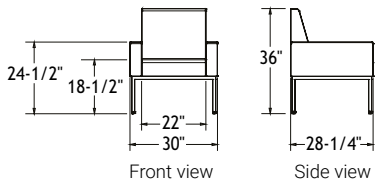
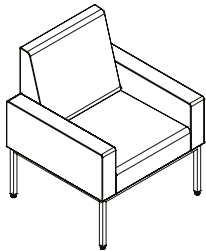

Combination of Colors

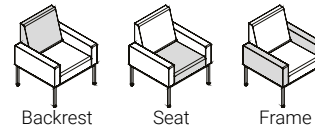

Manufacturing Standards

- Construction in laminated hardwood veneer and hardwood;
- Springs on seat covered with 2" foam and 1/2" polyester;
- Elastic straps on back covered with 1-1/2" foam and 1/2" polyester;
- Arms covered with 1" foam;
- Seating frame base with four 11" high legs in 1" square welded steel profile. On white nylon levelers;
- Single top stitching.

Metal finishes available in satin nickel (SN) and black (BL).

Number of yards for COM fabric:

Code	Total	Backrest	Seat	Frame
SL1AB	3	1.5	1	1.5

+ Options

Double Stitching

\$0

\$ Prices

Code	GRA	GR1	COM GR2	GR3	GR4	GR5	GR6	GR7	GR8	GR9	GR10	GR11	GR12	Cuir Leather
SL1AB	1632	1682	1748	1814	1897	1979	2062	2144	2227	2309	2392	2557	2722	2584

🛒 How to Order

SS	SL1AB	BL SN (std)	PQD PQS (std)	Fabric <i>See the Logiflex Graded-in List</i>			
series	code	metal finish (Appx. A)	top stitching	supplier	pattern	color	
Example	SS	SL1AB	SN	PQS	ENNIS	LOFT	AQUA

Soft Seating

Slim - Loveseat

SL2AB

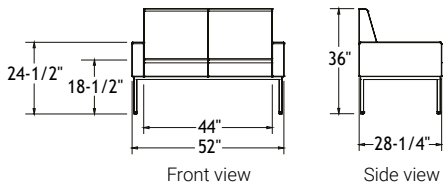
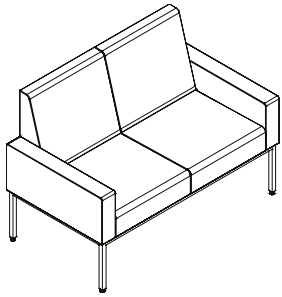

Combination of Colors

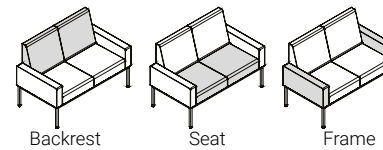

Manufacturing Standards

- Construction in laminated hardwood veneer and hardwood;
- Springs on seat covered with 2" foam and 1/2" polyester;
- Elastic straps on back covered with 1-1/2" foam and 1/2" polyester;
- Arms covered with 1" foam;
- Seating frame base with four 11" high legs in 1" square welded steel profile. On white nylon levelers;
- Single top stitching.

Metal finishes available in satin nickel (SN) and black (BL).

Number of yards for COM fabric:

Code	Total	Backrest	Seat	Frame
SL2AB	4,75	2	1,25	1,5

Options

Double Stitching

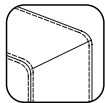

\$0

Prices

Code	GRA	GR1	COM GR2	GR3	GR4	GR5	GR6	GR7	GR8	GR9	GR10	GR11	GR12	Cuir Leather
SL2AB	2337	2415	2520	2624	2755	2885	3016	3147	3277	3408	3538	3800	4061	3843

How to Order

SS	SL2AB	BL SN (std)	PQD PQS (std)	Fabric <i>See the Logiflex Graded-in List</i>			
series	code	metal finish (Appx. A)	top stitching	supplier	pattern	color	
Example	SS	SL2AB	SN	PQS	ENNIS	LOFT	AQUA

Soft Seating

Slim - Sofa

SL3AB

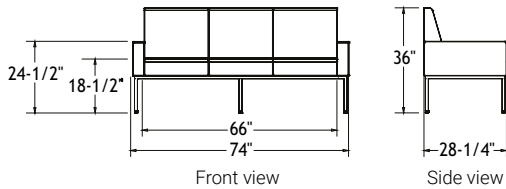
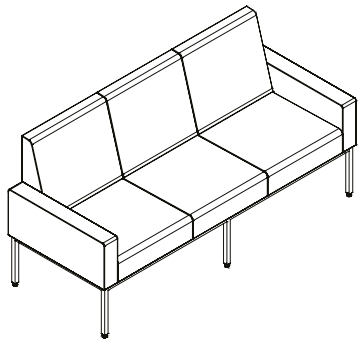

Combination of Colors

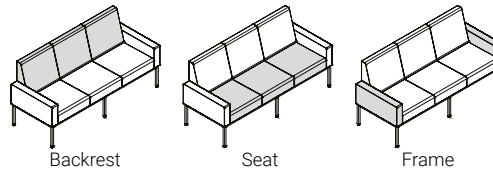

Manufacturing Standards

- Construction in laminated hardwood veneer and hardwood;
- Springs on seat covered with 2" foam and 1/2" polyester;
- Elastic straps on back covered with 1-1/2" foam and 1/2" polyester;
- Arms covered with 1" foam;
- Seating frame base with six 11" high legs in 1" square welded steel profile. On white nylon levelers;
- Single top stitching.

Metal finishes available in satin nickel (SN) and black (BL).

Number of yards for COM fabric:

Code	Total	Backrest	Seat	Frame
SL3AB	7	3,5	2	1,5

Options

Double Stitching

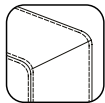

\$0

Prices

Code	GRA	GR1	COM GR2	GR3	GR4	GR5	GR6	GR7	GR8	GR9	GR10	GR11	GR12	Cuir Leather
SL3AB	3005	3121	3275	3429	3622	3814	4007	4199	4392	4584	4777	5162	5547	5226

How to Order

SS	SL3AB	BL SN (std)	PQD PQS (std)	Fabric <i>See the Logiflex Graded-in List</i>			
series	code	metal finish (Appx. A)	top stitching	supplier	pattern	color	
Example	SS	SL3AB	SN	PQS	ENNIS	LOFT	AQUA

Soft Seating

Slim - Lounge Chair

SL1SB

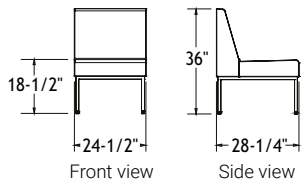
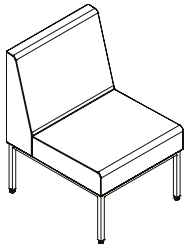

Combination of Colors

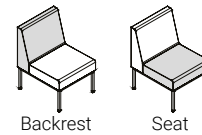

Manufacturing Standards

- Construction in laminated hardwood veneer and hardwood;
- Springs on seat covered with 2" foam and 1/2" polyester;
- Elastic straps on back covered with 1-1/2" foam and 1/2" polyester;
- Seating frame base with four 11" high legs in 1" square welded steel profile. On white nylon levelers;
- Single top stitching.

Metal finishes available in satin nickel (SN) and black (BL).

Number of yards for COM fabric:

Code	Total	Backrest	Seat
SL1SB	2	1.5	1

Options

Double Stitching

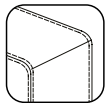

\$0

Prices

Code	GRA	GR1	COM GR2	GR3	GR4	GR5	GR6	GR7	GR8	GR9	GR10	GR11	GR12	Cuir Leather
SL1SB	1317	1350	1394	1438	1493	1548	1603	1658	1713	1768	1823	1933	2043	1951

How to Order

SS	SL1SB	BL SN (std)	PQD PQS (std)	Fabric <i>See the Logiflex Graded-in List</i>			
series	code	metal finish (Appx. A)	top stitching	supplier	pattern	color	
Example	SS	SL1SB	SN	PQS	ENNIS	LOFT	AQUA

Soft Seating

Slim - Armless Loveseat

SL2SB

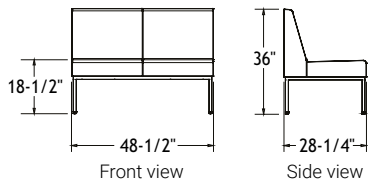
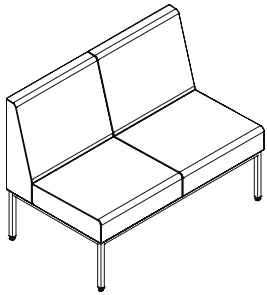

Combination of Colors

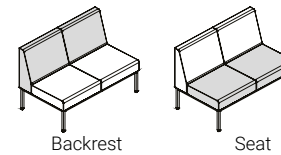

Manufacturing Standards

- Construction in laminated hardwood veneer and hardwood;
- Springs on seat covered with 2" foam and 1/2" polyester;
- Elastic straps on back covered with 1-1/2" foam and 1/2" polyester;
- Seating frame base with four 11" high legs in 1" square welded steel profile. On white nylon levelers;
- Single top stitching.

Metal finishes available in satin nickel (SN) and black (BL).

Number of yards for COM fabric:

Code	Total	Backrest	Seat
SL2SB	3.25	2	1.25

Options

Double Stitching

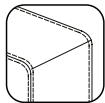

\$0

Prices

Code	GRA	GR1	COM GR2	GR3	GR4	GR5	GR6	GR7	GR8	GR9	GR10	GR11	GR12	Cuir Leather
SL2SB	2000	2054	2126	2197	2286	2376	2465	2555	2644	2733	2823	3001	3180	3031

How to Order

SS	SL2SB	BL SN (std)	PQD PQS (std)	Fabric <i>See the Logiflex Graded-in List</i>			
series	code	metal finish (Appx. A)	top stitching	supplier	pattern	color	
Example	SS	SL2SB	SN	PQS	ENNIS	LOFT	AQUA

Soft Seating

Slim - Armless Sofa

SL3SB

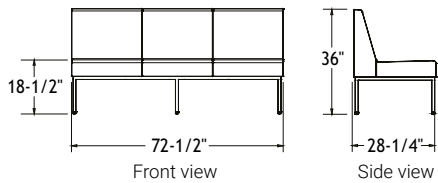
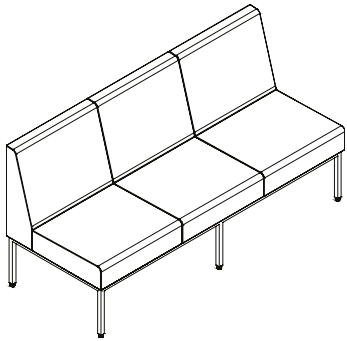

Combination of Colors

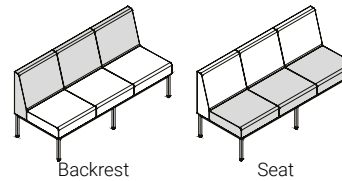

Manufacturing Standards

- Construction in laminated hardwood veneer and hardwood;
- Springs on seat covered with 2" foam and 1/2" polyester;
- Elastic straps on back covered with 1-1/2" foam and 1/2" polyester;
- Seating frame base with six 11" high legs in 1" square welded steel profile. On white nylon levelers;
- Single top stitching.

Metal finishes available in satin nickel (SN) and black (BL).

Number of yards for COM fabric:

Code	Total	Backrest	Seat
SL3SB	5.5	3.5	2

Options

Double Stitching

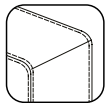

\$0

Prices

Code	GRA	GR1	COM GR2	GR3	GR4	GR5	GR6	GR7	GR8	GR9	GR10	GR11	GR12	Cuir Leather
SL3SB	2704	2795	2916	3037	3188	3340	3491	3642	3793	3945	4096	4398	4701	4449

How to Order

SS	SL3SB	BL SN (std)	PQD PQS (std)	Fabric <i>See the Logiflex Graded-in List</i>			
series	code	metal finish (Appx. A)	top stitching	supplier	pattern	color	
Example	SS	SL3SB	SN	PQS	ENNIS	LOFT	AQUA

Soft Seating

Slim - Small Coffee Table

SL1T

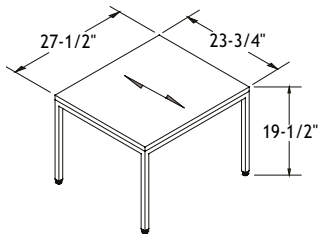

Manufacturing Standards

- 1" rectangular laminate top;
- Table frame base with four 18" high legs in 1" square welded steel profile.
- On white nylon levelers;
- Height: 19.5".

Metal finishes available in satin nickel (SN) and black (BL).

Prices

Code	
SL1T	495

How to Order

OS	SL1T	BL SN (std)
series	code	metal finish (Appx. A)

Example **OS** **SL1T** **SN**

Soft Seating

Slim - Large Coffee Table

SL2T

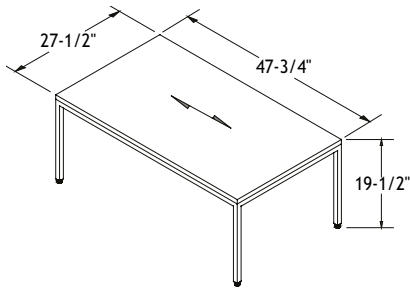

Manufacturing Standards

- 1" rectangular laminate top;
- Table frame base with four 18" high legs in 1" square welded steel profile.
- On white nylon levelers;
- Height: 19.5".

Metal finishes available in satin nickel (SN) and black (BL).

Prices

Code	
SL2T	608

How to Order

OS	SL2T	BL SN (std)
series	code	metal finish (Appx. A)

Example OS SL2T SN

Chairs

Appendix - MADRID - Options

Back Height



L Low back



M Medium back

Structure

UW wooden shell with seat cushion

UU fully upholstered chair

WW wooden shell

US HPL shell with seat cushion

SS HPL shell

Base



04 4 legs



T424 Stool 24"H
T429 Stool 29"H

Legs



G Glides



T Teflon glide
\$35

Metal



BL Black



CHR Chrome

Wood



GW Golden Wheat

HPL



W Polar White



B Jet Black

Chairs

Madrid - High Back - Wood or Upholstered

MD - MUW



MD - MUU

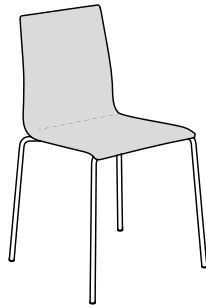

MD - MWW



A Backrest width	15,75"
B Chair depth	20,5"
C Chair height	35"
D Seat height	18,75"
E Seat depth	16,5"
F Chair width	19,5"

Manufacturing Standards

Madrid chair:

- Wooden shell, golden wheat finish (GW),
 - MD-MUW: wooden shell with seat cushion;
 - MD-MUU: fully upholstered chair;
 - MD-MWW: wooden shell;
- Metal base with 4 legs, Black (BL) or Chrome (CHR) finish,
- Base on glides:
 - glides (G) or Teflon glides (T)
- Stackable up to 10 (using a trolley);
- Weight and volume (for 3 chairs): 35 lbs / 16 ft³;

SFP option: Plastic protector fixed under the seat to protect the fabric when the chairs are stacked.

Compatible with the **XO-10** trolley for stacking chairs.

Fabric finishes: Selection of fabrics or vinyl by the customer from the supplier of their choice.

Number of yards for COM fabric:

Code	Total
UW	0,62
UU	1,5

Options

Protector



SFP
\$25

Legs



G
\$0

T
\$35

Prices

MD

Code	COM													Cuir
	GRA	GR1	GR2	GR3	GR4	GR5	GR6	GR7	GR8	GR9	GR10	GR11	GR12	Leather
UW	571	580	589	595	605	615	626	635	645	656	666	686	706	655
UU	588	609	636	665	699	734	769	803	838	873	907	978	1047	1025

MD - Wood

Code	
WW	485

How to Order

LC	-	MD	-	M	-	04	-	G	-	BL	-	GW	-	Combination of Colors			SFP
serie		code		Back height		Base		Legs		Metal finish		Wood finish		supplier	pattern	color	Protector

Fabrics
*See the fabric chart
Logiflex grade*

Example LC - MD - M - UW - 04 - G - BL - GW - ENNIS - LOFT - AQUA - SFP

Chairs

Madrid - High Back - HPL

MD - MUS

MD - MSS

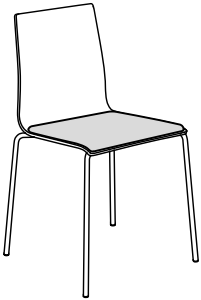

A Backrest width	15,75"
B Chair depth	20,5"
C Chair height	35"
D Seat height	18,75"
E Seat depth	16,5"
F Chair width	19,5"

Manufacturing Standards

Madrid chair:

- HPL shell, Intense Black (B) or Polar White (W) finish,
 - MD-MUS: HPL shell with seat cushion
 - MD-MSS: HPL shell
- Metal base with 4 legs, Black (BL) or Chrome (CHR) finish,
- Base on glides:
 - glides (G) or Teflon glides (T)
- Stackable up to 10 (using a trolley);
- Weight and volume (for 3 chairs): 35 lbs / 16 ft³;

SFP option: Plastic protector fixed under the seat to protect the fabric when the chairs are stacked.

Compatible with the **XO-10** trolley for stacking chairs.

Fabric finishes: Selection of fabrics or vinyl by the customer from the supplier of their choice.

Number of yards for COM fabric:

Code	Total
US	0,62

Options

Protector

Chair options



SFP

See [Appendix Madrid](#) for complete options

Prices

MD

Code	GRA	GR1	COM GR2	GR3	GR4	GR5	GR6	GR7	GR8	GR9	GR10	GR11	GR12	Cuir Leather
US	674	684	691	699	709	720	729	740	749	759	770	789	810	758

MD - HPL

Code	
SS	589

How to Order

Combination of Colors

Fabrics
See the fabric chart
Logiflex grade

LC	MD	M	US SS	04	G T	BL CHR	W B	Supplier	Pattern	Color	SFP
serie	code	Back height	Structure	Base	Legs	Metal finish	HPL finish				Protector
Example LC	MD	M	SS	04	G	BL	W	ENNIS	LOFT	AQUA	SFP

Chairs

Madrid - Stool (24") Counter Height - Wood or Upholstered

MD - LUW



MD - LUU

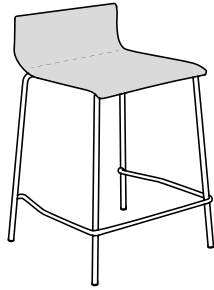

MD - LWW

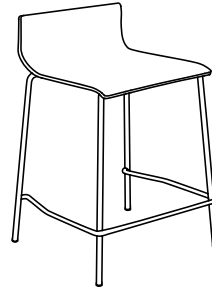

A Backrest width	15,75"
B Chair depth	18,75"
C Chair height	33,5"
D Seat height	24"
E Seat depth	16"
F Chair width	19,5"

Manufacturing Standards

Madrid stool, counter height (24"H):

- Wooden shell, golden wheat finish (GW),
 - MD-LUW: wooden shell with seat cushion
 - MD-LUU: fully upholstered chair;
 - MD-LWW: wooden shell
- Metal base with 4 legs, Black (BL) or Chrome (CHR) finish,
- Base on glides:
 - glides (G) or Teflon glides (T)
- Weight and volume (for 3 chairs): 25 lbs / 8 ft³;

Fabric finishes: Selection of fabrics or vinyl by the customer from the supplier of their choice.

Number of yards for COM fabric:

Code	Total
UW	0,62
UU	1,2

Options

Chair options



See [Appendix Madrid](#) for complete options

Prices

MD

Code	COM													Cuir
	GRA	GR1	GR2	GR3	GR4	GR5	GR6	GR7	GR8	GR9	GR10	GR11	GR12	Leather
UW	790	797	807	814	823	835	844	854	864	875	884	904	925	874
UU	750	765	788	810	837	864	891	919	946	973	1001	1055	1110	1136

MD - Wood

Code	
WW	704

How to Order

Combination of Colors

Fabrics
See the fabric chart
Logiflex grade

LC	-	MD	-	L	-	T424	-	G	-	BL	-	GW	-				
serie		code		Back height		Base		Legs		Metal finish		Wood finish		supplier	pattern	color	
Example	LC	-	MD	-	L	-	T424	-	G	-	BL	-	GW	-	ENNIS	LOFT	AQUA

Chairs

Madrid - Stool (29"H) Bar Height - Wood or upholstered

MD - LUW

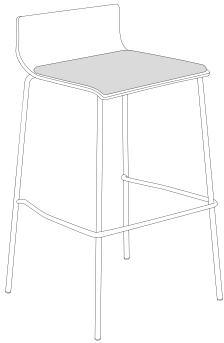

MD - LUU

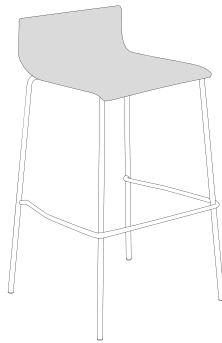

MD - LWW

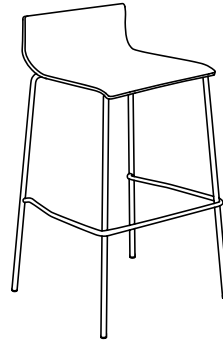

A Backrest width	15,75"
B Chair depth	18,75"
C Chair height	38,5"
D Seat height	29"
E Seat depth	16"
F Chair width	19,5"

Manufacturing Standards

Madrid stool, bar height (29"H):

- Wooden shell, golden wheat finish (GW),
 - MD-LUW: wooden shell with seat cushion
 - MD-LUU: fully upholstered chair;
 - MD-LWW: wooden shell
- Metal base with 4 legs, Black (BL) or Chrome (CHR) finish,
- Base on glides:
 - glides (G) or Teflon glides (T)
- Weight and volume (for 3 chairs): 25 lbs / 8 ft³;
- Use with a 42"H top.

Fabric finishes: Selection of fabrics or vinyl by the customer from the supplier of their choice.

Number of yards for COM fabric:

Code	Total
UW	0,62
UU	1,2

Options

Chair options



See [Appendix Madrid](#) for complete options

Prices

MD

Code	COM													Cuir
	GRA	GR1	GR2	GR3	GR4	GR5	GR6	GR7	GR8	GR9	GR10	GR11	GR12	Leather
UW	790	797	807	814	823	835	844	854	864	875	884	904	925	874
UU	750	765	788	810	837	864	891	919	946	973	1001	1055	1110	1136

MD - Wood

Code	
WW	704

How to Order

Combination of Colors

Fabrics
See the fabric chart
Logiflex grade

LC	-	MD	-	L	-	T429	-	G	-	BL	-	GW	-					
serie		code		Back height		Base		Legs		Metal finish		Wood finish		supplier	pattern	color		
Example	LC	-	MD	-	L	UU	-	T429	-	G	-	BL	-	GW	-	ENNIS	LOFT	AQUA

Chairs

Madrid - Stool (24"H) Counter Height - HPL

MD - LUS

MD - LSS

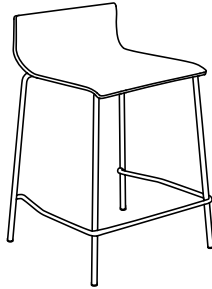

A Backrest width	15,75"
B Chair depth	18,75"
C Chair height	33,5"
D Seat height	24"
E Seat depth	16"
F Chair width	19,5"

Manufacturing Standards

Madrid stool, counter height (24"H):

- HPL shell, Intense Black (B) or Polar White (W) finish,
 - MD-LUS: HPL shell with seat cushion
 - MD-LSS: HPL shell
- Metal base with 4 legs, Black (BL) or Chrome (CHR) finish,
- Base on glides:
 - glides (G) or Teflon glides (T)
- Weight and volume (for 3 chairs): 25 lbs / 8 ft³;

Fabric finishes: Selection of fabrics or vinyl by the customer from the supplier of their choice.

Number of yards for COM fabric:

Code	Total
US	0,62

Options

Chair options



See [Appendix Madrid](#) for complete options

Prices

MD

Code	GRA	GR1	COM GR2	GR3	GR4	GR5	GR6	GR7	GR8	GR9	GR10	GR11	GR12	Cuir Leather
US	886	896	904	910	922	931	942	951	962	971	983	1001	1022	970

MD - HPL

Code	
SS	801

How to Order

Combination of Colors

Fabrics
See the fabric chart
Logiflex grade

LC	-	MD	-	L	US	-	T424	-	G	-	BL	-	W	-			
serie		code		Back height	Structure		Base		Legs		Metal finish		HPL finish		supplier	pattern	color

Example LC - MD - L SS - T424 - G - BL - W - ENNIS LOFT AQUA

Chairs

Madrid - Stool (29"H) Bar Height - HPL

MD - LUS

MD - LSS

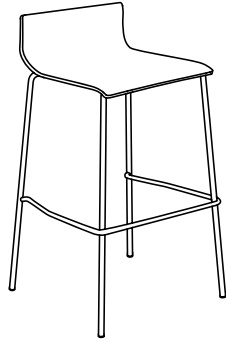
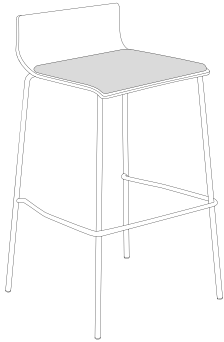

A Backrest width	15,75"
B Chair depth	18,75"
C Chair height	38,5"
D Seat height	29"
E Seat depth	16"
F Chair width	19,5"

Manufacturing Standards

Madrid stool, bar height (29"H):

- HPL shell, Intense Black (B) or Polar White (W) finish,
 - MD-LUS: HPL shell with seat cushion
 - MD-LSS: HPL shell
- Metal base with 4 legs, Black (BL) or Chrome (CHR) finish,
- Base on glides:
 - glides (G) or Teflon glides (T)
- Weight and volume (for 3 chairs): 25 lbs / 8 ft³,
- Use with a 42"H top.

Fabric finishes: Selection of fabrics or vinyl by the customer from the supplier of their choice.

Number of yards for COM fabric:

Code	Total
US	0,62

Options

Chair options



See [Appendix Madrid](#) for complete options

Prices

MD

Code	GRA	GR1	COM GR2	GR3	GR4	GR5	GR6	GR7	GR8	GR9	GR10	GR11	GR12	Cuir Leather
US	886	896	904	910	922	931	942	951	962	971	983	1001	1022	970

MD - HPL

Code	
SS	801

How to Order

Combination of Colors

Fabrics
See the fabric chart
Logiflex grade

LC	-	MD	-	L	US SS	-	T429	-	G T	-	BL CHR	-	W B	-	supplier	pattern	color
serie		code		Back height	Structure		Base		Legs		Metal finish		HPL finish				

Example LC - MD - L SS - T429 - G - BL - W - ENNIS LOFT AQUA

Chairs



Cart (Madrid - Stack6)

MD-10



A Chair width	20"
B Chair depth	25"
C Chair height	36"

Manufacturing Standards

Cart (Madrid, Stack6) :

- Cart for stacking chairs.
- Silver painted steel with handle.
- Black casters with brakes.
- 10 stacked chair capacity.

Prices

Code

MD-10 420

How to Order

LC	MD-10
serie	code

Example **LC** **MD-10**

Chairs

Sedia - Chairs

803

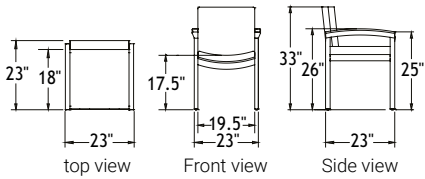
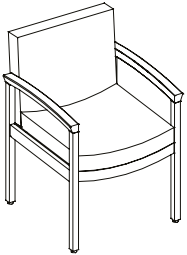

Combination of Colors

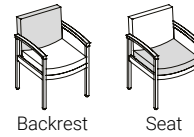

Manufacturing Standards

- Single top stitching;
- Elastic straps on seat and back;
- Medium-density foam on seat;
- Low density foam on back;
- Frame made out of hardwood.

Wood finishes: Available colors: White Wash WW, Golden Wheat GW, Sand SD, Apricot AT, Pecan PN, Brandy BR, Chestnut CT, Coffee CF, Espresso ES, Bordeaux BO, Black Wash BW and Bark BK.

Number of yards for COM fabric:

Code	Total	Backrest	Seat
803	2	2	2

Options

Double Stitching

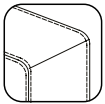

\$0

Prices

Code	GRA	GR1	COM GR2	GR3	GR4	GR5	GR6	GR7	GR8	GR9	GR10	GR11	GR12	Cuir Leather
803	987	1020	1064	1108	1163	1218	1273	1328	1383	1438	1493	1603	1713	1621

How to Order

		PQD PQS (std)		Combination of Colors			
				Finishes <i>See the Logiflex Color Guide</i>		Fabric <i>See the Logiflex Graded-in List</i>	
SS	803						
series	code	top stitch	base	supplier	pattern	color	
Example	SS	803	PQS	BO	ENNIS	LOFT	AQUA

Chairs

Sedia - Chairs

804

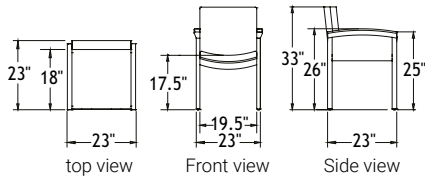
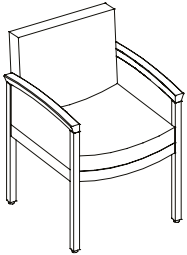

Combination of Colors

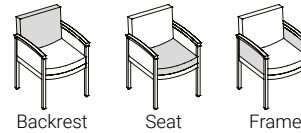

Discontinued Product

Manufacturing Standards

- Single top stitching;
- Elastic straps on seat and back;
- Medium-density foam on seat;
- Low density foam on back;
- Frame made out of hardwood.

Wood finishes: Available colors: White Wash WW, Golden Wheat GW, Sand SD, Apricot AT, Pecan PN, Brandy BR, Chestnut CT, Coffee CF, Espresso ES, Bordeaux BO, Black Wash BW and Bark BK.

Number of yards for COM fabric:

Code	Total	Backrest	Seat	Frame
804	2	2	2	,75

Options

Double Stitching

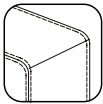

\$0

Prices

Code	GRA	GR1	COM GR2	GR3	GR4	GR5	GR6	GR7	GR8	GR9	GR10	GR11	GR12	Cuir Leather
804	1131	1164	1208	1252	1307	1362	1417	1472	1527	1582	1637	1747	1857	1765

How to Order

		PQD PQS (std)		Combination of Colors			
		Finishes <i>See the Logiflex Color Guide</i>		Fabric <i>See the Logiflex Graded-in List</i>			
SS	804						
series	code	top stitch	base	supplier	pattern	color	
Example	SS	804	PQS	BO	ENNIS	LOFT	AQUA

Chairs

Milan Bold - Armchair with Plywood Back

BAC

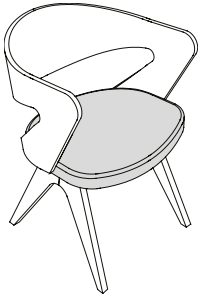

BACC

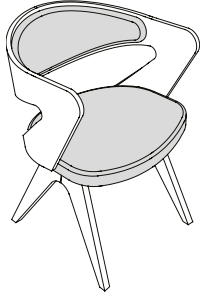

Note: The upholstered back cushion cannot be in vinyl or leather. It is also not recommended to use a pattern fabric on the upholstered back cushion.

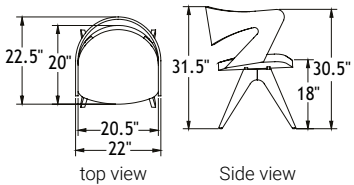

Combination of Colors

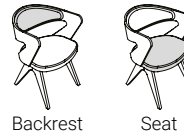

Manufacturing Standards

- Back construction in laminated hardwood veneer;
- Upholstered seat with single top stitching;
- Legs in hardwood;
- **BACC:** cushion added to backrest.

Wood finishes: Available colors: White Wash WW, Golden Wheat GW, Sand SD, Apricot AT, Pecan PN, Brandy BR, Chestnut CT, Coffee CF, Espresso ES, Bordeaux BO, Black Wash BW and Bark BK.

Number of yards for COM fabric:

Code	Total	Backrest	Seat
BAC	.75	-	.75
BACC	1.25	.5	.75

Options

Legs

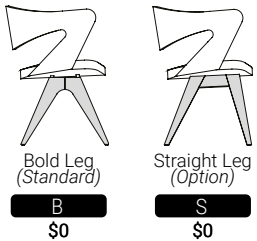

Prices

Code	GRA	GR1	COM GR2	GR3	GR4	GR5	GR6	GR7	GR8	GR9	GR10	GR11	GR12	Cuir Leather
BAC	1220	1232	1249	1265	1286	1306	1327	1348	1368	1389	1409	1451	1492	1458
BACC	1301	1322	1350	1377	1411	1446	1480	1515	1549	1583	1618	1686	1755	1698

How to Order

+			Combination of Colors					
BAC BACC		S B (std)	Finishes <i>See the Logiflex Color Guide</i>		Fabric <i>See the Logiflex Graded-in List</i>			
MN								
series	product	leg	back color	leg color	supplier	pattern	color	
Example MN	BAC	B	GW	GW	ENNIS	LOFT	AQUA	

Chairs

Milan - Armchair with Plywood Back

AC

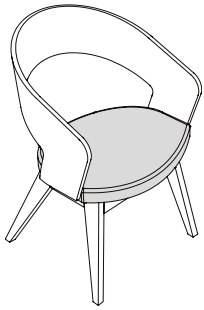

ACC

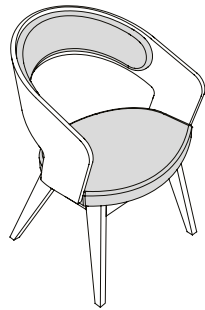

Note: The upholstered back cushion cannot be in vinyl or leather. It is also not recommended to use a pattern fabric on the upholstered back cushion.

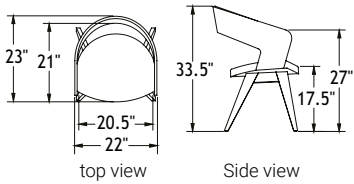

Combination of Colors

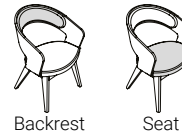

Manufacturing Standards

- Back construction in laminated hardwood veneer;
- Upholstered seat with single top stitching;
- Straight legs in hardwood;
- **ACC:** cushion added to backrest.

Wood finishes: Available colors: White Wash WW, Golden Wheat GW, Sand SD, Apricot AT, Pecan PN, Brandy BR, Chestnut CT, Coffee CF, Espresso ES, Bordeaux BO, Black Wash BW and Bark BK.

Number of yards for COM fabric:

Code	Total	Backrest	Seat
AC	.75	-	.75
ACC	1	.5	.75

Options

Legs

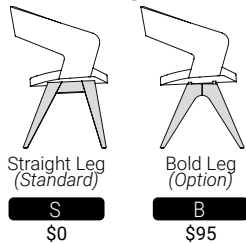

Prices

Code	GRA	GR1	COM GR2	GR3	GR4	GR5	GR6	GR7	GR8	GR9	GR10	GR11	GR12	Cuir Leather
AC	1213	1225	1242	1258	1279	1299	1320	1341	1361	1382	1402	1444	1485	1451
ACC	1300	1317	1339	1361	1389	1416	1444	1471	1499	1526	1554	1609	1664	1618

How to Order

			Combination of Colors					
			Finishes <i>See the Logiflex Color Guide</i>		Fabric <i>See the Logiflex Graded-in List</i>			
MN	AC ACC	B S (std)	back color	leg color	supplier	pattern	color	
Example MN	AC	S	GW	GW	ENNIS	LOFT	AQUA	

Chairs

Milan - Armchair with Upholstered Back

ACU

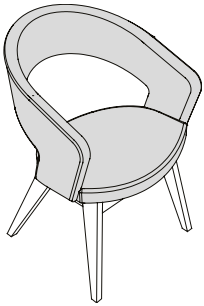

Note: The upholstered back cannot be in vinyl or leather. It is also not recommended to use a pattern fabric on the upholstered back.

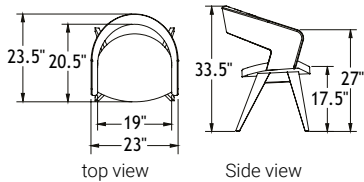

Combination of Colors

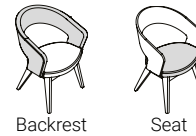

Manufacturing Standards

- Upholstered back with single top stitching;
- Upholstered seat with single top stitching;
- Straight legs in hardwood.

Wood finishes: Available colors: White Wash WW, Golden Wheat GW, Sand SD, Apricot AT, Pecan PN, Brandy BR, Chestnut CT, Coffee CF, Espresso ES, Bordeaux BO, Black Wash BW and Bark BK.

Number of yards for COM fabric:

Code	Total	Backrest	Seat
ACU	2	1.5	.75

Options

Legs

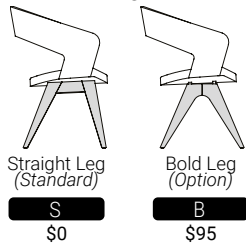

Prices

Code	GRA	GR1	COM GR2	GR3	GR4	GR5	GR6	GR7	GR8	GR9	GR10	GR11	GR12	Cuir Leather
ACU	1222	1255	1299	1343	1398	1453	1508	1563	1618	1673	1728	1838	1948	1856

How to Order

+		Combination of Colors				
+		Finishes <i>See the Logiflex Color Guide</i>		Fabric <i>See the Logiflex Graded-in List</i>		
MN	ACU	B S (std)				
series	product	leg	leg color	supplier	pattern	color
Example MN	ACU	S	GW	ENNIS	LOFT	AQUA

Chairs

Milan - Chair with Plywood Back

CH

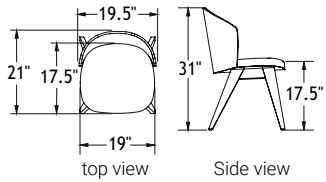
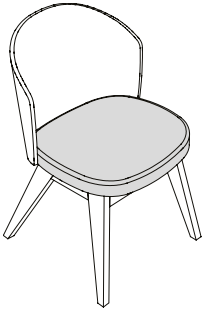

Manufacturing Standards

- Back construction in laminated hardwood veneer;
- Upholstered seat with single top stitching;
- Straight legs in hardwood.

Wood finishes: Available colors: White Wash WW, Golden Wheat GW, Sand SD, Apricot AT, Pecan PN, Brandy BR, Chestnut CT, Coffee CF, Espresso ES, Bordeaux BO, Black Wash BW and Bark BK.

Number of yards for COM fabric:

Code	Total
CH	.75

Options

Legs

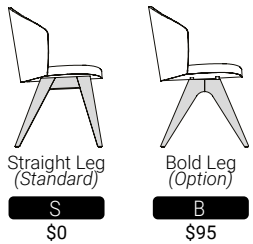

Straight Leg
(Standard)
S
\$0

Bold Leg
(Option)
B
\$95

Prices

Code	GRA	GR1	COM GR2	GR3	GR4	GR5	GR6	GR7	GR8	GR9	GR10	GR11	GR12	Cuir Leather
CH	1024	1036	1053	1069	1090	1110	1131	1152	1172	1193	1213	1255	1296	1262

How to Order

Combination of Colors



B
S (std)

Finishes
See the Logiflex
Color Guide

Fabric
See the Logiflex Graded-in List

MN	CH	B S (std)	back color	leg color	supplier	pattern	color
series	product	leg					

Example MN CH S GW GW ENNIS LOFT AQUA

Chairs

Milan - Chair with Upholstered Back

CHU

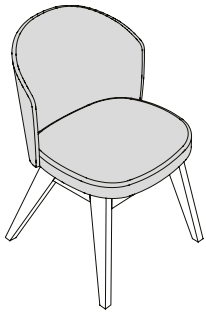

Note: The upholstered back cannot be in vinyl or leather. It is also not recommended to use a pattern fabric on the upholstered back.

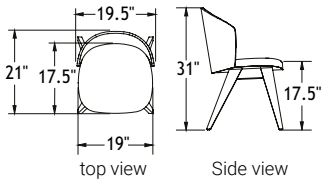

Combination of Colors

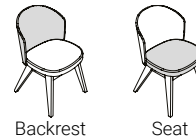

Manufacturing Standards

- Upholstered back with single top stitching;
- Upholstered seat with single top stitching;
- Straight legs in hardwood.

Wood finishes: Available colors: White Wash WW, Golden Wheat GW, Sand SD, Apricot AT, Pecan PN, Brandy BR, Chestnut CT, Coffee CF, Espresso ES, Bordeaux BO, Black Wash BW and Bark BK.

Number of yards for COM fabric:

Code	Total	Backrest	Seat
CHU	1.5	1.25	.75

Options

Legs

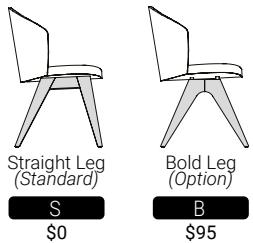

Prices

Code	GRA	GR1	COM GR2	GR3	GR4	GR5	GR6	GR7	GR8	GR9	GR10	GR11	GR12	Cuir Leather
CHU	1089	1114	1147	1180	1221	1263	1304	1345	1386	1428	1469	1551	1634	1565

How to Order

Finishes <i>See the Logiflex Color Guide</i>			Combination of Colors <i>See the Logiflex Graded-in List</i>			
MN	CHU	B S (std)	leg color	supplier	pattern	color
Example MN	CHU	S	GW	ENNIS	LOFT	AQUA

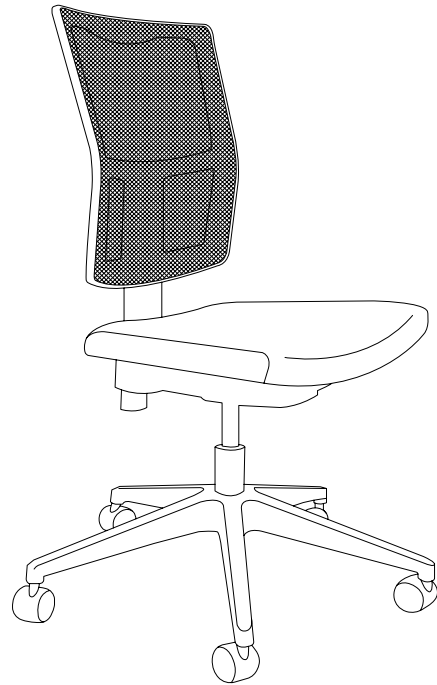

Cyrus Task Seating

This chair is designed with sleek lines, so it fits well in any setting. With a medium fabric mesh backrest, the Cyrus is your go-anywhere chair.

Appendix - CYRUS - Options

Chair bases



VN Black nylon tapered base



ZN Black nylon rounded base



VC Aluminium tapered base
\$145



ZC Aluminium rounded base
\$145



01 Sled base

Mecanism

Mecanism 41
\$50

Options

S Seat sliding option
\$75

Arms



NA
• No arms



F7 Fixed aluminium arms
\$255



F61 Fixed T shaped arms
\$125



FD Closed fixed arms
\$125



FG Open fixed arms
\$125



AD Adjustable arms
\$125



AS Adjustable arms
\$125



AZ Adjustable arms with multi-axis
and pivot armrests
\$255



FZ Fixed arms
\$255

Legs



H Casters for carpeting



S Casters for hard surfaces



G Nylon glides

Task Seating

Cyrus - Chair - Medium back

CYRUS

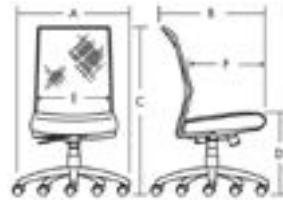
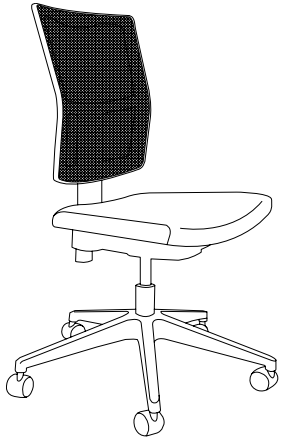

A Chair width	26"
B Chair depth	24"
C Chair height	39,5" - 44,5"
D Seat height	17" - 22"
E Backrest width	19,5"
F Seat depth	18,5"

Manufacturing Standards

Cyrus chair

- Medium back in black mesh fabric hugging the curve of the back;
- Seat with polyurethane foam;
- Choice of adjustable or fixed armrests;
- Choice of black nylon or aluminum base with casters;
- Weight of 40 lbs and volume of 10ft³;

Fabric finishes: Selection of fabrics or vinyl by the customer from the supplier of their choice.

Number of yards for COM fabric:

Code	Total
CYRUS	0,8

Options

Chair options



See [Appendix F](#) for complete options

Prices

Code	GRA	GR1	COM	GR2	GR3	GR4	GR5	GR6	GR7	GR8	GR9	GR10	GR11	GR12	Cuir Leather
CY	735	757	780	802	828	855	882	910	938	964	992	1047	1102	974	

Bases

ZN - VN \$0
ZC - VC \$145

Mecanism

41 \$50

Option

S \$75

Arms

NA \$0
AS - AD - FG - FD - F61 \$125

AZ - FZ - F7 \$255

Legs

H - S - G \$0

How to Order

											Combination of Colors						
											Fabrics <i>See the fabric chart Logiflex grade</i>						
LC-	CY	-	MWE	-	ZN	41	S	NA, AS, AD, F61, FG, FD, AZ, F7, FZ	H	S	G	ENNIS	LOFT	AQUA	-	MB06	
serie	Structure		base	mechanism	Option	arm	leg	supplier	pattern	color	Mesh fabric						
Example	LC-	CY	-	MWE	-	ZN	41	S	-	NA	-	H	ENNIS	LOFT	AQUA	-	MB06

Task Seating

Cyrus - Visitor chair with sled base - Medium back

CYRUS

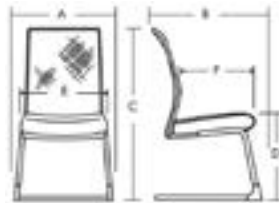
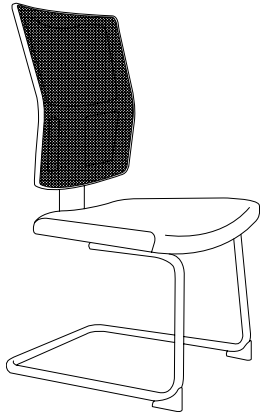

A Chair width	23"
B Chair depth	24"
C Chair height	40,5"
D Seat height	18"
E Backrest width	19,5"
F Seat depth	18,5"

Manufacturing Standards

Cyrus chair

- Medium back in black mesh fabric hugging the curve of the back;
- Seat with polyurethane foam;
- Choice of adjustable or fixed armrests;
- Choice of black nylon or aluminum base with casters;
- Weight of 40 lbs and volume of 10ft³;

Fabric finishes: Selection of fabrics or vinyl by the customer from the supplier of their choice.

Number of yards for COM fabric:

Code	Total
CYRUS	0,8

Options

Chair options



See [Appendix F](#) for complete options

Prices

Code	GRA	GR1	COM GR2	GR3	GR4	GR5	GR6	GR7	GR8	GR9	GR10	GR11	GR12	Cuir Leather
CY	712	734	756	777	805	832	860	887	915	941	970	1023	1078	951

Arms

NA

\$0

AS - AD - FG - FD - F61

\$125

AZ - FZ - F7

\$255

How to Order

Combination of Colors

NA, AS, AD,
F61, FG, FD,
AZ, F7, FZ

Fabrics
[See the fabric chart](#)
[Logiflex grade](#)

LC-	CY	-	MWE	-	01	-		-	N				-	MB06
serie		Structure	sled base	arm	leg	supplier	pattern	color	Mesh fabric					

Example

LC-	CY	-	MWE	-	01	-	NA	-	N	ENNIS	LOFT	AQUA	-	MB06
-----	----	---	-----	---	----	---	----	---	---	-------	------	------	---	------

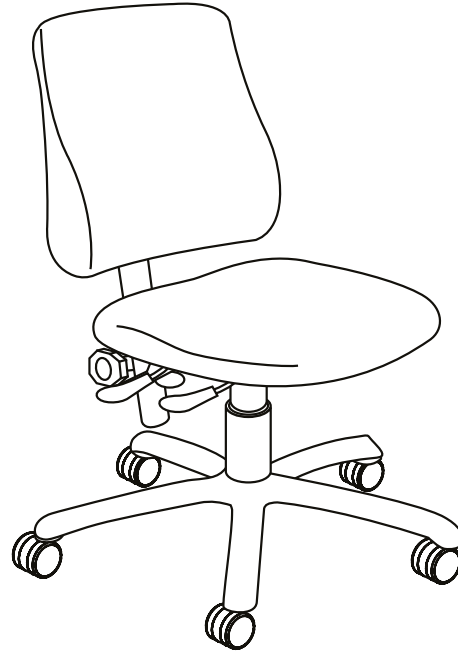

Texto Task Seating

The Texto is Logiflex's most customizable chair, with a variety of different options. Plus, it's ergonomically adjustable with multiple configurations to provide lasting comfort.

Appendix - TEXTO - Options

Chair Width



1 **Narrow seat** (-2")



2 **Standard seat**



3 **Large seat** (+2")
\$145

Chair Back



L **Low back**



M **Medium back**



D **Director back**



H **High back with headrest**

Chair Base



VN **Black nylon tapered base**



ZN **Black nylon rounded base**



VC **Aluminium tapered base**
\$145



ZC **Aluminium rounded base**
\$145



01 **Sled base**



TN **Aluminium rounded stool base**



TC **Aluminium rounded stool base**
\$145

Mechanisms

Mechanism 10 - 11 - 20 - 21

Mechanism 31
\$25

Mechanism 41 - 51
\$50

Mechanism 71
\$105

Mechanism 76F (only with option F)
\$155

Options

S **Seat sliding option**
\$75

R **Back height adjustment option**
\$30

F **Combined options**
\$105



Appendix - TEXTO - Options

Arms



NA
• No arm



AD Adjustable arms
\$125



AS Adjustable arms
\$125



FD Closed fixed arms
\$125



FG Open fixed arms
\$125



FT Open curved fixed arms
\$125



AZ Adjustable arms with multi-axis
and pivot armrests
\$255



FZ Fixed arms
\$255



AG Adjustable arms
\$125



AP Adjustable arms
\$125



AR Adjustable arms
\$125



AW Adjustable arms with pivot
\$125



AX Adjustable arms with multi-axis
armrests
\$200



AY Adjustable arms with multi-axis
and pivot armrests
\$200

Legs



H Casters for carpeting



S Casters for hand surfaces



G Nylon glides



M Mixed (3 casters, 2 glides)

Task Seating

Texto - Chair - Low back

TEXTO

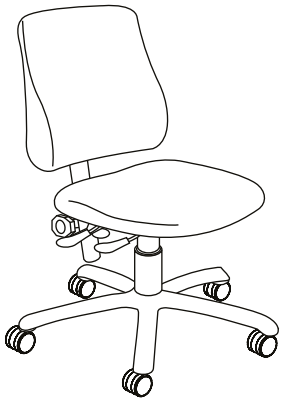

A Chair width	26"
B Chair depth	24"
C Chair height	34" - 39"
D Seat height	17" - 22"
E Backrest width	19"
F Seat depth	18"

Manufacturing Standards

Texto chair:

- Low back following the curve of the back;
- Upholstered seat;
- Choice of black nylon or aluminum base with casters;
- Choice of mechanism;
- Choice of adjustable or fixed arms;
- 40 lbs weight and 10ft³ volume.

Mechanism 76F: Only with option F.

Options: Back height adjustment (R), seat sliding (S).

Fabric finishes: Selection of fabrics or vinyl by the customer from the supplier of their choice.

Number of yards for COM fabric:

Code	Total
TEXTO	1,3

Options

Chair options



See [Appendix F](#) for complete options

Prices

Code	GRA	GR1	COM GR2	GR3	GR4	GR5	GR6	GR7	GR8	GR9	GR10	GR11	GR12	Cuir Leather
TX	737	765	794	822	858	891	928	965	1000	1034	1070	1140	1212	1250

Width		Back	Base		Mechanism					
1 - 2 \$0	3 \$145	L 0\$	ZN - VN \$0	ZC - VC \$145	10 - 11 - 20 - 21 0\$	31 \$25	41 - 51 \$50	71 \$105	76F \$155	
Options			Arms				Legs			
R \$30	S \$75	F \$105	NA \$0	AS - AD - AW - AG - AR - AP - FT - FG - FD \$125				AX - AY \$200	AZ - FZ \$255	H - S - G \$0

How to Order

										Combination of Colors							
										Fabrics See the fabric chart Logiflex grade							
LC-	TX	-	L	WW	-												
serie	Width		Back	Structure		Base	Mechanism	Option		Arms		Legs	supplier	pattern	color		
Example	LC-	TX	1	-	L	WW	-	ZN	10	R	-	NA	-	H	ENNIS	LOFT	AQUA

Task Seating

Texto - Chair - Medium back

TEXTO

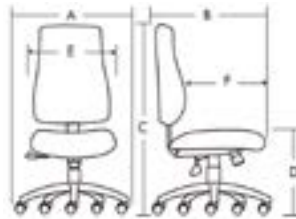
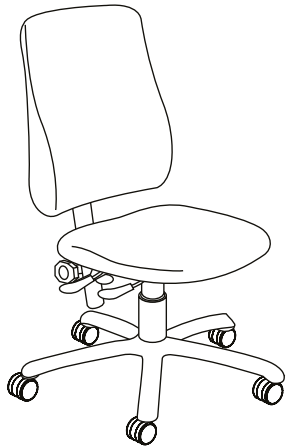

A Chair width	26"
B Chair depth	24"
C Chair height	38" - 43"
D Seat height	17" - 22"
E Backrest width	19"
F Seat depth	18"

Manufacturing Standards

Texto chair:

- Medium back following the curve of the back;
- Upholstered seat;
- Choice of black nylon or aluminum base with casters;
- Choice of mechanism;
- Choice of adjustable or fixed arms;
- 40 lbs weight and 10ft³ volume.

Mechanism 76F: Only with option F.

Options: Back height adjustment (R), seat sliding (S).

Fabric finishes: Selection of fabrics or vinyl by the customer from the supplier of their choice.

Number of yards for COM fabric:

Code	Total
TEXTO	1,5

Options

Chair options



See [Appendix F](#) for complete options

Prices

Code	GRA	GR1	COM	GR2	GR3	GR4	GR5	GR6	GR7	GR8	GR9	GR10	GR11	GR12	Cuir Leather
TX	761	797	830	863	903	945	987	1029	1072	1113	1155	1239	1322	1317	

Width		Back	Base		Mechanism				Arms		Legs
1 - 2 \$0	3 \$145	M 0\$	ZN - VN \$0	ZC - VC \$145	10 - 11 - 20 - 21 0\$	31 \$25	41 - 51 \$50	71 \$105	76F \$155		
Options					Arms						
R \$30	S \$75	F \$105			NA \$0	AS - AD - AW - AG - AR - AP - FT - FG - FD \$125	AX - AY \$200	AZ - FZ \$255	H - S - G \$0		

How to Order

										Combination of Colors							
										Fabrics <i>See the fabric chart Logiflex grade</i>							
LC-	TX	-	M	WW	-						supplier	pattern	color				
serie	Width	Back	Structure	Base	Mechanism	Option	Arms	Legs									
1 2 3																	
Example	LC-	TX	1	-	M	WW	-	ZN	10	R	-	NA	-	H	ENNIS	LOFT	AQUA

Task Seating

Texto - Chair - Director back

TEXTO

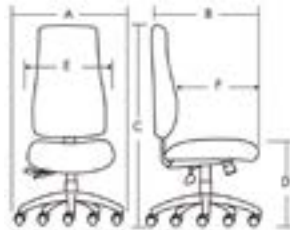
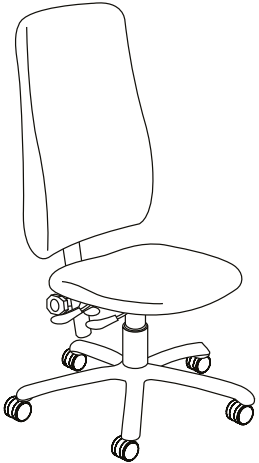

A Chair width	26"
B Chair depth	24"
C Chair height	42" - 47"
D Seat height	17" - 22"
E Backrest width	19"
F Seat depth	18"

Manufacturing Standards

Texto chair:

- Director back following the curve of the back;
- Upholstered seat;
- Choice of black nylon or aluminum base with casters;
- Choice of mechanism;
- Choice of adjustable or fixed arms;
- 45 lbs weight and 13,5ft³ volume.

Mechanism 76F: Only with option F.

Options: Back height adjustment (R), seat sliding (S).

Fabric finishes: Selection of fabrics or vinyl by the customer from the supplier of their choice.

Number of yards for COM fabric:

Code	Total
TEXTO	1,7

Options

Chair options



See [Appendix F](#) for complete options

Prices

Code	GRA	GR1	COM GR2	GR3	GR4	GR5	GR6	GR7	GR8	GR9	GR10	GR11	GR12	Cuir Leather
TX	832	870	910	950	1000	1049	1099	1151	1199	1251	1299	1399	1498	1457

Width		Back	Base		Mechanism				Arms		Legs
1 - 2 \$0	3 \$145	D 0\$	ZN - VN \$0	ZC - VC \$145	10 - 11 - 20 - 21 0\$	31 \$25	41 - 51 \$50	71 \$105	76F \$155		
Options					Arms						
R \$30	S \$75	F \$105			NA \$0	AS - AD - AW - AG - AR - AP - FT - FG - FD \$125	AX - AY \$200	AZ - FZ \$255	H - S - G \$0		

How to Order

LC-	TX	-	D	WW	-												
serie	Width	Back	Structure	Base	Mechanism	Option	Arms	Legs	supplier	pattern	color	Combination of Colors					
1 2 3												Fabrics See the fabric chart Logiflex grade					

Example	LC-	TX	1	-	D	WW	-	ZN	10	R	-	NA	-	H	ENNIS	LOFT	AQUA
----------------	-----	----	---	---	---	----	---	----	----	---	---	----	---	---	-------	------	------

Task Seating

Texto - Chair - High back with headrest

TEXTO

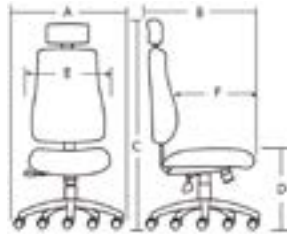
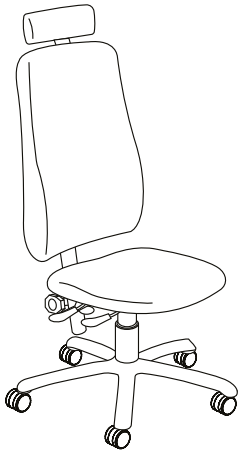

A Chair width	26"
B Chair depth	24"
C Chair height	49" - 54"
D Seat height	17" - 22"
E Backrest width	19"
F Seat depth	18"

Manufacturing Standards

Texto chair:

- High back with headrest following the curve of the back;
- Upholstered seat;
- Choice of black nylon or aluminum base with casters;
- Choice of mechanism;
- Choice of adjustable or fixed arms;
- 50 lbs weight and 13,5ft³ volume.

Mechanism 76F: Only with option F.

Options: Back height adjustment (R), seat sliding (S).

Fabric finishes: Selection of fabrics or vinyl by the customer from the supplier of their choice.

Number of yards for COM fabric:

Code	Total
TEXTO	1,7

Options

Chair options



See [Appendix F](#) for complete options

Prices

Code	GRA	GR1	COM GR2	GR3	GR4	GR5	GR6	GR7	GR8	GR9	GR10	GR11	GR12	Cuir Leather
TX	926	966	1005	1045	1095	1145	1194	1245	1295	1345	1394	1494	1593	1552

Width		Back	Base		Mechanism				Arms		Legs						
1 - 2 \$0	3 \$145	H 0\$	ZN - VN \$0	ZC - VC \$145	10 - 11 - 20 - 21 0\$	31 \$25	41 - 51 \$50	71 \$105	76F \$155	R \$30	S \$75	F \$105	NA \$0	AS - AD - AW - AG - AR - AP - FT - FG - FD \$125	AX - AY \$200	AZ - FZ \$255	H - S - G \$0

How to Order

LC-	TX	-	H	WW	-												
serie	Width		Back	Structure		Base	Mechanism	Option		Arms		Legs	supplier	pattern	color		
1	2	3				ZN	10, 11	F		NA, AS, AD, AW, AG, AR, AP, FT, FG, FS, FD, AX, AY, AZ, FZ		H					
						VN	20, 21	R				S					
						ZC	31, 41, 45	S				G					
						VC	71, 76F										
Example	LC-	TX	1	-	H	WW	-	ZN	10	R	-	NA	-	H	ENNIS	LOFT	AQUA

Task Seating

Texto - Stool - Low back

TEXTO

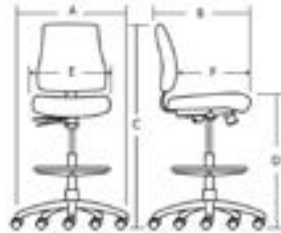
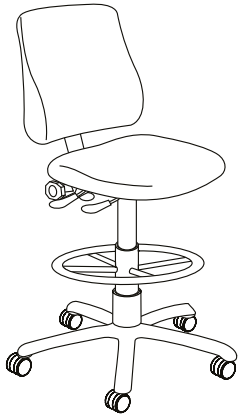

A Chair width	26"
B Chair depth	24"
C Chair height	40" - 50"
D Seat height	23" - 33"
E Backrest width	19"
F Seat depth	18"

Manufacturing Standards

Texto chair (stool):

- Low back following the curve of the back;
- Upholstered seat;
- Choice of black nylon or polished aluminum stool base with casters;
- Choice of mechanism;
- Choice of adjustable or fixed arms;
- 55 lbs weight and 10ft³ volume.

Option: Back height adjustment (R).

Fabric finishes: Selection of fabrics or vinyl by the customer from the supplier of their choice.

Number of yards for COM fabric:

Code	Total
TEXTO	1,3

Options

Chair options



See [Appendix F](#) for complete options

Prices

Code	GRA	GR1	COM	GR2	GR3	GR4	GR5	GR6	GR7	GR8	GR9	GR10	GR11	GR12	Cuir Leather
TX	902	929	958	986	1022	1056	1092	1128	1163	1198	1234	1304	1374	1413	

Width	Back	Base	Mechanism	Options
1 - 2 \$0	L \$0	TN \$0 TC \$145	11 \$0 31 \$25 51 \$50	R \$30
NA \$0	AS - AD - AW - AG - AR - AP - FT - FG - FD \$125		AX - AY \$200 AZ - FZ \$255	H - S - G - M \$0

How to Order

Combination of Colors																	
Fabrics See the fabric chart Logiflex grade																	
LC-	TX	1 2	-	L	WW	-	TN TC	11, 31, 51	R	-	NA AS, AS, AD, AW, AG, AR, AP, FT, FG, FS, FD, AX, AY, AZ, FZ	-	H S G M	supplier	pattern	color	
Example	LC-	TX	1	-	L	WW	-	TN	11	R	-	NA	-	H	ENNIS	LOFT	AQUA

Task Seating

Texto - Stool - Medium back

TEXTO

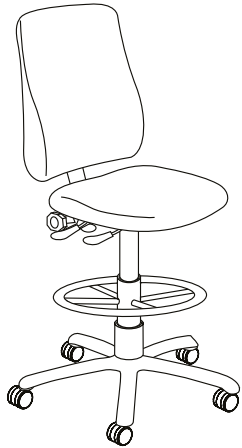

A Chair width	26"
B Chair depth	24"
C Chair height	44" - 54"
D Seat height	23" - 33"
E Backrest width	19"
F Seat depth	18"

Manufacturing Standards

Texto chair (stool):

- Medium back following the curve of the back;
- Upholstered seat;
- Choice of black nylon or polished aluminum stool base with casters;
- Choice of mechanism;
- Choice of adjustable or fixed arms;
- 55 lbs weight and 10ft³ volume.

Option: Back height adjustment (R).

Fabric finishes: Selection of fabrics or vinyl by the customer from the supplier of their choice.

Number of yards for COM fabric:

Code	Total
TEXTO	1,5

Options

Chair options



See [Appendix F](#) for complete options

Prices

Code	GRA	GR1	COM	GR2	GR3	GR4	GR5	GR6	GR7	GR8	GR9	GR10	GR11	GR12	Cuir Leather
TX	925	960	993	1026	1068	1111	1152	1194	1236	1276	1319	1403	1486	1481	

Width	Back	Base		Mechanism			Options
1 - 2	M	TN	TC	11	31	51	R
\$0	\$0	\$0	\$145	\$0	\$25	\$50	\$30
Arms							
NA	AS - AD - AW - AG - AR - AP - FT - FG - FD			AX - AY	AZ - FZ	Legs	
\$0	\$125			\$200	\$255	H - S - G - M	

How to Order

										<div style="border: 1px solid gray; padding: 5px; display: inline-block;"> Combination of Colors Fabrics See the fabric chart Logiflex grade </div>				
LC-	TX	1	-	M	WW	-	TN	11, 31, 51	R	NA, AS, AD, AW, AG, AR, AP, FT, FG, FS, FD, AX, AY, AZ, FZ	H S G M			
serie	Width	Back	Structure	Base	Mechanism	Option	Arms	Legs	supplier	pattern	color			

Example	LC-	TX	1	-	M	WW	-	TN	11	R	-	NA	-	H	ENNIS	LOFT	AQUA
----------------	-----	----	---	---	---	----	---	----	----	---	---	----	---	---	-------	------	------

Task Seating

Texto - Visitor chair with sled base - Low back

TEXTO

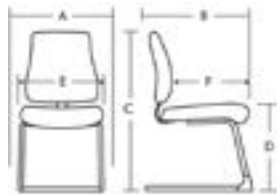
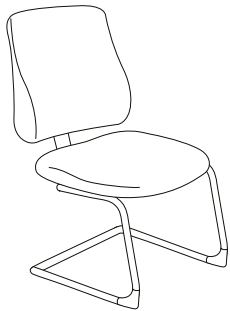

A Chair width	23"
B Chair depth	24"
C Chair height	35"
D Seat height	18"
E Backrest width	19"
F Seat depth	18"

Manufacturing Standards

Texto chair:

- Low back following the curve of the back;
- Upholstered seat;
- Sled base;
- Choice of adjustable or fixed arms;
- 40 lbs weight and 10ft³ volume.

Fabric finishes: Selection of fabrics or vinyl by the customer from the supplier of their choice.

Number of yards for COM fabric:

Code	Total
TEXTO	1,3

Options

Chair options



See [Appendix F](#) for complete options

Prices

Code	GRA	GR1	COM GR2	GR3	GR4	GR5	GR6	GR7	GR8	GR9	GR10	GR11	GR12	Cuir Leather
TX2	701	729	758	786	821	856	890	928	964	998	1033	1104	1175	1335

Back

L
\$0

Arms

NA
\$0

AS - AD - AR - AP - FT - FG - FD
\$125

AZ - FZ
\$255

How to Order

Combination of Colors

NA, AS, AD,
AR, AP, FT,
FG, FD, AZ,
FZ

Fabrics
See the fabric chart
Logiflex grade

LC-	TX2	-	L	WW	-	01	-	-	-	N			
serie	back	Structure	Sled base	Arms	Legs	supplier	pattern	color					

Example LC- TX2 - L WW - 01 - NA - N ENNIS LOFT AQUA

Task Seating

Texto - Visitor chair with sled base - Medium back

TEXTO

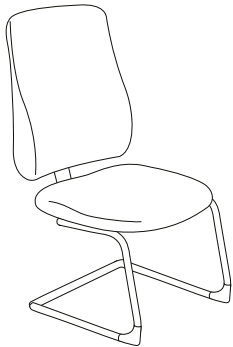

A Chair width	23"
B Chair depth	24"
C Chair height	39"
D Seat height	18"
E Backrest width	19"
F Seat depth	18"

Manufacturing Standards

Texto chair:

- Medium back following the curve of the back;
- Upholstered seat;
- Sled base;
- Choice of adjustable or fixed arms;
- 40 lbs weight and 10ft³ volume.

Fabric finishes: Selection of fabrics or vinyl by the customer from the supplier of their choice.

Number of yards for COM fabric:

Code	Total
TEXTO	1,5

Options

Chair options



See [Appendix F](#) for complete options

Prices

Code	GRA	GR1	COM GR2	GR3	GR4	GR5	GR6	GR7	GR8	GR9	GR10	GR11	GR12	Cuir Leather
TX2	726	759	792	826	868	910	952	993	1034	1076	1118	1202	1286	1402

Back

M
\$0

Arms

NA
\$0

AS - AD - AR - AP - FT - FG - FD
\$125

AZ - FZ
\$255

How to Order

Combination of Colors

NA, AS, AD,
AR, AP, FT,
FG, FD, AZ,
FZ

Fabrics
See the fabric chart
Logiflex grade

LC-	TX2	-	M	WW	-	01	-	-	-	N			
serie	back	Structure	Sled base	Arms	Legs	supplier	pattern	color					

Example

LC-	TX2	-	M	WW	-	01	-	NA	-	N	ENNIS	LOFT	AQUA
-----	-----	---	---	----	---	----	---	----	---	---	-------	------	------

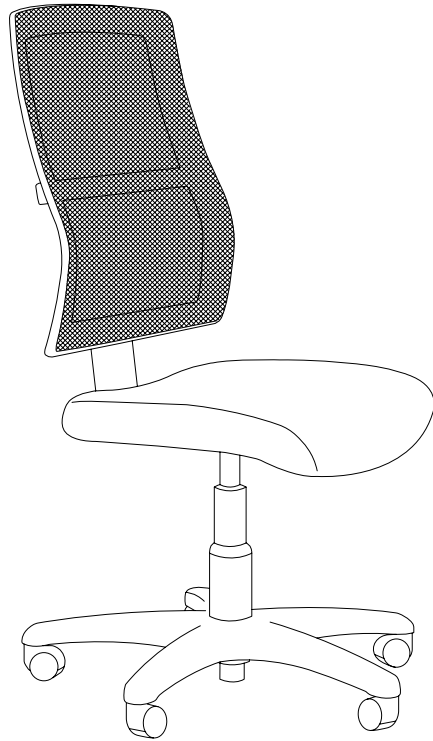

Texto Mesh Task Seating

With fabric mesh backrest and adjustable lumbar support, the Texto Mesh is the perfect office chair.

Task Seating

Appendix - TEXTO MESH - Options

Chair width



2 Standard seat



3 Large seat (+2")
\$145

Chair base



VN Black nylon tapered base



ZN Black nylon rounded base



VC Aluminium tapered base
\$145



ZC Aluminium rounded base
\$145

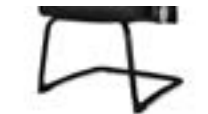

01 Sled base



TN Aluminium rounded
stool base



TC Aluminium rounded
stool base
\$145

Mechanisms

Mecanism 10 - 11 - 20 - 21

Mecanism 31
\$25

Mecanism 41 - 51
\$50

Mecanism 71
\$105

Options

S Seat sliding option
\$75

R Back height
Adjustment option
\$30

F Combined options
\$105

Task Seating

Appendix - TEXTO MESH - Options

Arms



NA
• No arm



AD Adjustable arms
\$125



AS Adjustable arms
\$125



FD Closed fixed arms
\$125



FG Open fixed arms
\$125



FT Bras fixes courbés ouverts
\$125



AZ Adjustable arms with multi-axis
and pivot armrests
\$255



FZ Fixed arms
\$255



AG Adjustable arms
\$125



AP Adjustable arms
\$125



AR Adjustable arms
\$125



AW Adjustable arms with pivot
\$125



AX Adjustable arms with multi-axis
armrests
\$200



AY Adjustable arms with multi-axis
and pivot armrests
\$200

Legs



H Casters for carpeting



S Casters for hand surfaces



G Nylon glides



M Mixed (3 casters, 2 glides)

Mesh Fabrics



MA06 Aero Mesh Black
PMS Black 6 C (#101820)



MA16 Graphite
PMS Cool Gray 9 C (#75787B)



MA26 Aluminium
PMS #7537 C



MA60 Sangria
PMS #2041 C

Task Seating

Texto Mesh - Chair - Medium Back

TXM2

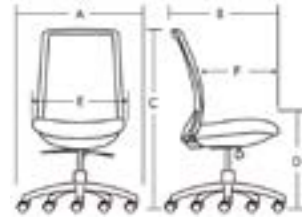
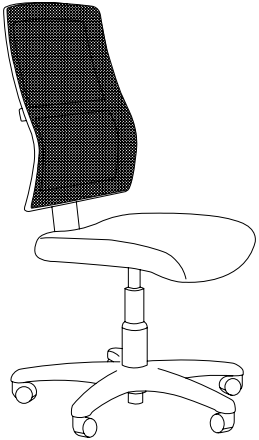

A Chair width	26"
B Chair depth	24"
C Chair height	39" - 44"
D Seat height	17" - 22"
E Backrest width	19"
F Seat depth	18"

Manufacturing Standards

Texto Mesh chair:

- Medium back following the curve of the back;
- Upholstered seat;
- Choice of black nylon or aluminum base with casters;
- Choice of mechanism;
- Choice of adjustable or fixed arms;
- 40 lbs weight and 10ft³ volume.

Options: Back height adjustment (R), seat sliding (S).

Fabric finishes: Selection of fabrics or vinyl by the customer from the supplier of their choice.

Number of yards for COM fabric:

Code	Total
TEXTO	0,9

Options

Chair options



See [Appendix F](#) for complete options

Prices

Code	GRA	GR1	COM	GR2	GR3	GR4	GR5	GR6	GR7	GR8	GR9	GR10	GR11	GR12	Cuir Leather
TXM	759	781	803	825	852	879	906	933	962	988	1015	1071	1126	998	

Width

2

\$0

3

\$145

Base

ZN - VN

\$0

ZC - VC

\$145

Mechanism

10 - 11 - 20 - 21

\$0

31

\$25

41 - 51

\$50

71

\$105

Options

R

\$30

S

\$75

F

\$105

Arms

NA

\$0

AS - AD - AW - AG - AR - AP - FT - FG - FD

\$125

AX - AY

\$200

AZ - FZ

\$255

Legs

H - S - G

\$0

How to Order

LC-	TXM			MWE														
serie	width			High + Structure		Base	Mechanism	Option	arms	legs	supplier	pattern	color		Mesh fabric			
2	3					ZN VN ZC	10, 11 20, 21 31, 41, 51, 71	F R S	NA, AS, AD, AW, AG, AR, AP, FT, FG, FD, AX, AY, AZ, FZ	H S G					MA06 MA16 MA26 MA60			
Example	LC-	TXM	2	-	MWE	-	ZN	10	R	-	NA	-	H	ENNIS	LOFT	AQUA	-	MA06

Task Seating

Texto Mesh - Stool - Medium back

TXM2

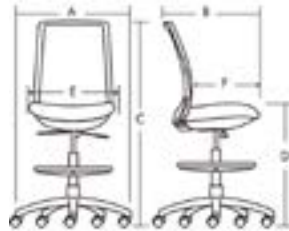
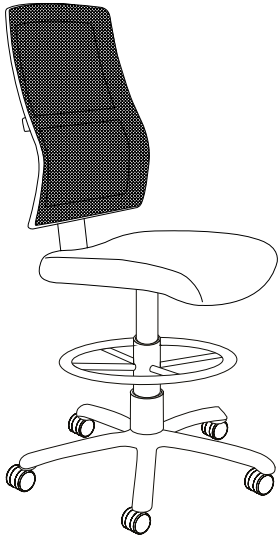

A Chair width	26"
B Chair depth	24"
C Chair height	45" - 55"
D Seat height	23" - 33"
E Backrest width	19"
F Seat depth	18"

Manufacturing Standards

Texto Mesh chair (stool):

- Medium back following the curve of the back;
- Upholstered seat;
- Choice of black nylon or polished aluminum stool base with casters;
- Choice of mechanism;
- Choice of adjustable or fixed arms;
- 55 lbs weight and 10ft³ volume.

Option: Back height adjustment (R).

Fabric finishes: Selection of fabrics or vinyl by the customer from the supplier of their choice.

Number of yards for COM fabric:

Code	Total
TEXTO	0,9

Options

Chair options



See [Appendix F](#) for complete options

Prices

Code	GRA	GR1	COM	GR2	GR3	GR4	GR5	GR6	GR7	GR8	GR9	GR10	GR11	GR12	Cuir Leather
TXM2	923	945	966	988	1015	1044	1071	1097	1126	1151	1180	1234	1289	1162	

Base

TN	TC
\$0	\$145

Mechanism

11	31	51
\$0	\$25	\$50

Options

R
\$30

Arms

NA	AS - AD - AW - AG - AR - AP - FT - FG - FD
\$0	\$125

AX - AY
\$200

AZ - FZ
\$255

Legs

H - S - G - M
\$0

How to Order

										Combination of Colors							
										Fabrics <i>See the fabric chart Logiflex grade</i>							
LC-	TXM2	-	MWE	-	TN	11, 31, 51	R	NA, AS, AD, AW, AG, AR, AP, FT, FG, FD, AX, AY, AZ, FZ	H S G M	ENNIS	LOFT	AQUA	MA06 MA16 MA26 MA60				
serie	High + Structure	Base	Mechanism	Option	arms	legs	supplier	pattern	color	Mesh fabric							
Example	LC-	TXM2	-	MWE	-	TN	11	R	-	NA	-	H	ENNIS	LOFT	AQUA	-	MA06

Task Seating

Texto Mesh - Visitor chair with sled base - Medium back

TXM2

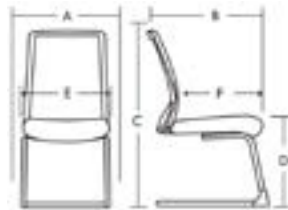
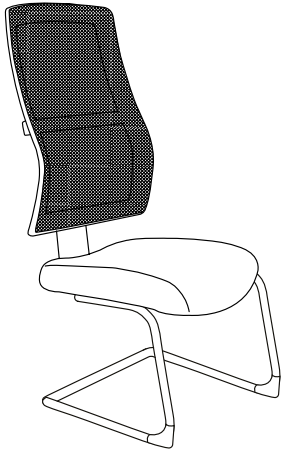

A Chair width	23"
B Chair depth	24"
C Chair height	40"
D Seat height	18"
E Backrest width	19"
F Seat depth	18"

Manufacturing Standards

Texto Mesh chair:

- Medium back following the curve of the back;
- Upholstered seat;
- Sled base;
- Choice of adjustable or fixed arms;
- 40 lbs weight and 10ft³ volume.

Fabric finishes: Selection of fabrics or vinyl by the customer from the supplier of their choice.

Number of yards for COM fabric:

Code	Total
TEXTO	0,9

Options

Chair options



See [Appendix F](#) for complete options

Prices

Code	GRA	GR1	COM	GR2	GR3	GR4	GR5	GR6	GR7	GR8	GR9	GR10	GR11	GR12	Cuir Leather
TXM2	722	744	767	788	816	842	870	898	925	951	981	1033	1089	962	

Arms

NA	AS - AD - AR - AP - FT - FG - FD	AZ - FZ
\$0	\$125	\$255

How to Order

Combination of Colors

NA, AS, AD,
AR, AP, FT,
FG, FD, AZ,
FZ

Fabrics
See the fabric chart
Logiflex grade

MA06
MA16
MA26
MA60

LC-	TXM2	-	MWE	-	01	-	N								
	serie		High + Structure		sled base		arms		legs	supplier	pattern	color		Mesh fabric	

Example LC- TXM2 - MWE - 01 - NA - N ENNIS LOFT AQUA - MA06

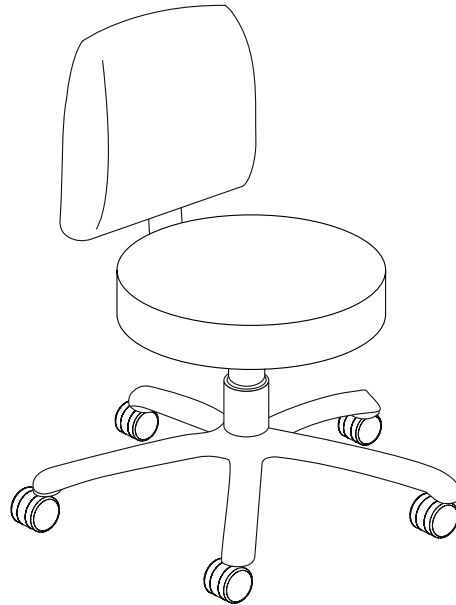

Texto Lab Laboratory Seating

A round seat and different backrest options make the Texto Lab a versatile chair that doesn't take up much space. It can easily be tucked under a counter, and a stool version is available with a footrest.



Appendix - TEXTO LAB - Options

Chair back



X No back

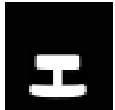

T T-shaped back



C Contour back



L Low back

Chair base



ZN Black nylon rounded base



ZC Aluminium rounded base
\$145



TN Aluminium rounded stool base



TC Aluminium rounded stool base
\$145

Mechanisms

Mecanism 11

Mecanism 31
\$25

Mecanism 51
\$50

Option

R Back height Adjustment option
\$30

Legs



H Casters for carpeting



S Casters for hand surfaces



G Nylon glides



M Mixed (3 casters, 2 glides)

Task Seating

Texto Lab - Chair - No back

TXR

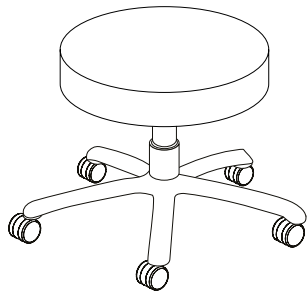

A Chair width	26"
B Chair depth	17,5"
C Chair high (cyl.24)	15,5" - 20,5"
C Chair high (cyl.30)	17" - 24,5"

Manufacturing Standards

Texto Lab chair:

- No back;
- Upholstered seat;
- Choice of black nylon or aluminum base with casters;
- Choice of cylinder;
- 20 lbs weight and 6ft³ volume.

Fabric finishes: Selection of fabrics or vinyl by the customer from the supplier of their choice.

Number of yards for COM fabric:

Code	Total
TEXTO	0,7

Options

Chair options



See [Appendix F](#) for complete options

Prices

Code	GRA	GR1	COM GR2	GR3	GR4	GR5	GR6	GR7	GR8	GR9	GR10	GR11	GR12	Cuir Leather
TXR	446	463	480	497	517	539	560	580	601	623	643	685	727	729

Back

X

\$0

Base

ZN

\$0

ZC

\$145

Cylinder

24 - 30

\$0

Legs

H - S - G - M

\$0

How to Order

Combination of Colors

Fabrics

See the fabric chart
Logiflex grade

LC-	TXR	-	X	WW	-	ZN	18	13	-	NA	-	H	ENNIS	LOFT	AQUA
	serie		back	Structure		Base	Cylinder	Mechanism		arms		legs	supplier	pattern	color

Example

LC-	TXR	-	X	WW	-	ZN	18	13	-	NA	-	H	ENNIS	LOFT	AQUA
-----	-----	---	---	----	---	----	----	----	---	----	---	---	-------	------	------

Task Seating

Texto Lab - Chair - T-shaped back

TXR

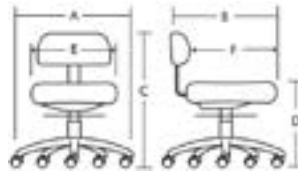
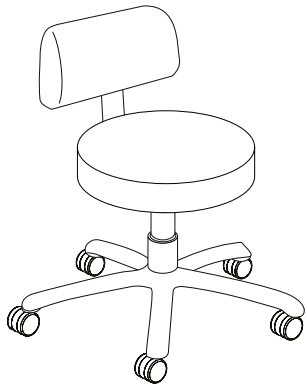

A Chair width	26"
B Chair depth	21"
C Chair high (cyl.24)	25,5" - 30,5"
C Chair high (cyl.30)	27" - 34,5"
D Seat height (cyl.24)	15,5" - 20,5"
D Seat height (cyl.30)	17" - 24,5"
E Back width	17,5"
F Seat depth	17,5"

Manufacturing Standards

- Texto Lab chair:
- T-shaped back;
 - Upholstered seat;
 - Choice of black nylon or aluminum base with casters;
 - Choice of cylinder;
 - 20 lbs weight and 6ft³ volume.

Fabric finishes: Selection of fabrics or vinyl by the customer from the supplier of their choice.

Number of yards for COM fabric:

Code	Total
TEXTO	0,7

Options

Chair options

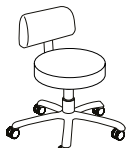

See [Appendix F](#) for complete options

Prices

Code	GRA	GR1	COM GR2	GR3	GR4	GR5	GR6	GR7	GR8	GR9	GR10	GR11	GR12	Cuir Leather
TXR	531	548	565	581	602	624	644	665	686	707	728	770	812	814

Back	Base	Cylinder	Legs
T \$0	ZN \$0 ZC \$145	24 - 30 \$0	H - S - G - M \$0

How to Order

Combination of Colors

Fabrics
See the fabric chart
Logiflex grade

LC-	TXR	-	T	WW	-	ZN	18	13	-	NA	-	H	ENNIS	LOFT	AQUA
	serie		back	Structure		Base	Cylinder	Mechanism		arms		legs	supplier	pattern	color

Example LC- TXR - T WW - ZN 18 13 - NA - H ENNIS LOFT AQUA

Task Seating

Texto Lab - Chair - Contour back

TXR

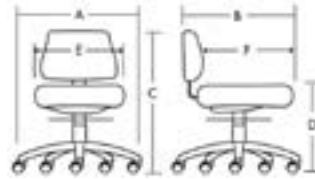
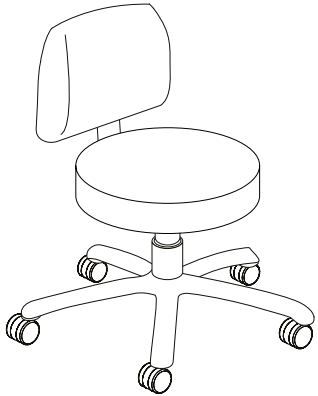

A Chair width	26"
B Chair depth	21"
C Chair high (cyl.24)	26,5" - 31,5"
C Chair high (cyl.30)	28" - 35,5"
D Seat height (cyl.24)	16,5" - 21,5"
D Seat height (cyl.30)	18" - 25,5"
E Back width	17,5"
F Seat depth	17,5"

Manufacturing Standards

Texto Lab chair:

- Contour back;
- Upholstered seat;
- Choice of black nylon or aluminum base with casters;
- Choice of cylinder;
- Choice of mechanism;
- 30 lbs weight and 10ft³ volume.

Option: Back height adjustment (R).

Fabric finishes: Selection of fabrics or vinyl by the customer from the supplier of their choice.

Number of yards for COM fabric:

Code	Total
TEXTO	0,95

Options

Chair options



See [Appendix F](#) for complete options

Prices

Code	GRA	GR1	COM GR2	GR3	GR4	GR5	GR6	GR7	GR8	GR9	GR10	GR11	GR12	Cuir Leather
TXR	622	644	667	690	720	749	777	807	836	864	894	951	1010	1020

Back	Base	Cylinder	Mechanism	Option	Legs
C	ZN ZC	18 - 24	11 31 51	R	H - S - G - M
\$0	\$0 \$145	\$0	\$0 \$25 \$50	\$30	\$0

How to Order

													Combination of Colors				
													Fabrics <i>See the fabric chart Logiflex grade</i>				
LC-	TXR	-	C	WW	-	ZN ZC	18 24	11, 31, 51	R	-	NA	-	H S G M				
serie			back	Structure		Base	Cylinder	Mechanism	Option		Arms		Legs	supplier	pattern	color	
Exemple	LC-	TXR	-	C	WW	-	ZN	18	11	R	-	NA	-	H	ENNIS	LOFT	AQUA

Task Seating

Texto Lab - Chair - Low back

TXR

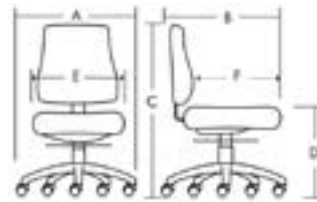
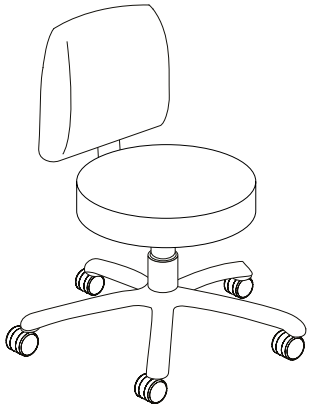

A Chair width	26"
B Chair depth	24"
C Chair high (cyl.24)	33,5" - 38,5"
C Chair high (cyl.30)	35" - 42,5"
D Seat height (cyl.24)	16,5" - 21,5"
D Seat height (cyl.30)	18" - 25,5"
E Back width	17,5"
F Seat depth	17,5"

Manufacturing Standards

Texto Lab chair:

- Low back following the curve of the back;
- Upholstered seat;
- Choice of black nylon or aluminum base with casters;
- Choice of cylinder;
- Choice of mechanism;
- 40 lbs weight and 10ft³ volume.

Option: Back height adjustment (R).

Fabric finishes: Selection of fabrics or vinyl by the customer from the supplier of their choice.

Number of yards for COM fabric:

Code	Total
TEXTO	1,3

Options

Chair options

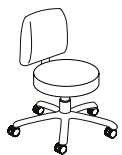

See [Appendix F](#) for complete options

Prices

Code	GRA	GR1	COM GR2	GR3	GR4	GR5	GR6	GR7	GR8	GR9	GR10	GR11	GR12	Cuir Leather
TXR	707	740	772	803	844	884	925	965	1005	1045	1085	1167	1246	1283

Back	Base	Cylinder	Mechanism	Option	Legs
L	ZN ZC	18 - 24	11 31 51	R	H - S - G - M
\$0	\$0 \$145	\$0	\$0 \$25 \$50	\$30	\$0

How to Order

													Combination of Colors				
													Fabrics <i>See the fabric chart Logiflex grade</i>				
LC-	TXR	-	L	WW	-	ZN ZC	18 24	11, 31, 51	R	-	NA	-	H S G M				
serie	back		Structure			Base	Cylinder	Mechanism	Option		Arms		Legs	supplier	pattern	color	
Example	LC-	TXR	-	L	WW	-	ZN	18	11	R	-	NA	-	H	ENNIS	LOFT	AQUA

Task Seating

Texto Lab - Stool - No back

TXR

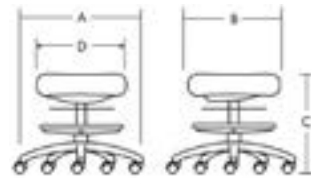
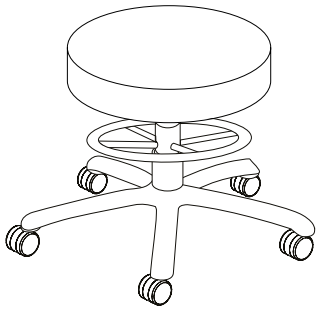

A Chair width	26"
B Chair depth	17,5"
C Chair high (cyl.24)	17" - 24,5"
C Chair high (cyl.30)	22" - 32"
D Back width	17,5"

Manufacturing Standards

Texto Lab chair (stool):

- No back;
- Upholstered seat;
- Choice of black nylon or polished aluminum stool base with casters;
- Choice of cylinder;
- 30 lbs weight and 6ft³ volume.

Fabric finishes: Selection of fabrics or vinyl by the customer from the supplier of their choice.

Number of yards for COM fabric:

Code	Total
TEXTO	0,7

Options

Chair options

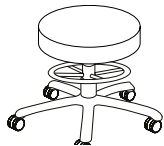

See [Appendix F](#) for complete options

Prices

Code	GRA	GR1	COM GR2	GR3	GR4	GR5	GR6	GR7	GR8	GR9	GR10	GR11	GR12	Cuir Leather
TXR	610	627	643	660	681	702	723	744	764	786	807	847	890	894

Back

X

\$0

Base

TN

\$0

TC

\$145

Cylinder

24 - 30

\$0

Legs

H - S - G - M

\$0

How to Order

Combination of Colors

Fabrics

See the [fabric chart](#)
Logiflex grade

LC-	TXR	-	X	WW	-	TN	24	13	-	NA	-	H	ENNIS	LOFT	AQUA
	serie		back	Structure		Base	Cylinder	Mechanism		Arms		Legs	supplier	pattern	color

Example

LC-	TXR	-	X	WW	-	TN	24	13	-	NA	-	H	ENNIS	LOFT	AQUA
-----	-----	---	---	----	---	----	----	----	---	----	---	---	-------	------	------

Task Seating

Texto Lab - Stool - T-shaped back

TXR

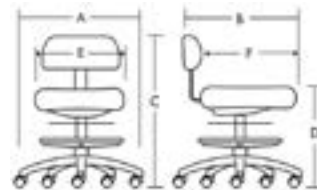
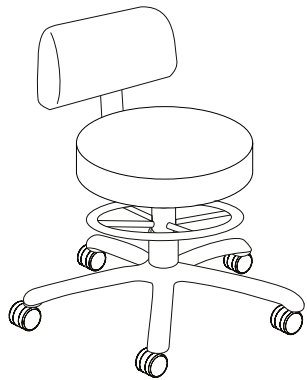

A Chair width	26"
B Chair depth	21"
C Chair high (cyl.24)	27" - 34,5"
C Chair high (cyl.30)	32" - 42"
D Seat height (cyl.24)	17" - 24,5"
D Seat height (cyl.30)	22" - 32"
E Back width	17,5"
F Seat depth	17,5"

Manufacturing Standards

Texto Lab chair (stool):

- T-shaped back;
- Upholstered seat;
- Choice of black nylon or polished aluminum stool base with casters;
- Choice of cylinder;
- 40 lbs weight and 10ft³ volume.

Fabric finishes: Selection of fabrics or vinyl by the customer from the supplier of their choice.

Number of yards for COM fabric:

Code	Total
TEXTO	0,8

Options

Chair options

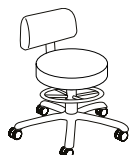

See [Appendix F](#) for complete options

Prices

Code	GRA	GR1	COM GR2	GR3	GR4	GR5	GR6	GR7	GR8	GR9	GR10	GR11	GR12	Cuir Leather
TXR	695	712	728	746	765	788	809	830	849	872	2979	932	974	977

Back

T

\$0

Base

TN

\$0

TC

\$145

Cylinder

24 - 30

\$0

Legs

H - S - G - M

\$0

How to Order

Combination of Colors

Fabrics

See the [fabric chart](#)
Logiflex grade

LC-	TXR	-	T	WW	-	TN	24	13	-	NA	-	H	S	G	M	supplier	pattern	color

Example

LC-	TXR	-	T	WW	-	TN	24	13	-	NA	-	H				ENNIS	LOFT	AQUA
-----	-----	---	---	----	---	----	----	----	---	----	---	---	--	--	--	-------	------	------

Task Seating

Texto Lab - Stool - Contour back

TXR

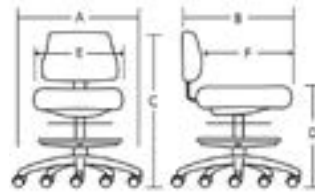
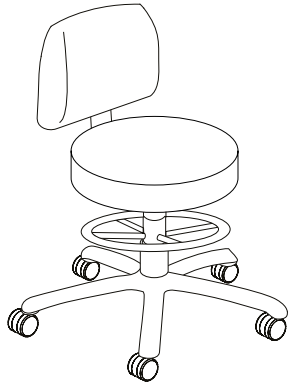

A Chair width	26"
B Chair depth	21"
C Chair high (cyl.24)	27" - 34,5"
C Chair high (cyl.30)	32" - 42"
D Seat height (cyl.24)	17" - 24,5"
D Seat height (cyl.30)	22" - 32"
E Back width	17,5"
F Seat depth	17,5"

Manufacturing Standards

Texto Lab chair (stool):

- Contour back;
- Upholstered seat;
- Choice of black nylon or polished aluminum stool base with casters;
- Choice of cylinder;
- Choice of mechanism;
- 30 lbs weight and 10ft³ volume.

Option: Back height adjustment (R).

Fabric finishes: Selection of fabrics or vinyl by the customer from the supplier of their choice.

Number of yards for COM fabric:

Code	Total
TEXTO	0,95

Options

Chair options

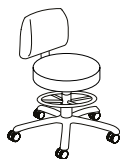

See [Appendix F](#) for complete options

Prices

Code	GRA	GR1	COM GR2	GR3	GR4	GR5	GR6	GR7	GR8	GR9	GR10	GR11	GR12	Cuir Leather
TXR	785	809	832	854	883	911	942	970	999	1028	1056	1115	1173	1184

Back	Base	Cylinder	Mechanism	Options	Legs
C	TN TC	24 - 30	11 31 51	R	H - S - G - M
\$0	\$0 \$145	\$0	\$0 \$25 \$50	\$30	\$0

How to Order

Combination of Colors																				
Fabrics See the fabric chart Logiflex grade																				
LC-	TXR	-	C	WW	-	TN	24	11, 31, 51	R	-	NA	-	H	S	G	M	supplier	pattern	color	
serie	back	Structure	Base	Cylinder	Mechanism	Option	Arms	Legs	supplier	pattern	color	supplier	pattern	color	supplier	pattern	color	supplier	pattern	color
Example	LC-	TXR	-	C	WW	-	TN	24	11	R	-	NA	-	H			ENNIS	LOFT	AQUA	

Task Seating

Texto Lab - Stool - Low back

TXR

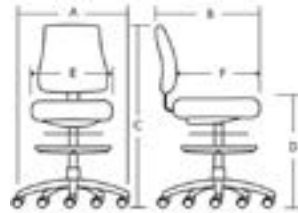
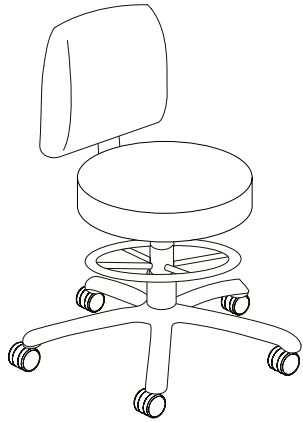

A Chair width	26"
B Chair depth	21"
C Chair high (cyl.24)	27" - 34,5"
C Chair high (cyl.30)	32" - 42"
D Seat height (cyl.24)	17" - 24,5"
D Seat height (cyl.30)	22" - 32"
E Back width	17,5"
F Seat depth	17,5"

Manufacturing Standards

Texto Lab chair (stool):

- Low back following the curve of the back;
- Upholstered seat;
- Choice of black nylon or polished aluminum stool base with casters;
- Choice of cylinder;
- Choice of mechanism;
- 30 lbs weight and 10ft³ volume.

Option: Back height adjustment (R).

Fabric finishes: Selection of fabrics or vinyl by the customer from the supplier of their choice.

Number of yards for COM fabric:

Code	Total
TEXTO	0,95

Options

Chair options

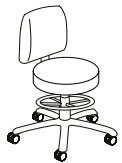

See [Appendix F](#) for complete options

Prices

Code	GRA	GR1	COM GR2	GR3	GR4	GR5	GR6	GR7	GR8	GR9	GR10	GR11	GR12	Cuir Leather
TXR	872	903	935	967	1008	1049	1088	1128	1169	1209	1248	1329	1410	1448

Back	Base	Cylinder	Mechanism	Options	Legs
L	TN TC	24 - 30	11 31 51	R	H - S - G - M
\$0	\$0 \$145	\$0	\$0 \$25 \$50	\$30	\$0

How to Order

													Combination of Colors				
													Fabrics <i>See the fabric chart Logiflex grade</i>				
LC-	TXR	-	L	WW	-	TN TC	24 30	11, 31, 51	R	-	NA	-	H S G M				
serie			back	Structure		Base	Cylinder	Mechanism	Option		Arms		Legs	supplier	pattern	color	
Example	LC-	TXR	-	L	WW	-	TN	24	11	R	-	NA	-	H	ENNIS	LOFT	AQUA

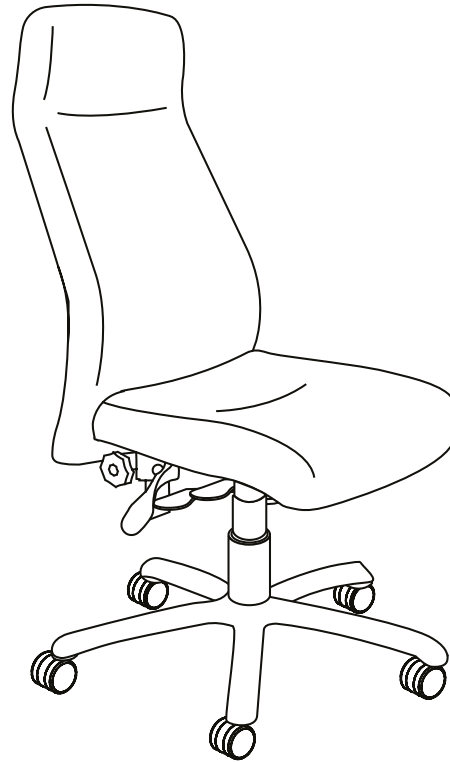

Elie Task Seating

The elegant and prestigious Elie Chair is the perfect choice for executives. The sled base option means that it can also be used for guests, and it fits perfectly with any decor.



Appendix - ELIE - Options

Chair backs



M Medium back



H High back

Chair bases



VN Black nylon tapered base



ZN Black nylon rounded base



VC Aluminium tapered base
\$145



ZC Aluminium rounded base
\$145



01 Sled base

Mechanism

Mechanism 10 - 11 - 20 - 21

Mechanism 31
\$25

Mechanism 41 - 51
\$50

Options

S Seat sliding option
\$75

Arms



NA
• No arms



AD Adjustable arms
\$125



AS Adjustable arms
\$125



FD Closed fixed arms
\$125



FG Open fixed arms
\$125



FT Open curved fixed arms
\$125



AZ Adjustable arms with multi-axis
and pivot armrests
\$255



FZ Fixed arms
\$255

Legs



H Casters for carpeting



S Casters for hard surfaces



G Nylon glides

Task Seating

Elie - Chair - Medium back

ELIE



A Chair width	26"
B Chair depth	24,5"
C Chair height	38,5" - 43,5"
D Seat height	17,5" - 22,5"
E Backrest width	19"
F Seat depth	19"

Manufacturing Standards

Elie chair:

- Medium back following the curve of the back;
- Upholstered seat;
- Choice of black nylon or aluminum base with casters;
- Choice of mechanism;
- Choice of adjustable or fixed arms;
- 45 lbs weight and 13,5ft³ volume.

Option: Seat sliding (S).

Fabric finishes: Selection of fabrics or vinyl by the customer from the supplier of their choice.

Number of yards for COM fabric:

Code	Total
ELIE	2.1

Options

Chair options



See [Appendix F](#) for complete options

Prices

Code	GRA	GR1	COM GR2	GR3	GR4	GR5	GR6	GR7	GR8	GR9	GR10	GR11	GR12	Cuir Leather
EE	994	1023	1063	1103	1152	1202	1251	1301	1350	1400	1450	1549	1647	1609

Back

M
\$0

Bases

ZN - VN
\$0

ZC - VC
\$145

Mechanisms

10 - 11 - 20 - 21
\$0

31
\$25

41 - 51
\$50

Options

S
\$75

Arms

NA
\$0

AS - AD - FT - FG - FD
\$125

AZ - FZ
\$255

Legs

H - S - G
\$0

How to Order

													Combination of Colors			
LC-	EE	-	M	WW	-	ZN VN VC	10, 11, 20, 21, 31, 41, 51	S	NA, AS, AD, FT, FG, FD, AZ, FZ	-	H S G	Fabrics <i>See the fabric chart Logiflex grade</i>				
	série		back	structure		base	Mechanism	option	arm		leg	supplier	pattern	color		
Example	LC-	EE	-	M	WW	-	ZN	11	S	-	NA	-	H	ENNIS	LOFT	AQUA

Task Seating

Elie - Chair - High back

ELIE

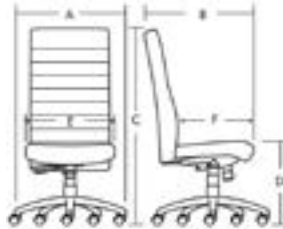
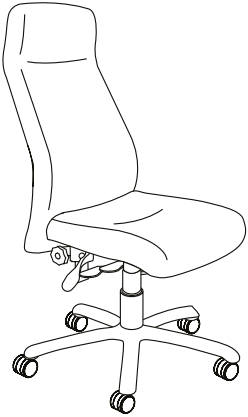

A Chair width	26"
B Chair depth	25"
C Chair height	47,5" - 52,5"
D Seat height	17,5" - 22,5"
E Backrest width	19"
F Seat depth	19"

Manufacturing Standards

Elie chair:

- High back following the curve of the back;
- Upholstered seat;
- Choice of black nylon or aluminum base with casters;
- Choice of mechanism;
- Choice of adjustable or fixed arms;
- 45 lbs weight and 13,5ft³ volume.

Option: Seat sliding (S).

Fabric finishes: Selection of fabrics or vinyl by the customer from the supplier of their choice.

Number of yards for COM fabric:

Code	Total
ELIE	2,3

Options

Chair options



See [Appendix F](#) for complete options

Prices

Code	GRA	GR1	COM GR2	GR3	GR4	GR5	GR6	GR7	GR8	GR9	GR10	GR11	GR12	Cuir Leather
EE	1176	1210	1256	1302	1358	1415	1472	1529	1586	1643	1699	1813	1927	1958

Back

H
\$0

Bases

ZN - VN \$0
ZC - VC \$145

Mechanisms

10 - 11 - 20 - 21 \$0
31 \$25
41 - 51 \$50

Options

S
\$75

Arms

NA \$0
AS - AD - FT - FG - FD \$125

Legs

AZ - FZ \$255
H - S - G \$0

How to Order

											Combination of Colors					
LC-	EE	-	H	WW	-	ZN VN VC	10, 11, 20, 21, 31, 41, 51	S	NA, AS, AD, FT, FG, FD, AZ, FZ	-	H S G	Fabrics <i>See the fabric chart Logiflex grade</i>				
	série		back	structure		base	Mechanism	option	arm		leg	supplier	pattern	color		
Example	LC-	EE	-	H	WW	-	ZN	11	S	-	NA	-	H	ENNIS	LOFT	AQUA

Task Seating

Elie - Visitor chair with sled base - Medium back

ELIE

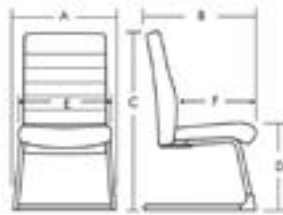

A Chair width	24"
B Chair depth	24,5"
C Chair height	39"
D Seat height	18"
E Backrest width	19"
F Seat depth	19"

Manufacturing Standards

- Elie chair:
- Medium back following the curve of the back;
 - Upholstered seat;
 - Sled base;
 - Choice of adjustable or fixed arms;
 - 45 lbs weight and 13,5ft³ volume.

Fabric finishes: Selection of fabrics or vinyl by the customer from the supplier of their choice.

Number of yards for COM fabric:

Code	Total
ELIE	2,1

Options

Chair options



See [Appendix F](#) for complete options

Prices

Code	GRA	GR1	COM GR2	GR3	GR4	GR5	GR6	GR7	GR8	GR9	GR10	GR11	GR12	Cuir Leather
EE	959	988	1028	1068	1117	1167	1216	1266	1315	1365	1415	1514	1612	1574

Arms

NA	AS - AD - FT - FG - FD	AZ - FZ
\$0	\$125	\$255

How to Order

Combination of Colors

LC-	EE	-	MWW	-	01	-	NA, AS, AD, FT, FG, FD, AZ, FZ	-	N			
	serie		height + structure		sled base		arms		legs	supplier	pattern	color

Fabrics
See the fabric chart
Logiflex grade

Example

LC-	EE	-	MWW	-	01	-	NA	-	N	ENNIS	LOFT	AQUA
-----	----	---	-----	---	----	---	----	---	---	-------	------	------

Accessories

SIT - Electrical Accessories

QIBL

Wireless Charger

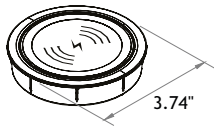

- Air charger wireless;
- Qi compatible device;
- 72" power cable with electric plug;
- Finish: Black.



Code	\$	Description
QIBL	617	

MH3C

Connectivity unit

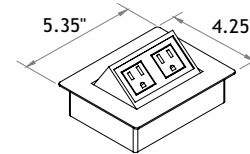

- Retractable connectivity unit with 2 electrical outlets;
- 72" or 120" power cable with electric plug;
- Finish: Satin Nickel.



Code	\$	Description
MH3C	397	Satin Nickel, 72" power cable
MH3C120	410	Satin Nickel, 120" power cable

QIRE

Qi Adapter

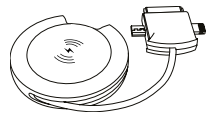

- Receiver to adapt devices not Qi compatible.
- Built-in connections for Apple 30 pin and lightning, Micro-USB.

Code	\$	Description
QIRE	170	

MH3D

Connectivity unit

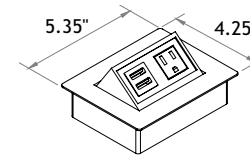

- Retractable connectivity unit with 1 electrical outlet and 2 USB (chargers);
- 72" or 120" power cable with electric plug;
- Finish: Satin Nickel.



Code	\$	Description
MH3DSN	397	Satin Nickel, 72" power cable
MH3DSN120	410	Satin Nickel, 120" power cable
MH3DBL	397	Black, 72" power cable
MH3DBL120	410	Black, 120" power cable
MH3DWH	397	White, 72" power cable
MH3DWH120	410	White, 120" power cable

QIIP

Transmitter for iPhone

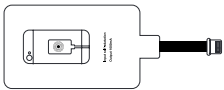

- Receiver for phones without Qi technology;
- For wireless charge devices;
- Adapter for Apple lightning port.

Code	\$	Description
QIIP	112	

As our product line is constantly evolving and expanding, we recommend that you visit logiflex.ca for updates.

logiflex

1235 St-Roch N., Sherbrooke QC J1N 0H2 Canada
T : 1.877.864.9323 | F : 1.800.474.7830 | logiflex.ca

May 22, 2023 | Canada

LOGIFLEX | SEATING

