

Collection Characteristics

The Core of the Product

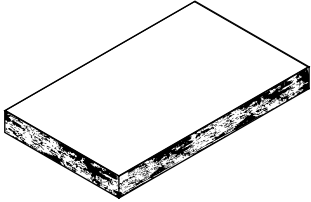

- Logiflex uses thermally fused laminate and high pressure laminate to build its case good products;
- Both high pressure laminate and thermally fused laminate products are constructed from a ANSI A208 Approved standards. Logiflex chooses to use Uniboard M-2 materials that have a density range of 630-710 kg/m³; a thickness tolerance of +/- 0.200mm to +/- 0.100mm for precision, screw holding face at a rate of 202 lbs, a core value of 180 lbs and an emissions record of less that 0.09 ppm.

Tops, Legs, Fronts and Backs

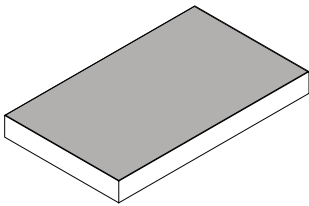

- All Manhattan tops are 1-5/8" thick thermally fused laminate or 1-9/16" high pressure laminate with 45-lb/cu ft density industrial grade composite wood core;
- Legs are 1" thick thermally fused laminate with 45-lb/cu ft density industrial grade composite wood core;
- Fronts and backs are 5/8" thick thermally fused laminate with 45-lb/cu ft density high density particle board.

Logiflex offers a wide selection of laminate colors available. Consult the complete [Color and Finishes Guide](#)

Edges

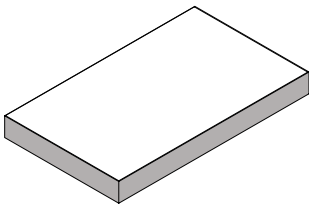

- Surfaces are finished with 1.5 mm heat sealed PVC edge banding in a choice of matching or complimentary colors;
- Non-showing surfaces are finished with 0.5 mm heat sealed PVC edge banding.

Wood Grain

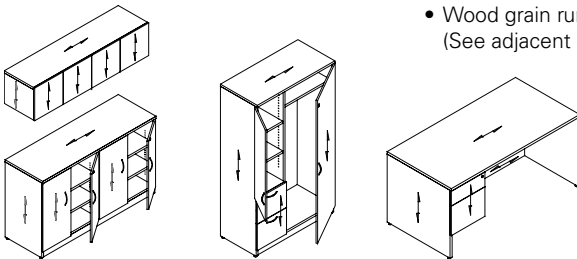

- Wood grain runs lengthwise on surfaces and vertically on drawers, doors and legs. (See adjacent images for wood grain direction placements).

Assembly

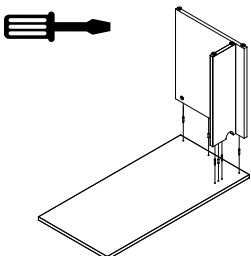

- All casegood products with the exception of empty desk shells and empty returns are delivered assembled;
- All tables with the exception of extended corner tables are delivered disassembled.

Gable Supports

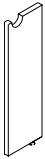

- Gables are 1" thick thermally fused laminate or high pressure laminate with 45-lb/cu ft density industrial grade composite wood core;
- Partial gables include a grommet for wire management;
- Gables come with a 1.5" levelling glides providing 1" of height adjustability to the desk.

Modesties

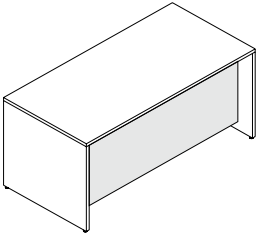

- Modesties are thermofused laminate (TFL) - 5/8" high-density particle board and include a 1.5 mm polyvinyl chloride (PVC) edge on showing surfaces and 0.5 mm polyvinyl chloride (PVC) on non-showing surfaces;
- Modesty standard is full height (FM);
- Modesties are also available in 2 other heights.

Glass Frames

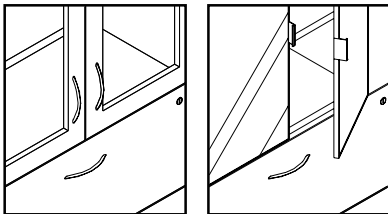

PV - Glass Doors

FL - Glass Doors

- Types of glass doors offered:
 - PV: 2" wide glass satin nickel aluminium frame doors with standard frosted glass (VS);
 - FL: thin frame 5/32" aluminum-frame doors with standard white glass (V4) and built-in handle available as an option;
- Glass is .157" thick;
- Acrylic is .125" thick.

Logiflex offers a wide selection of glass colors. Consult the complete [Color and Finishes Guide](#).

Lateral Files

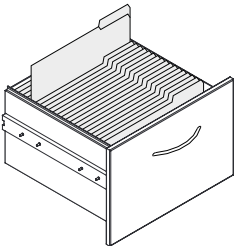

- Lateral files are available as freestanding or underdesk units;
- Full-extension ball-bearing slides on the drawers allow complete and unobstructed access with front-to-back or side-to-side filing rails to maximize the use of drawer filing space and to better organize documents;
- Units have a built-in anti-tilt mechanism, which only allows one drawer to be opened at a time for safety purposes. Lateral file case and fronts are constructed of thermally fused laminate. Drawer interiors in lateral files accept adjustable hanger bars for filing letter and legal hanging files;
- All lateral files come equipped with a locking mechanism. Stations can be keyed-alike upon request. Master keys are available for the facility manager;
- Lateral files have four, 1.5" levelling glides providing 1" of height adjustability;
- Crossbars are supplied for all lateral file cabinets.

Locks

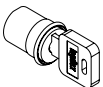

- Locks are standard with all drawers and cabinet doors, available in satin nickel and black, match to handle color;
- Locks are optional on hutches, wardrobes with laminate;
- For cabinets with PV glass doors locks are only available for 66" and 72" units;
- Locks are not offered on FL glass doors;

Grommets



- Standard black plastic grommet with the Logiflex logo engraved;
- 2-1/2" diameter cutout;
- Satin nickel and chrome grommets are available.

Levellers

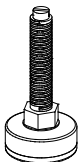

- All furniture items (except bridges) sit on adjustable levellers, 1" in diameter, allowing for up to 1" adjustment for the purposes of levelling the furniture;
- The standard finished height for work surfaces is 29".

Specific Characteristics by Product

Desks

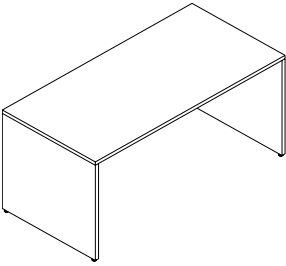

Manufacturing Standards:

- Desks consist of a work surface with two full end gables and modesty;
- Desks are delivered assembled with the exception of empty shells;
- Desks dimensions are:
 - Rectangular desks : 48" to 84" wide and 30" to 36" deep;
 - Convex desks : 60" to 84" wide and 30", 36" and 42" deep;
 - Extended desks : 66" to 84" wide and 48" and 54" deep;
 - Standard height is 29"
- Modesties:
 - Modesty standard is full height (FM);
 - Flush modesty for 24" desks;
 - 4-5/8" modesty recess for 30" desks;
 - 6" modesty recess for 36" desks;
- Levellers for height adjustment;
- Many desks offer factory installed pedestals and file drawers which include locks;
- Drawers have PVC extrusion for lateral opening of drawers;
- HJAB handles are standard with desks with pedestals.

Options:

- Short modesty (PM: 10") and medium modesty (SM: 18.5");
- Some desks offer a straight or curved minister modesty;
- Grommets are offered as an option on all desks with a choice of positions.

Note: For handles other than the standard HJAB, consult the [Color and Finishes Guide](#).

Returns

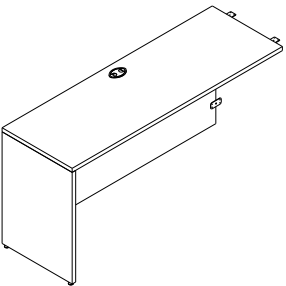

Manufacturing Standards:

- Returns consist of a work surface with one full end gable and modesty;
- Returns are delivered assembled with the exception of empty and reversible empty returns;
- Flush plates are included for installation to a free standing unit;
- Return dimensions are:
 - 30" to 60" wide and 20" to 24" deep;
 - Return pedestals range from 30" to 42" wide;
 - Standard height is 29"
- Levellers for height adjustment;
- Modesties are flush on all returns, the standard is full height (FM);
- Many returns offer factory installed pedestals and file drawers which include locks;
- Pedestal drawers have PVC extrusion for lateral opening of drawers;
- HJAB handles are standard with returns with pedestals;
- Grommet.

Options:

- Short modesty (PM: 10") and medium modesty (SM: 18.5");
- Handles are offered as an option, consult the Logiflex Color & Finishes Guide;
- Choice of grommet styles and positions.

Note:

- Returns are not compatible with lateral tables due to differences in the direction of the wood grain as well as the thickness of the modesty panel.
- For handles other than the standard HJAB, consult the [Color and Finishes Guide](#).

Bridges and Connection Tops

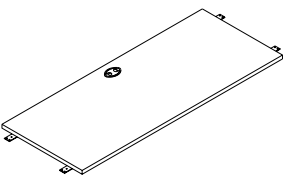

Manufacturing Standards:

- Bridges consist of a work surface and are delivered disassembled;
- Flush plates are included for installation to a free standing unit;
- Dimensions are:
 - Bridges range from 36" to 48" wide and 20" to 24" deep;
 - Connection tops range from 13" x 13" to 36" x 36"
- Modesties:
 - Bridges with modesties, standard is full height (FM);
 - Modesties are flush on bridges.
- Grommet.

Options:

- Short modesty (PM: 10") and medium modesty (SM: 18.5");
- Choice of grommet positions.

Note: Bridges are not compatible with lateral tables due to differences in the direction of the wood grain as well as the thickness of the modesty panel.

Tables

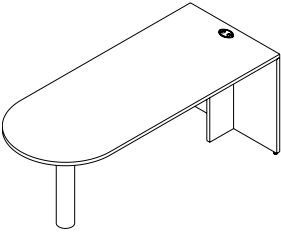

Manufacturing Standards:

- Free standing D, P, R and Q tables consist of a work surface with either one or 2 metal legs and one full end gables with or without a modesty;
- Table dimensions are:
 - Arched tables: 60" to 84" wide and 42" to 48" deep;
 - D, P, R and Q tables: 54" to 84" wide and 30" to 36" deep;
 - Extended tables: 60" to 84" wide and 48" and 54" deep;
 - Lateral tables: 24" to 84" wide and 20" to 36" deep;
 - Standard height is 29" and include levellers for height adjustment.
- Tables with modesties, the standard is full height (FM);
- Modesties are recessed:
 - 4-5/8" modesty recess for 30" desks;
 - 6" modesty recess for 36" desks.
- Corner tables offer full or half leg bases on either the left or right or both sides;
- Lateral tables offer a choice of full or a half leg on either the right or left side;
- Grommet offered on free-standing tables only.

Options:

- A 12" fixed shelf can be added 16" below the work surface as an option;
- Tables with modesties, short modesty (PM: 10") and medium modesty (SM: 18.5");
- Corner, extended corner and lateral tables offer a choice of grommet positions.

Note:

- D, P, R and Q tables are not compatible with lateral tables, due to difference in the direction of wood grain and the thickness of the end gable;
- A wide selection of metal leg styles is offered.

Pedestals and Cabinets

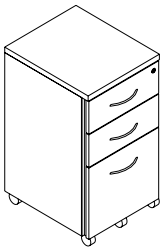

Manufacturing Standards:

- Pedestals and cabinets consist of a closed storage unit with either drawers or doors;
- Tops are 5/8" thick thermally fused laminate;
- Pedestals, file drawers and cabinets include locks;
- HJAB handles are standard on all pedestals and cabinets, with the exception of the mobile pedestals which offer handles as an option;
- Mobile pedestals include a PVC extrusion for lateral opening of drawers;
- Cabinets with doors include 1 adjustable shelf;
- File drawers and lateral file cabinets can accommodate both letter and legal format files;
- Drawer bottoms are 1/8" black masonite;
- Crossbars are supplied for all lateral file cabinets.

Options:

- Legal format drawers for independent and factory installed D, E and F pedestals;
- Metal legs can be added under cabinets.

Note: For handles other than the standard HJAB, consult the [Color and Finishes Guide](#).

Credenzas

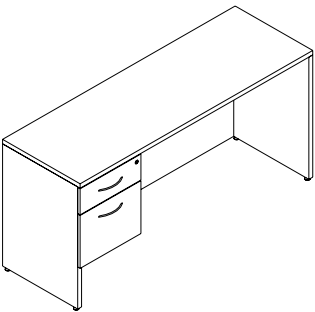

Manufacturing Standards:

- Credenzas consist of a surface and one or more closed storage units with either drawers or doors;
- Credenza dimensions are:
 - 54" to 84" wide and 20" to 24" deep;
 - Standard height is 29"; the server credenza is 36" H;
- Cabinets with doors include 1 adjustable shelf for 20" H units and 2 adjustable shelves for 36" H units;
- Modesties:
 - Credenzas with modesties, the standard is full height (FM);
 - Flush Modesty;
- Credenza file drawers and cabinets include locks;
- HJAB handles are standard;
- File drawers and lateral file cabinets can accommodate both letter and legal format files;
- Drawer bottoms are 1/8" black masonite;
- Crossbars are supplied for all lateral file cabinets.

Options:

- Short modesty (PM: 10") and medium modesty (SM: 18.5");
- Grommets and choice of grommet positions.

Note: For handles other than the standard HJAB, consult the [Color and Finishes Guide](#).

Hutches

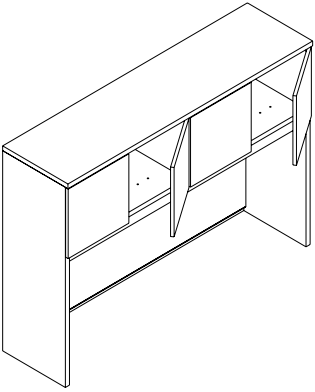

Manufacturing Standards:

- Hutches are storage units that are either affixed to the wall or include supporting legs and may or may not have doors;
- Hutch dimensions are:
 - All hutches are 16" deep;
 - Cabinet Hutches range from: 18" to 24" wide and 30" to 42" wide;
 - Wall and Desk Hutches : 30" to 84";
 - Heights offered are 37", 43" and 55"
- There are 4 types of doors available:
 - Retractable doors;
 - Laminate doors: the number of doors vary depending on the length of the hutch or cabinet;
 - 2" wide glass satin nickel aluminium frame doors;
 - Thin frame 5/32" aluminum-frame doors.
- The number of doors vary depending on the length of the hutch or cabinet;
- Wall and desk may also have pigeon hole units;
- Wall hutch leg base standard is 2 full leg;
- Wall and desk hutches include a task light concealer;
- Wall and desk hutches include pre-drilled holes for wire dividers;
- Desk hutches include flexible grommet on back;
- All wall hutches come standard with Z-Bars for wall mounting.

Options:

- Desk hutches offer the option to have a tackboard under the hutch unit;
- Locks are offered as an option on all hutches with the exception of thin framed glass doors models;
- Half legs;
- Selection of glass finishes and colors available;
- Handles are offered as an option on all hutches with doors;
- Wire dividers.

Bookcases

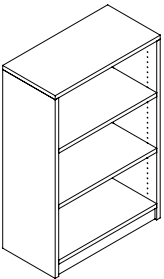

Manufacturing Standards:

- Bookcases are shelving units with adjustable shelves;
- 1" thick laminate shelves;
- Backs are either thermofused laminate (TFL) - 5/8" high-density particle board or black Masonite;
- Bookcase dimensions are:
 - 30" or 36" wide and 12" - 20" deep;
 - Height ranges from 29" to 84" high;
- Shelves are adjustable and include brackets.

Options:

- Additional 1" thick laminate shelves.

Wardrobes

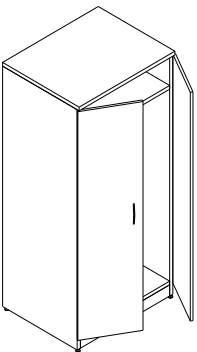

Manufacturing Standards:

- Wardrobes are upright storage units with doors, one fixed shelf and a clothes rail;
- Wardrobe dimensions are:
 - 30" to 42" wide and 20" to 24" deep;
 - Heights range from 29" to 84" high.
- Laminate or glass doors;
- Locks:
 - Standard on all laminate cabinets that are 72" or less;
 - Not available on thin framed glass doors models;
- Clothes rail;
- Wardrobes may include pedestals and adjustable shelves;
- Ventilation grill on the back;
- Handles:
 - HJAB handles are standard on wardrobes;
 - Thin frame doors include built-in aluminum handles.
- Shelf brackets are included.

Options:

- Metal legs are available;
- Locks offered as option on the 2" aluminium frame cabinet doors that are 72" or less.

Note: For handles other than the standard HJAB, consult the [Color and Finishes Guide](#).

Cabinets

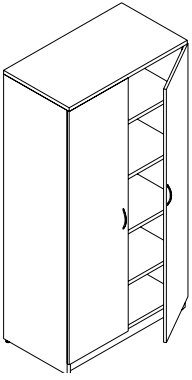

Manufacturing Standards:

- Cabinets are upright storage units with doors adjustable shelves;
- Cabinet dimensions are:
 - 30" to 42" wide and 20" to 24" deep;
 - Heights range from 29" to 84" high.
- Cabinets include 1 adjustable shelf for 20" H units and 2 adjustable shelves for 36" H units;
- Laminate or glass doors;
- Adjustable shelves are standard and the number of shelves vary depending on height;
- Locks:
 - Standard on all laminate cabinets that are 72" or less;
 - Not available on thin framed glass doors models;
- Handles:
 - HJAB handles are standard;
 - Thin frame doors include built-in aluminum handles.
- Shelf brackets are included.

Options:

- Metal legs are available;
- Additional 1" thick laminate shelves;
- Locks offered as option on the 2" aluminium frame cabinet doors that are 72" or less.

Note: For handles other than the standard HJAB, consult the [Color and Finishes Guide](#).

Multiple Units

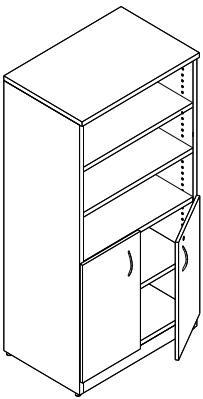

Manufacturing Standards:

- Multiple units are upright storage units with a combination of open or closed storage and shelving;
- Multiple unit dimensions are:
 - 30" to 42" wide and 20" to 24" deep;
 - Heights range from 29" to 84" high;
- Laminate or glass doors;
- Adjustable shelves are standard and the number of shelves vary depending on height;
- Locks:
 - Standard on all laminate doors and drawers;
 - Not available on thin framed glass doors.
- Wardrobes include a ventilation grill on the back;
- Handles:
 - HJA are standard for multiple units;
 - Thin frame doors include built-in aluminum handles.
- Drawer bottoms are 1/8" black masonite;
- Metal legs are available;
- Shelf brackets are included.

Options:

- Additional 1" thick laminate shelves;
- Locks offered as option on the 2" aluminium frame cabinet doors that are 72" or less.

Note: For handles other than the standard HJA, consult the [Color and Finishes Guide](#).

Manufacturer Characteristics

Warranty

Logiflex guarantees to the original purchaser that Logiflex products are free from defects in design, materials and workmanship for the product's lifetime, with certain exceptions.

You may consult the full warranty on the website: [Logiflex Warranty](#)

Indoor Advantage Gold

Logiflex manufactures its products in North America and are certified for low chemical emissions with Indoor Advantage Gold.

As our product line is constantly evolving and expanding, we recommend that you visit logiflex.ca for updates.

logiflex

1235 St-Roch N., Sherbrooke QC J1N 0H2 Canada
T : 1.877.864.9323 | F : 1.800.474.7830 | logiflex.ca

