

## Collection Characteristics

### The Core of the Product

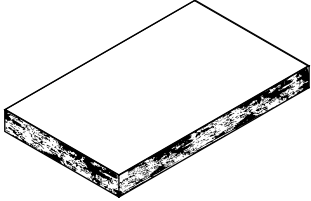

- Logiflex uses high pressure laminate and thermally fused laminate to build its laminate case good products;
- Both high pressure laminate and thermally fused laminate products are constructed from an ANSI A208 Approved standards. Logiflex chooses to use Uniboard M-2 materials that have a density range of 630-710 kg/m<sup>3</sup>; a thickness tolerance of +/- 0.200mm to +/- 0.100mm for precision, screw holding face at a rate of 202 lbs, a core value of 180 lbs and an emissions record of less than 0.09 ppm.

### Desktops, Tabletops, Countertops and Filing and Storage Tops

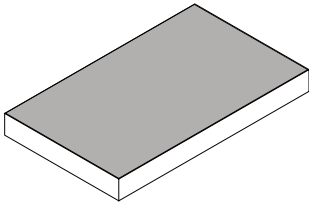

- All Level worksurfaces and tabletops, as well as filing and storage tops are 1" thick thermally fused laminate or high pressure laminate with 45-lb/cu ft density industrial grade composite wood core;
- Work surfaces are available in a choice of over 25 standard laminates. Custom laminates are available upon request;
- Surfaces are finished with 2mm heat sealed PVC edge banding in a choice of matching or complimentary colors. All wood grain laminates have a matching wood grain vinyl trim as a standard;
- Grommet covers are metal.

### Metal Handles and Assorted Legs

- The shape and metal finish for handles and assorted legs are designed for a harmonious look;
- The metal handles and legs are offered with a standard chrome finish. Satin Nickel finish is offered as an option.

### Assembly

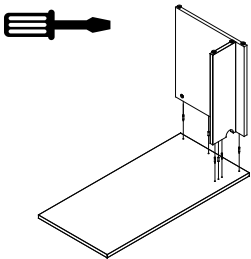

- Overhead hutches ship assembled;
- Desks that include storage will ship assembled. Assembled goods will be palletized with protective corners and shrink-wrapped;
- Desks and bridge surfaces that do not contain a storage unit will require some assembly on-site. Non-assembled goods will be packaged and shipped on pallets. Installation instructions are also available;
- Surfaces have the ability of be supported by a pedestal, metal leg or gable support.

### Gable Supports

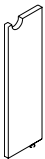

- Gables are 1" thick thermally fused laminate or high pressure laminate with 45-lb/cu ft density industrial grade composite wood core;
- Gable supports are specified as part of the overall configuration;
- Partial gables include a grommet for wire management;
- Gables come with a 1.5" levelling glides providing 1" of height adjustability to the desk.

## Cushions

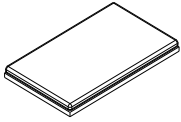

- Cushions are upholstered with commercial grade materials;
- 1" Velve foam;
- 2.7 lb density/60lb compression.

## Desk Supports

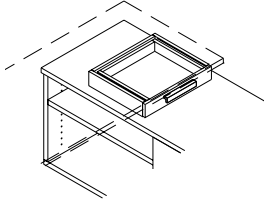

- Laminate construction;
- Optional drawer with ball bearing slides.

## Lateral Files

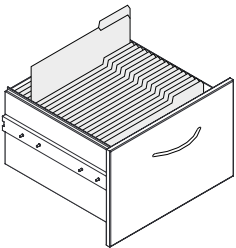

- Lateral files are available as freestanding or underdesk units;
- Full-extension ball-bearing slides on the drawers allow complete and unobstructed access with front-to-back or side-to-side filing rails to maximize the use of drawer filing space and to better organize documents. Legal and letter size documents can be filed either front-to-back or side-to-side within the drawer;
- Units have a built-in anti-tilt mechanism, which only allows one drawer to be opened at a time for safety purposes. Lateral file case and fronts are constructed of thermally fused laminate. Drawer interiors in lateral files accept adjustable hanger bars for filing letter and legal hanging files;
- All lateral files come equipped with a locking mechanism. Stations can be keyed-alike upon request. Master keys are available for the facility manager;
- Lateral files have four, 1.5" levelling glides providing 1" of height adjustability.

## Grommet and Communication Box Options

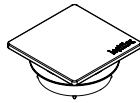

### CAPF Grommet

- Square metal grommet in a satin nickel finish. Two positions available, closed and open allowing for wire management.

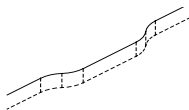

### WAV Cutout for Wires

- A cutout on the desk top allows for an esthetic and functional wire management solution.

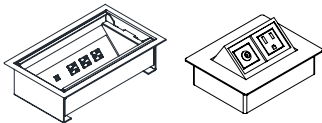

### Connection Units

- A number of pop-up connection units are offered to bring plug-in options to the desk top.



### QIBL Wireless Charger

- The QIBL wireless desk top charger available for Qi adapted devices. A L'unité de surface QIBL permet de charger sans fil les appareils munis du récepteur Qi.
- QIRE: Receiver to adapt devices not Qi compatible. Built-in connections for Apple 30 pin and lightning, Micro-USB.

## Storage Unit Electrical Wire Management

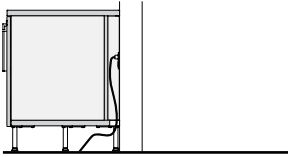

The high pedestal construction can be adapted to accommodate different electrical configurations of work stations:

### Wall Power

- Back recessed by 2" to clear wall outlets;
- WAV grommet in the base of the unit to pass cables.

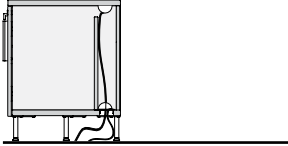

### Concealed Power

- Full back;
- Removable panel at the back of bookcase or open sections to access cables from the front of the unit;
- 2-1/2" round grommet in the base of the unit, on the left and right;
- Half-round grommet at the top and bottom of each division panel between each section of the unit.

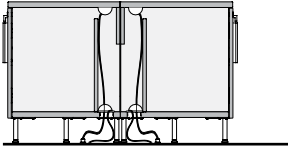

### Central Power

- Open back;
- Removable panel at the back of storage space to access cables from the front of the unit;
- 2-1/2" round grommet in the base of the unit, on the left and right;
- Half-round grommet at the top and bottom of each division panel between each section of the unit.

## Desks and Returns

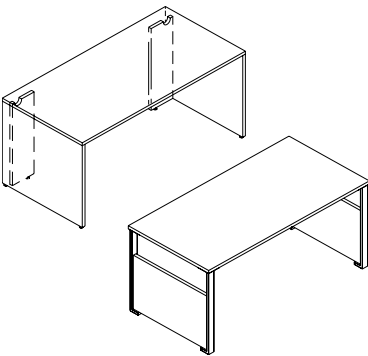

- All Level desks and returns are 1" thick thermally fused laminate or high pressure laminate with 45-lb/cu ft density industrial grade composite wood core;
- Desks consist of a work surface with two full end gables and optional modesty;
- Returns consist of a work surface with one full end gable and optional modesty;
- Desks are available in 24", 30" and 36" depths. All desk range in width starting at 30" and increase to a maximum size of 84";
- Metal legs are 16 gauge polished stainless steel or polished chrome;
- Desks and returns have adjustable 1.5" high leveling glides that provide up to 1" inch of adjustability.

## Bridges

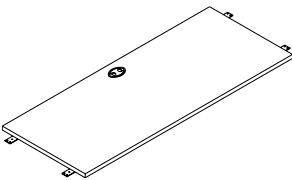

- Bridges are 1" thick thermally fused laminate or high pressure laminate with 45-lb/cu ft density industrial grade composite wood core;
- Bridge surfaces consist of a worksurface and an option of a full modesty, partial modesty or no modesty. Bridge surfaces are intended to be joined to an adjacent desk on either side and share the support gables of the adjacent desks;
- Grain direction on directional laminates runs the length of bridge;
- Bridges are available in 20" and 24" depths and widths ranging from 30" to 60" in 6" increments. Straight bridges are also available in 20" deep sizes;
- Support bar when 60" or longer;
- Metal grommet.

## Leg Base Storage

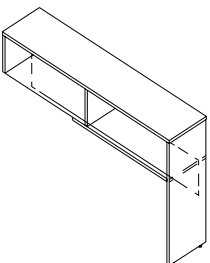

- Leg base storage are 1" thick thermally fused laminate or high pressure laminate with 45-lb/cu ft density industrial grade composite wood core;
- 10" modesty panel, 3" recessed;
- Depth of 16";
- Lengths of 66" and 72";
- Height: 42".

## Bookcases

---

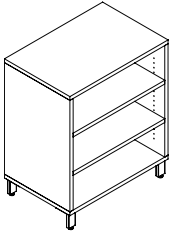

- Bookcases are 1" thick thermally fused laminate or high pressure laminate with 45-lb/cu ft density industrial grade composite wood core;
- Adjustable shelves;
- Heights: 29", 36", 42", 48", 51", 54", 60", 64", and 66";
- Depths and in widths of 30" or 36";
- Chrome finish metal legs;
- Bookcases have adjustable 1.5" high leveling glides that provide up to 1" inch of adjustability.

## Pedestals (Storage and Filing)

---

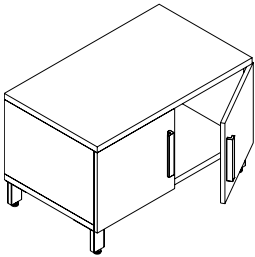

- A wide variety of laminate under desk and mobile pedestals are available;
- Pedestals are constructed of 5/8" thermally fused laminate;
- 18" and 23" depths;
- Pedestal bases have 4 adjustable 1.5" levelling glides providing 1" of height adjustability;
- Drawers have the capacity to support a load of up to 100 lbs;
- Drawers and slides are removable and interchangeable on-site;
- All Level pedestals come equipped with an optional lock;
- Offices can be keyed-alike upon request. Master keys are available for the facility manager;
- Pedestal file drawers can accommodate legal or letter size documents;
- Box and file drawers have full extension steel ball-bearing slides and the top box drawer in a box/box/file includes a pencil tray;
- Mobile pedestals come equipped with a fifth caster on the bottom drawer to ensure stability;
- Soft close doors.

## Wardrobe Towers

---

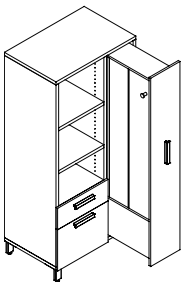

- Wardrobe Towers have a file drawer on one side and two box drawers on the other side with a lateral file drawer located below the box and file drawers and can be specified as right- or left-handed;
- Box drawers have full extension steel ball-bearing slides;
- Wardrobe Tower base has four adjustable 1.5" high leveling glides that provide up to 1" inch of adjustability;
- Drawer slides are used to attach the drawer to the case. Box and file drawer slides have the capacity to support a load of up to 100 lb. Lateral drawers can support load of up to 200 lb. Drawers and slides are removable and interchangeable on-site;
- Wardrobe Towers have optional locks. Stations can be keyed-alike upon request. Master keys are available for the facility manager.

## Hutches

---

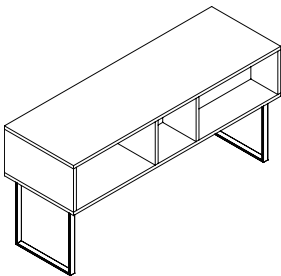

- Hutches are available to sit on desks, credenzas, and filing cabinets or mount to the wall.
- Hutch bodies are 1" thick and fabricated from thermally fused laminate with 45-lbs/cu ft. density industrial grade composite wood core;
- Hutch doors are available in either 5/8" thick thermally fused laminate with 45-lbs/cu ft. density industrial grade composite wood core, glass or optional textured acrylic doors with aluminum framing;
- Laminate hutch doors are finished in vinyl edge banding;
- Hutch doors can be ordered in a different color from the hutch body;
- Hutches are 16" and 24" deep and available in widths ranging from 60", 66" and 72".

## Divider Screens

---

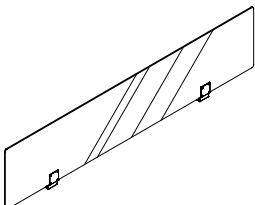

- Available in 1/4" and 3/8" Acrylic, 5/8" laminate and 7/8" thick tackboard covered with fabric;
- Chrome-finish metal mounts for under surface or surface mounting;
- Under surface mount heights: 10", 15", 21", 24" and 26";
- Surface mount heights: 15" and 21";
- Lengths: from 24" to 72" in 6" increments.

# Manufacturer Characteristics

---

## Warranty

---

Logiflex guarantees to the original purchaser that Logiflex products are free from defects in design, materials and workmanship for the products' lifetime. Effective as of the date invoiced to the distributor, the warranty is valid only for products bought new from an authorized Logiflex distributor and as long as the original purchaser owns the products. The warranty period will be reduced proportionately if the products are used over a period exceeding the equivalent of a shift of 40 hours/week.

This warranty applies only to normal use of the product and is limited to the repair or replacement of said product at Logiflex's discretion. All replacement parts will be shipped to the original shipping address. Transportation and labor are not covered by this warranty. By accepting the product at its delivery, the buyer accepts these conditions.

**Limited Lifetime Warranty:** Access, Knockout, Level, Logilife, Manhattan, Millenium, Réception et Tables (Conference, Occasional, Multimedia)

**5 Year Warranty:** Academic and Soft Seating

**10 Year Warranty:** Chairs

**This warranty does not apply to defects or damages resulting from:**

- Normal wear and tear occurring with the use of the product;
- Negligence, misuse, abuse or accident;
- Substitution, modification, transformation, repair, renovation or use of components or materials that have not been authorized by Logiflex;
- Renting to a third party;
- Natural properties of materials;
- For leather products: normal defects in leather such as: scars, marks or difference in stain within a leather skin or between different skins;
- Exposure to sunlight or environments with extreme temperature/humidity conditions;
- Damage caused by a carrier in transit, or delivery/installation contractors.

**This warranty does not include:**

- Parts and materials supplied by the customer (COM);
- Special finishes applied to Logiflex products;
- The matching of colors, grains or textures of wood due to its natural properties;
- Non-standard Logiflex products;
- Logiflex product not installed or used in accordance with the Logiflex installation guidelines;
- Bulbs and ballasts.

**Restrictions:**

- 1 year warranty on electrical components;
- 5 year warranty on seat mechanisms, drawer slides and locks;
- 5 year warranty on urethane parts;
- 5 year warranty on upholstery and casters

## Indoor Advantage Gold

---

Logiflex manufactures its products in North America and are certified for low chemical emissions with Indoor Advantage Gold.

logiflex

1235 St-Roch N., Sherbrooke QC J1N 0H2 Canada  
T : 1.877.864.9323 | F : 1.800.474.7830 | logiflex.ca

LOGIFLEX | LEVEL SPECIFICATION SHEET

